

UNCLASSIFIED

AD NUMBER

AD388748

CLASSIFICATION CHANGES

TO: UNCLASSIFIED

FROM: CONFIDENTIAL

LIMITATION CHANGES

TO:
Approved for public release; distribution is unlimited.

FROM:
Distribution authorized to U.S. Gov't. agencies and their contractors;
Administrative/Operational Use; 01 NOV 1967.
Other requests shall be referred to Assistant Chief of Staff for Force Development, Department of the Army, Attn: FOR-OT-RD, Washington, DC 20310.

AUTHORITY

31 Dec 1973 per document markings; AGO D/A ltr, 29 Apr 1980

THIS PAGE IS UNCLASSIFIED

THIS REPORT HAS BEEN DELIMITED
AND CLEARED FOR PUBLIC RELEASE
UNDER DOD DIRECTIVE 5200.20 AND
NO PESTRICTIONS ARE IMPOSED UPON
ITS USE AND DISCLOSURE,

DISTRIBUTION STATEMENT A

APPROVED FOR PUBLIC RELEASE;
DISTRIBUTION UNLIMITED,

GENERAL DECLASSIFICATION SCHEDULE

**IN ACCORDANCE WITH
DOD 5200.1-R & EXECUTIVE ORDER 11652**

THIS DOCUMENT IS:

CLASSIFIED BY _____

**Subject to General Declassification Schedule of
Executive Order 11652-Automatically Downgraded at
2 Years Intervals- DECLASSIFIED ON DECEMBER 31, 73.**

BY

**Defense Documentation Center
Defense Supply Agency
Cameron Station
Alexandria, Virginia 22314**

SECURITY

MARKING

The classified or limited status of this report applies to each page, unless otherwise marked.

Separate page printouts MUST be marked accordingly.

THIS DOCUMENT CONTAINS INFORMATION AFFECTING THE NATIONAL DEFENSE OF THE UNITED STATES WITHIN THE MEANING OF THE ESPIONAGE LAWS, TITLE 18, U.S.C., SECTIONS 793 AND 794. THE TRANSMISSION OR THE REVELATION OF ITS CONTENTS IN ANY MANNER TO AN UNAUTHORIZED PERSON IS PROHIBITED BY LAW.

NOTICE: When government or other drawings, specifications or other data are used for any purpose other than in connection with a definitely related government procurement operation, the U. S. Government thereby incurs no responsibility, nor any obligation whatsoever; and the fact that the Government may have formulated, furnished, or in any way supplied the said drawings, specifications, or other data is not to be regarded by implication or otherwise as in any manner licensing the holder or any other person or corporation, or conveying any rights or permission to manufacture, use or sell any patented invention that may in any way be related thereto.



CONFIDENTIAL
 DEPARTMENT OF THE ARMY
 OFFICE OF THE ADJUTANT GENERAL
 WASHINGTON, D.C. 20310

19

IN REPLY REFER TO

AGAM-P (M) (27 Feb 68) FOR OT RD-674201

5 March 1968

SUBJECT: Operational Report - Lessons Learned, Headquarters, 8th
 Battalion (175mm)(SP), 4th Artillery, Period Ending 31 October 1967 (U)

TO: SEE DISTRIBUTION

1. Subject report is forwarded for review and evaluation in accordance with paragraph 5b, AR 525-15. Evaluations and corrective actions should be reported to ACSFOR OT RD, Operational Reports Branch, within 90 days of receipt of covering letter.

2. Information contained in this report is provided to insure appropriate benefits in the future from lessons learned during current operations and may be adapted for use in developing training material.

BY ORDER OF THE SECRETARY OF THE ARMY:

Kenneth G. Wickham

KENNETH G. WICKHAM
 Major General, USA
 The Adjutant General

1 Incl
 as

DISTRIBUTION:

Commanding Generals

- US Continental Army Command
- US Army Combat Developments Command

Commandants

- US Army Command and General Staff College
- US Army War College
- US Army Adjutant General School
- US Army Air Defense School
- US Army Armor School
- US Army Artillery and Missile School
- US Army Aviation School
- US Army Chemical School
- US Army Civil Affairs School
- US Army Engineer School
- US Army Infantry School
- US Army Intelligence School

*This document contains information affecting the National
 Defense of the United States within the meaning of the
 Espionage Laws, Title 18, U. S. C., Sections 793 and 794,
 its transmission or the revelation of its contents in any
 manner to an unauthorized person is prohibited by law.*

REGRADED UNCLASSIFIED
 WHEN SEPARATED FROM
 CLASSIFIED INCLOSURES

AD388748

CONFIDENTIAL

APR 2 1968
 RECEIVED

CONFIDENTIAL

DISTRIBUTION (Cont'd)

US Army Medical Field Service School
US Army Military Police School
US Army Missile and Munitions School
US Army Ordnance School
US Army Quartermaster School
US Army Security Agency School
US Army Signal School
US Army Southeastern Signal School
US Army Special Warfare School
US Army Transportation School

Copies furnished:

Office, Chief of Staff, US Army
Deputy Chiefs of Staff
Chief of Research and Development
Chief of Engineers
Assistant Chiefs of Staff
The Surgeon General
The Provost Marshal General
Research Analysis Corporation (Library)
Dr. Martin J. Bailey, OSD(SA)
Defense Documentation Center
Director, Weapons Systems Evaluation Group
CG, US Army Weapons Command
Commanding Officers
4th Brigade, 6th Infantry Division
1st Battalion, 82d Artillery
8th Battalion, 4th Artillery
Office of the Director of Defense Research and Engineering

CONFIDENTIAL

CONFIDENTIAL

HEADQUARTERS
8TH BATTALION (175MM)(SP) 4TH ARTILLERY
APO 96269

1 November 1967

SUBJECT: Operational Report for Quarterly Period Ending 31 October 1967 (U)

TO: See Distribution

SECTION I. SIGNIFICANT UNIT ACTIVITIES

1. (U) General.

a. Predeployment Activities

(1) The 8th Battalion (175mm) (SP), 4th Artillery, was activated at Fort Sill, Oklahoma, on 15 March 1967 by General Orders Number 25, Headquarters, U. S. Army Artillery and Missile Center, dated 31 January 1967.

(2) The battalion was organized under TO&E 6-435D (See Enclosure 1) less an organic aviation section, and augmented by a meteorological section, a liaison section, and 6 forward observer sections.

(3) A formal 8-week Intensified Combat Training Period (ICTP) was initiated on 17 April 1967. Training progressed on schedule and was successfully terminated with a Battalion Training Test administered by the 1st Field Artillery Brigade on 8-9 June 1967.

b. Movement Overseas.

(1) Preparation for Overseas Movement (POM) began on 12 June 1967 and was completed without difficulty and well within the allotted time period.

(2) Equipment was shipped from Fort Sill according to the following schedule:

<u>TYPE CARGO</u>	<u>CONTENTS</u>	<u>WEIGHT(Tons)</u>	<u>DATE SHIPPED</u>
General cargo	All vehicular equipment 89 Conex containers	1528	3 July 1967
Red Disk TAT	12 Conex containers 87 Conex inserts	48	14 July 1967
Advance party equipment	52 Conex inserts	15	6-7 August 1967

FOR OTRD
674201

CONFIDENTIAL

*Downgraded at 8 year intervals
Declassified after 18 years
DOD DIR 5200.10*

CONFIDENTIAL

1 November 1967

SUBJECT: Operational Report for Quarterly Period Ending 31 October 1967 (U)

(3) The main body of the battalion departed Fort Sill by air on 24 July 1967 and subsequently sailed from Tacoma, Washington, aboard the USNS General Upshur on 25 July 1967. Orders were received enroute changing the unit's port of debarkation in the Republic of Vietnam from Qui Nhon to Da Nang.

(4) An advance party of 27 personnel departed Tinker Air Force Base, Oklahoma City, aboard two C-130 aircraft on 6 and 7 August respectively.

c. Arrival In-Country

(1) The two elements of the advance party arrived at the Air Force Freight Terminal at Da Nang on 9 and 10 August, respectively. The main body arrived on 12 August and disembarked at Red Beach northwest of Da Nang.

(2) The battalion staff worked directly with Headquarters, III Marine Amphibious Force to arrange for troop billeting, rations, unloading of personnel and equipment, and movement of the battalion to its assigned areas of operations. At the request of the Battalion Commander, Da Nang Sub-Area Command provided a secured equipment staging area near the port facilities.

(3) The bulk of the general cargo, which arrived 10 August, was unloaded at the deep water pier northeast of Da Nang and moved to a battalion staging area southwest of the city. Tracked vehicles were off-loaded onto LCU's and transferred to the bridge ramp pier in Da Nang. Unloading operations were completed by 12 August. The processing and rearrangement of equipment into a tactical configuration was completed on 15 August.

(4) B Battery was placed under the operational control of the 1st Marine Division. The battery moved into position 4 kilometers west of Red Beach and began firing on 15 August.

(5) The remainder of the battalion was placed under the operational control of the 3rd Marine Division and moved by sea and overland convoy to Dong Ha, 18 kilometers south of the Demilitarized Zone. The firing elements of A and C Batteries were in position and firing on 17 August. All elements of the battalion were in position by 18 August.

2. (C) Intelligence.

2

CONFIDENTIAL

CONFIDENTIAL

1 November 1967

SUBJECT: Operational Report for Quarterly Period Ending 31 October 1967 (U)

a. Weather and terrain (see Inclosure 2).

(1) Throughout August and the first half of September, the weather in the Dong Ha area was generally hot and dry with winds from the west and southwest. During the latter half of September and throughout October the winds came generally from the east bringing slightly cooler temperatures and a sharp increase in precipitation. Severe rains, with 18 inches recorded during one 3-day period (16-18 September), hindered normal operations and caused gun emplacements to deteriorate rapidly. Severe erosion of gun positions coupled with deep mud made it extremely difficult to maintain stable firing positions.

(2) B Battery has experienced predominantly hot, dry weather with the occasional violent thunderstorms prevalent in the Da Nang area. The soil, primarily sand, has provided an excellent surface for gun positions but the high water table (approximately 2 feet below the surface) precluded construction of underground facilities in the area.

b. Observation

(1) The six forward observer sections assigned to the battalion have seen only limited use as such. They have been used primarily to augment battalion and battery Fire Direction teams. On two occasions, forward observer parties accompanied ARVN units during operations in the coastal area north of the Cua Viet River and east of Route 1.

(2) Flying conditions have been generally favorable for aerial observation during the reporting period. Air has been the primary means for observing fire missions and registrations, although aerial observation has been limited on occasions by a shortage of aircraft.

c. Metro.

(1) The battalion meteorological section has performed with exceptional efficiency and has experienced no significant problems to date.

(2) In addition to serving this battalion, the meteorological section has been providing three 10-line NATO and 9-line computer metro messages daily to the following units:

CONFIDENTIAL

1 November 1967

SUBJECT: Operational Report for Quarterly Period Ending 31 October 1967(U)

- (a) 1st Battalion, 40th Artillery (Army)
- (b) Provisional (155mm)(SP) Howitzer Battery (Marine)
- (c) 1st 8" Howitzer Battery (Marine)
- (d) Combined Artillery Battalion (Army and Marine)

at Gio Linh

- (e) 1st Battalion, 11th Marines
- (f) 8th TAB, 26th Artillery (Army)
- (g) 2nd Battalion, 12th Marines
- (h) 30th Weather Squadron (Air Force)
- (i) Marine Auxiliary Air Group 36
- (j) Marine Air Base Squadron 36
- (k) Naval ships firing in the vicinity of the

Demilitarized Zone.

d. Enemy activity.

(1) The battalion came under hostile fire for the first time on 28 August when NVA artillery, in four separate attacks, fired some 90 140mm rockets and 152mm artillery rounds at the Dong Ha Combat Base. Approximately 20-25 artillery rounds hit in the vicinity of the battalion perimeter resulting in minor damage to tentage.

(2) A platoon (2 guns) of B Battery received a rocket attack on 2 September. Two 5-ton trucks were destroyed as a result of a direct hit on one of the vehicles and a third truck was slightly damaged.

(3) A second artillery attack on the Dong Ha Combat Base on 3 September left the immediate area of the battalion untouched, but virtually destroyed the main base ammunition dump.

(4) On 9 October, a 5-ton truck from A Battery, traveling in convoy from Dong Ha to Quang Tri City, was heavily damaged by the side blast from a mine struck by another vehicle heading in the opposite

CONFIDENTIAL

1 November 1967

SUBJECT: Operational Report for Quarterly Period Ending 31 October 1967 (U)

direction. The driver and one other passenger in the A Battery vehicle were slightly injured but immediately returned to duty.

(5) On 13 October, a temporary position area occupied by a platoon of C Battery north of Quang Tri City (YD314556) was attacked with 82mm mortars. The battery sustained no casualties or damage.

(6) On 29 October, the Dong Ha Combat Base again came under NVA artillery fire on four separate occasions with some 40-50 rounds impacting in or near positions occupied by the battalion. One 175mm gun (A Battery) was put out of action for three hours because of damage to the hydraulic lines. Two 2 1/2-ton trucks and three 3/4-ton trucks (Headquarters Battery) received moderate to light damage. In addition, the 2 1/2-ton metro van was slightly damaged, and several tents, conexes, and bunkers were struck by shell fragments. Three personnel received minor wounds from fragments and four others were injured as a result of accidents which occurred while they were running for cover.

(7) On 31 October, 15 rounds were fired at A Battery from an 82mm mortar located approximately 1000 meters north of the battery's position. Only one round is known to have impacted within the battery perimeter. One 3/4-ton truck sustained a cracked windshield.

(8) On ten other occasions throughout the period, elements of the battalion were subjected to light harrassing fire from both artillery and mortars.

(9) Although North Vietnamese and Viet Cong units are known to be operating in close proximity to the Dong Ha Combat Base, no ground attacks have yet been attempted against the perimeter itself.

3. (C) Operations and Training Activities.

a. Plans.

(1) 3rd Marine Division OPLAN 59-67.

(2) A plan is under consideration to relocate C Battery from its present position (YD221589) to C1 (vic YD206675) in conjunction with two M-110's from the Marine 1st 8" Howitzer Battery. This move would provide an additional 10,000 meter range capability against targets in North Vietnam.

b. Operations.

CONFIDENTIAL

4

CONFIDENTIAL

1 November 1967

SUBJECT: Operational Report for Quarterly Period Ending 31 October 1967 (U)

(1) All elements of the battalion have been continuously engaged in combat operations against the enemy since their arrival in-country. Throughout this period, the battalion (- B Battery), located at Dong Ha, has been supporting the 3rd Marine Division under the operational control of the 12th Marine Regiment. B Battery, located near Da Nang, has been supporting the 1st Marine Division under the operational control of the 11th Marine Regiment.

(2) On the morning of 15 August, B Battery moved from its staging area in Da Nang to an initial position at AT918795, approximately 4000 meters west of Red Beach. The firing elements of the battery proceeded from the Bridge Ramp in Da Nang to Red Beach by LCU, thence overland to the position area. The remainder of the battery proceeded overland from the battalion staging area southeast of Da Nang. The battery fired its first mission, a precision registration, at 1300 hours that same day.

(3) The following day, 16 August, one platoon (2 guns) from B Battery displaced to Hill 65 (AT878576), approximately 10,000 meters southwest of Da Nang.

(4) On the evening of 16 August, the firing elements of A and C Batteries departed Da Nang aboard LCU's and arrived at Dong Ha at various times between 0900 and 1600 hours the following day. A Battery occupied a position at YD208596 which had just been vacated by B Battery, 2nd Battalion, 94th Artillery. C Battery occupied previously unused terrain at YD222590. The first mission from Dong Ha, a precision registration, was fired by A Battery at 1815 hours, 17 August. The second round of this mission resulted in large secondary explosions in the target area.

(5) Headquarters, Service, and the remainder of A and C Batteries proceeded to Dong Ha by armed convoy, arriving at 1230 hours, 18 August 1967. Headquarters and Service Batteries occupied positions at YD223587 and YD224586 respectively, adjacent to C Battery.

(6) The platoon of B Battery located on Hill 65 proved extremely difficult to support logistically because of the steep terrain on which the position was located, the poor condition of the roads leading into the area, and the relatively long distances from supporting organizations at Da Nang. Control was complicated by the inability of the Battery Commander to establish reliable communications between the two portions of the battery by either radio or land line. The situation was rectified on 23-24 September, when both elements of the battery were united in a new permanent position at AT988674.

CONFIDENTIAL

9

CONFIDENTIAL

1 November 1967

SUBJECT: Operational Report for Quarterly Period Ending 31 October 1967 (U)

(7) On 11 October, one platoon from C Battery displaced to YD314550 just north of Quang Tri City in order to provide artillery coverage for a radio relay station some 30,000 meters to the south during the opening phase of Operation "Medina." The platoon was assigned a reinforcing mission in support of the 1st Battalion, 11th Marines, during this operation. The platoon returned to its original position at Dong Ha on 19 October.

(8) On 23 October, one platoon from B Battery displaced to AT919801 to provide support for Operation "Knox". The platoon returned to its original position on 31 October.

(9) Since arriving in Dong Ha on 17 August, A and C Batteries have fired 19,458 rounds in support of 3rd Marine Division operations and an additional 624 rounds in support of ARVN forces. 14,583 of these rounds have been fired at targets in and north of the Demilitarized Zone. During the period 10 September-7 October, more than 7,000 rounds were fired against NVA forces concentrated against the Marine outposts at Con Thien and Gio Linh. C Battery alone fired 518 rounds on the 14th of September. Firing reached its peak during the first week in October when the two firing batteries at Dong Ha averaged 420 rounds per day as compared to an overall battalion average of 272 rounds per day since arrival in-country.(see Inclosure 3).

(10) Since 15 August, B Battery has fired 6,664 rounds in support of 1st Marine Division operations in the Da Nang area (see Inclosure 3). Since the NVA rocket attack on Da Nang on 2 September, the 11th Marines have developed and pursued an aggressive counter-battery program in which B Battery has played a prominent part. B Battery has received considerable praise for its speed and accuracy, frequently exceeding that of light artillery units in the area.

(11) It is interesting to note that of the 3064 missions fired during this period by the two batteries at Dong Ha, only 194 (6%) have been observed. Of these 194, approximately one-third have been registrations or other non-destructive missions such as "spotter rounds" for reconnaissance inserts. Similarly, only 60 of the 2124 missions (3%) fired by B Battery have been observed. Fewer than 50% of these have been against known or suspected enemy targets. Lack of aircraft for air observation has been a primary restricting factor, especially in the area of the Demilitarized Zone where ground observation is limited.

(12) Since arriving in-country, battery and battalion FDC's have continuously operated on a 24 hour a day basis. Check charts are used at both levels. The number of FDC personnel authorized by TO&E is

CONFIDENTIAL

12

CONFIDENTIAL

1 November 1967

SUBJECT: Operational Report for Quarterly Period Ending 31 October 1967(U)

insufficient for this purpose and the battalion has been obliged to use survey and forward observer personnel to augment FDC teams. When firing batteries have split into separate platoons operating independently, additional personnel have been provided to the battery FDC's by the battalion FDC.

c. Training.

(1) During the first 45 days in-country, training was heavily oriented toward familiarizing the individual with the policies, ground rules, and additional skills applicable to a new and unfamiliar environment. Instruction, while closely supervised, was informal in nature, and was scheduled primarily on the basis of immediate needs. The following subjects were stressed:

- (a) Perimeter defense.
- (b) Handling and use of the Claymore mine.
- (c) Rules of engagement.
- (d) Familiarization firing (and test firing) of organic small arms and crew served weapons.
- (e) Artillery safety procedures.
- (f) Alert warnings and procedures.
- (g) Convoy security.
- (h) Maintenance of vehicles and equipment.
- (i) Section drill (FDC's and gun sections).
- (j) Communications procedures and security.

(2) A quarterly training program based on USARV Regulation Number 350-1 was published by the battalion headquarters, effective 1 October. This program provides for 168 hours of training varying between 10 and 14 hours per week. Each battery is required to publish a weekly training schedule based on these requirements. Character Guidance and weapons familiarization are scheduled monthly by the Battalion S3 section.

(3) The battalion Tactical SOP, which provides the basis of

11

CONFIDENTIAL

1 November 1967

SUBJECT: Operational Report for Quarterly Period Ending 31 October 1967 (U)

much of the unit's training, was completely revised to conform to in-country requirements on 1 October.

4. (U) Logistics.

a. General

(1) Difficulties did not occur in the shipment of equipment and supplies until arrival in-country. A large quantity of wheeled vehicles were dented and scraped while being unloaded at the deep water pier in Da Nang. However, no equipment or supplies were shipped on truck beds, therefore pilferage was not prevalent. Several conex containers were found to have been opened, but no equipment was missing.

(2) In preparing for the movement from Da Nang, most of the conexes were re-loaded on naval landing craft. To meet weight specifications, some conexes had to be reopened. This resulted in some mixing of equipment and attendant confusion when the conexes arrived in the position area.

b. Repair Parts.

(1) Since the battalion arrived at Dong Ha, the resupply of tank-automotive repair parts, other than deadline items, has been slow. Less than 5% of requisitioned parts have been received. As of 31 October, 80% of authorized PLL line items were at 100% fill.

(2) PLL, with the exception of communications PLL, is currently being maintained at battery level.

c. Resupply of Class II.

(1) As of 31 October, less than 30% of equipment requisitioned for replacement and initial issue had been received. Important items, such as cold weather individual clothing and space heaters for living tents were carried as "due out". Replacement of combat loss equipment, on the other hand, has been quite satisfactory. Three M54A2 5-ton trucks have been destroyed and two were replaced within one week. As of 31 October, one replacement truck was still "due out."

(2) Experience indicates that supplies from Da Nang Sub-Area Command are frequently not received in quantities equal to those listed on issue documents. Each month, a representative from the S4 purifies the document register with records maintained at Da Nang Sub-

12

1 November 1967

SUBJECT: Operational Report for Quarterly Period Ending 31 October 1967 (U)

Area Command. As of 31 October, 13 separate line items had been shipped which did not arrive in the quantities indicated. In many cases supplies are received without shipping documents. This problem has been brought to the attention of the supply facility at Da Nang Sub-Area Command.

(3) Resupply of routine items has been slow. Critical supplies such as POL and ammunition frequently tie up available transportation. In addition, harassment of river transportation and the occasional requirement to off-load and reload supplies onto smaller craft at the mouth of the Gua Viet River have caused unpredictable delays which disrupt the supply system.

d. Construction of firing pads for the eight 175mm guns located at Dong Ha began on 22 September 1967. As of 26 October, one pad was completed, two were partially completed, and earth work was prepared for another two. A Company, 3rd Engineer Battalion (Marine), is constructing the pads while materials are being provided through Army channels. A shortage of suitable materials has hampered construction and steps have been taken to decrease the size of the pads in order to conserve materials. A number of command and staff visits have been made to Da Nang Sub-Area Command to procure urgently required materials. The most difficult items to obtain are 6x12 inch, 4x12 inch and 2x12 inch lumber for pad decking. A portion of the materials, such as drift pins, nails and reinforcing rods, used so far have been acquired from local sources in order to continue construction. Marine Engineers plan to complete construction of the pads on 18 November if materials are available.

e. Maintenance Support and Supply.

(1) Thirty-five elevating differentials and six traversing assemblies on the M107 failed during the period covered by this report. The problem was traced by battalion maintenance personnel to improper torque adjustments on elevating and traversing slip-clutches (normally a support maintenance function). This adjustment is now being accomplished by organizational mechanics using locally fabricated tools and adapters.

(2) Available support maintenance is generally excellent. Generally speaking, the direct support maintenance facility at Dong Ha has an adequate stock of repair parts (third echelon) and down time for artillery and vehicles has been kept at a minimum.

(3) Second echelon repair parts, however, have been in short supply in the Dong Ha area. All requisitions for such parts are submitted through a local logistics task force to Da Nang. Only three

13

1 November 1967

SUBJECT: Operational Report for Quarterly Period Ending 31 October 1967 (U)

shipments of parts have been received to date. In most cases, no documents are received with supplies, thus complicating the supply accounting system.

(4) The battalion has changed 52 175mm tubes and 16 breech rings since arrival in-country.

(5) Average daily deadline status of tank-automotive equipment since arrival in-country is as follows (see Inclosure 4):

Track Vehicle 3.5% Daily

Wheel Vehicle 4.5% Daily

f. Base Construction.

(1) Immediately upon arrival in position, heavy and continuing emphasis was placed on base camp construction. Construction priorities were established as follows:

- (a) Base camp defensive perimeter.
- (b) Immediate protection for tactical operating elements.
- (c) Immediate protection for billeting and administrative facilities.
- (d) Construction of permanent bunkers and emplacements for tactical operations and command elements.
- (e) Construction of protected semi-permanent billeting and administrative facilities above ground.
- (f) All other.

(2) With the exception of gun pads, the construction of all basic tactical, administrative, and billeting facilities has been virtually completed.

5. (U) Civil Affairs.

a. The battalion has been assigned no specific area of responsibility for civil affairs.

b. The battalion, however, assisted the 2nd Battalion, 12th

CONFIDENTIAL

1 November 1967

SUBJECT: Operational Report for Quarterly Period Ending 31 October 1967 (U)

Marines, with a MEDCAP program in the Cam Lo area.

b. In addition, a project to establish a pig farm in the village of Thon Thie Trang has been initiated.

6. (C) Personnel.

a. Since arriving in-country, the battalion has been attached to Headquarters, 1st Field Forces Vietnam Artillery (Forward) for administration.

b. Strength:

(1) Authorized vs assigned since arrival in-country:

	Authorized	Assigned 12 August	Assigned 31 October
Officer	32	32	31
Warrant Officer	4	4	4
EM	524	502	526
Total	562	538	561

(2) Gains vs losses since arrival in-country:

	Gains	Losses	Net gain (loss)
Officer	4	5	(1)
Warrant Officer	0	0	0
Enlisted	39	15	24
Total	43	20	23

c. Casualties since arriving in-country:¹

Killed in action	-0
Died of battle wounds	-0
Wounded in action	-5 (all minor wounds)
Missing in action	-0

1. Source: USARV Form 130-R (Casualty Report)

CONFIDENTIAL

13-
CONFIDENTIAL

1 November 1967

SUBJECT: Operational Report for Quarterly Period Ending 31 October 1967 (U)

Non-battle casualties -1

Total -6

d. The skills of replacement personnel have not been consistent with those requisitioned. For example, requisitions were submitted for eight 13B40's in grade E5 and E6, two 31G40's (grade E5), and one 94B20 (grade E5). These requisitions were usually filled with 13A's in grade E3. At the end of the reporting period, the battalion had the following shortages in the grades and MOS's indicated:

<u>MOS</u>	<u>Grade</u>	<u>No. short</u>
13B40	E6	4
13B40	E5	4
31G40	E5	2
94B20	E5	1

e. The battalion submitted its first "infusion" lists, for the month of October, on 19 September 1967. To date, no notification has been received as to the disposition of these lists. However, four Lieutenants and one Captain were transferred to other Army units in this vicinity to alleviate critical shortages.

7. (U) Artillery.

a. The battalion is equipped with the 175mm gun, M107.

b. In general, this weapon has performed extremely well. Specifically, its advantages are:

(1) Extremely long range (32,500 meters).

(2) Considerably greater accuracy when firing zones 2 and 3 than it is generally given credit for, provided good registration and metro data are available.

(3) Excellent mobility over rough terrain.

c. The following characteristics have proven to be disadvantages.

1 November 1967

SUBJECT: Operational Report for Quarterly Period Ending 31 October 1967 (U)

(1) Limited traverse. Although technically capable of traversing 533 mils left and right of the center of traverse with all zones, it has been found that the firing of zone 2 at more than 300 mils, and zone 3 at more than 200 mils out of center of traverse greatly increases wear and tear on the traversing mechanism. Since the tactical situation requires coverage throughout 6400 mils, frequent relaying of guns is required (up to 14 times per day).

(2) Short tube life - only 300 rounds at zone 3 (1666 if only zones 1 and 2 are fired). The battalion has changed tubes 52 times in 75 days.

(3) Gun pads are required if a position is to be occupied for an extended length of time. Because of constant relaying and the shock of zone 3 firing, the ground beneath the gun deteriorates rapidly and introduces cant which the weapon cannot compensate for.

(4) Lack of armor protection for the crew and on-carriage components of the gun. Both are extremely susceptible to damage by shrapnel during hostile attack.

8. (U) Communications.

a. The battalion communications platoon handles the requirements for expendable signal items and PLL for the entire battalion. By exercising close control, the battalion has been able to maintain an adequate stock of all critical items.

b. Close adherence to maintenance schedules and proper supervision have resulted in an extremely low turn-in rate of communications equipment for repairs.

SECTION II. COMMANDER'S OBSERVATIONS AND RECOMMENDATIONS

Part A. (U) Observations (Lessons Learned).

1. Personnel.

Item: Publications.

Discussion: The battalion was in Vietnam for three weeks before necessary theater and local publications became available. Even then, the supply was limited both in quantity and applicability. The battalion S1 recently handcarried requisitions to Headquarters, I Field Forces at

17
1 November 1967

SUBJECT: Operational Report for Quarterly Period Ending 31 October 1967 (U)

Nha Trang only to find that most of the requested publications were not available and that it would take a minimum of 30 days to fill the requisitions. While an adequate library of USAFV regulations was ultimately obtained for the command section (mostly by borrowing from other units), there are still none at battery level.

Observation: Provisions should be made at each level of command to insure an adequate stock of publications on hand for immediate distribution to newly arrived units.

2. Operations.

a. Item: Preparation to receive unit.

Discussion: Upon arrival in-country, the battalion advance party discovered that aside from the initial decision as to the unit's operational deployment, no advance planning existed for receiving and processing the battalion. From the time the battalion arrived in Da Nang until it deployed to its tactical area of operations, no effective liaison or coordination was ever established between the Army, Navy, and Marine headquarters involved. The unit was obliged to make its own arrangements with the various individual agencies of each service for troop quartering, equipment processing, logistical and administrative support, and movement to areas of tactical deployment.

Observation: The arrival of a new unit in an established area of operations should be preceded by elementary planning and preparation for quartering, processing, and deployment. A single headquarters or agency should be given specific responsibility for establishing the necessary liaison and coordination required.

b. Item: Perimeter security.

Discussion: Under the current TO&E, a 175mm gun battalion does not have sufficient personnel to provide, over an extended period of time, the extensive perimeter security required in an active combat environment. This is especially true for a firing battery where the major elements (gun sections and FDC) are functioning 24 hours a day.

Observation: 175mm artillery battalions operating in an active combat environment should be augmented with an organic security platoon of approximately 40 men.

3. Training: None.

15
1 November 1967

SUBJECT: Operational Report for Quarterly Period Ending 31 October 1967 (U)

4. Intelligence: None.

5. Logistics.

a. Item: Gun pads.

Discussion: Because of the shock of zone 3 firing, constant shifts in direction of fire throughout 6400 miles, and frequent heavy rainfall, the ground in a 175mm firing battery position tends to deteriorate rapidly, decreasing the stability and accuracy of the weapon and increasing maintenance problems and safety hazards for the crew. Construction of a level, stable firing platform is essential if the battery is to occupy one position for any length of time. While several acceptable gun pad designs are currently in use in this area of operations, construction materials are in extremely short supply and required engineer support is difficult to obtain.

Observation: A standard "gun pad kit" of proven design and capable of being constructed by organic battery personnel should be developed and made available to heavy artillery units in Vietnam.

b. Item: Fuel cell failures on the M107.

Discussion: Since the battalion has been in-country, fuel cells on six M107's have failed. Failures occur at the welded seam adjacent to the battery storage compartment approximately three inches to the front and rear of the number three torsion bar anchor. It is believed that the failure occurs from continually firing zone 3. Failures have not occurred in rewelded seams. An Equipment Improvement Report (DA Form 2407) concerning this problem was submitted in October 1967.

Observation: Welded seams on the fuel cells of the M107 need to be reinforced to withstand the shock of continuous zone 3 firing.

c. Item: Scoop loader.

Discussion: Heavy earth-moving equipment is essential for the rapid construction of bunkers and field fortifications in an active combat zone, but is often unavailable from outside sources. The H90M scoop loader (organic only to 8" and 175mm artillery battalions) has been invaluable to this organization since its arrival in Vietnam and, on several occasions, has been utilized by other artillery units in the vicinity.

19

1 November 1967

SUBJECT: Operational Report for Quarterly Period Ending 31 October 1967 (U)

Observation: The scoop loader should be organic to all artillery units deploying to Vietnam.

6. Other.

Item: Weatherproofing of communications-electronics equipment.

Discussion: The heavy rains, high humidity, and dust common to this theater of operations require that communications-electronic equipment be protected to the maximum extent possible. Weatherproofing materials are not readily available in this area. Prior to departing CONUS, the battalion was issued the new series of radios less their protective covers.

Observation: Units should be issued protective covers for electronics-communications equipment prior to departure from CONUS. If not issued, covers should be made at CONUS installations.

Part B. Recommendations.

1. Personnel: That each level of command maintain up to date publications "packets" for immediate distribution to newly arrived units.

2. Operations: That a specific staff agency or project officer at each major level of command be charged with specific responsibility for coordination and planning in preparation for a new unit.

3. Training: None.

4. Intelligence: None.

5. Logistics: Recommend that "gun pad Kits" consisting of pre-cut and readily assembled components be developed and stocked in-country for issue to heavy artillery units.

6. Other: None.

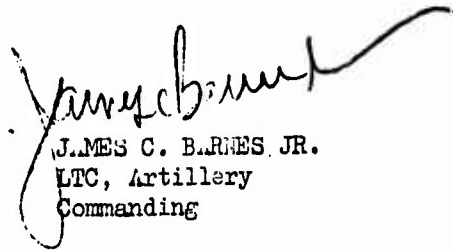
JAMES C. BARNES, JR.
LTC, Artillery
Commanding

- 4-Inclosures
- 1-Organization Chart
- Withdrawn ~~2-Average Weekly Temperature~~
- Hqs, DA 3-Average Rounds/Day by Week
- 4-Vehicle Non-availability Status

DISTRIBUTION:
CG, I FFORCEV Arty - 9

21

AVGL-00 (1 November 1967)

1st Ind

13 November 1967

SUBJECT: Operational Report for quarterly Period Ending 31 October 1967 (U)

TO: Commanding General, I Field Force Vietnam Artillery, AFO 96350

1. Forwarded herewith is the Operational Report of the 8th Battalion (175mm)(SP), 4th Artillery for the quarterly period ending 31 October 1967. This report is being forwarded to your headquarters since the battalion was assigned to I Field Force Vietnam throughout the reporting period.

2. Concur in the recommendations made in Part B of Section II of the report.

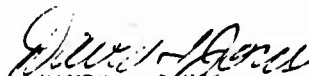

DAVID L. JONES
Colonel, Arty
Commanding

18

AVFA-AT-A (1 Nov 67)

2d Ind

SUBJECT: Operational Report for Quarterly Period Ending 31 October 1967
(8th Bn, 4th Arty) (U)

Headquarters, I Field Force Vietnam Artillery, APO 96350, 27 Nov 67

TO: Commanding General, I Field Force Vietnam, ATTN: AVFA-00-01, APO 96350

1. Concur in the observations and recommendations contained in basic communication and previous indorsement.

2. Section I, paragraph 2c (2) page 3 should read "In addition to...
~~four~~ 10-line NATO...:"

3. Reference Section II, part B, paragraph 2, page 17. A special staff officer at this headquarters, Group Headquarters and a host battalion is always appointed for coordinating, planning and receiving all new units. The 8th Battalion, 4th Artillery was diverted to I Corps Tactical Zone without this headquarters receiving notification, therefore assistance rendered was limited.

4. Reference Section II, part B, paragraph 5, page 17. Density of heavy artillery tubes does not warrant "gun pad kits" per se. Recommend an Engineer approved standard design gun pad be available to all Engineer support units for construction by Engineers on call. Current Engineer priorities list bridges over gun pads. A more flexible solution is desirable as situations demand.

FOR THE COMMANDER:



DONALD L. BURTON
Major, Artillery
Adjutant

23

CONFIDENTIAL

AVFA-GC-OT (1 Nov 67) 3d Ind
SUBJECT: Operational Report - Lessons Learned for Quarterly Period Ending
31 October 1967 RCS CSFOR-65 8th Bn, 4th Arty (U)

HEADQUARTERS, I FIELD FORCE VIETNAM, APO 96350 18 DEC 1968

TO: Commanding General, United States Army Vietnam, ATTN: AVFGC-DJT,
APO 96375

(C) This headquarters has reviewed the 8th Battalion, 4th Artillery
Operational Report - Lessons Learned for the quarterly period ending 31
October 1967 and concurs with the observations and recommendations of the
basic document and previous indorsements except as follows:

Reference Section II, Parts I and II, Commander's Observations
and Recommendations:

a. Paragraph 2b (page 15). The additional infantry MOS
personnel required to man such a force could be employed more effectively
in infantry units within the command. The 175mm Gun Batteries are not
deployed unless adequate tactical security is available.

b. Paragraph 5a (page 16), paragraph 5 (page 17) and
paragraph 4, 2d Indorsement (page 19). This headquarters has prepared
plans for a standard design for gun pads within II CTZ.

FOR THE COMMANDER:

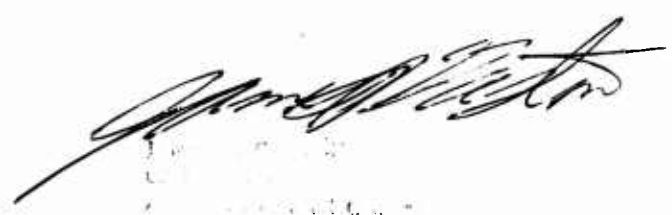

CONFIDENTIAL

DOWNGRADED AT 3 YEAR INTERVALS;
DECLASSIFIED AFTER 12 YEARS.
DOD DIR 5200.10

CONFIDENTIAL

14

AVHGC-DST (1 Nov 67)

4th Ind (C)

SUBJECT: Operational Report for Quarterly Period Ending 31 October 1967 (U)

HEADQUARTERS, UNITED STATES ARMY VLETNAM, APO San Francisco 96375 30 JAN 1968

TO: Commander in Chief, United States Army, Pacific, ATTN: GPOP-DT,
APO 96558

1. (U) This headquarters has reviewed the Operational Report-Lessons Learned for the period ending 31 October 1967 from Headquarters, 8th Battalion (175MM) (SP), 4th Artillery (D3HA) as indorsed.

2. (C) Pertinent comments follow:

a. Reference item concerning publications, page 14, paragraph 1; and page 17, paragraph 1: Concur. A weekly review is now being conducted by HQ USARV to determine units requiring in-country publications prior to deployment. Control procedures have been strengthened to insure units receive publications prior to arriving in-country. Resupply of these directives can be obtained by submitting a DA Form 17 to this headquarters, ATTN: AVHAG-P, or Headquarters, MACV, ATTN: MACAG.

b. Reference item concerning preparation to receive unit, page 15, paragraph A2a: Concur. USARV Regulation 220-10 and USARV Letter, subject: "Verification of Units Programmed for RVN", outline sponsorship responsibilities and designate a sponsor for each incoming unit. I FFORCEV was originally designated sponsor for this unit and was preparing for its reception. While the unit was at sea, COMUSMACV made the decision to divert it to I CTZ, and designated CG, III MAF as sponsor. The problems experienced were apparently caused by misunderstanding on the part of CG, III MAF concerning sponsorship requirements as well as the late date at which the diversion was directed. With the arrival of the 108th FA Group in I CTZ in October 1967, a US Army headquarters became available in this area to act as sponsor for future deployments.

c. Reference item concerning perimeter security, page 15, paragraph 2b: Concur with 3d Indorsement.

d. Reference item concerning gun pads, page 16, paragraph 5a; and page 17, paragraph 5: Concur. The priority of material for tactical operations will be established by the senior tactical commander.

3. (U) A copy of this indorsement will be furnished to the reporting unit through channels.

FOR THE COMMANDER:

*Downgraded at 3 year Intervals
Declassified after 12 years
DOD DIR 5200.10*

C. S. NAKATSUKASA
C. S. NAKATSUKASA
Captain, AGC
Assistant Adjutant General

cy furn:
HQ, 8th Bn (175MM)(SP), 4th Arty
GROUP 14FFORCEV

CONFIDENTIAL

25-

GPOP-DT(1 Nov 67) (U) 5th Ind
SUBJECT: Operational Report for the Quarterly Period Ending 31 October
1967 from HQ, 8th Bn (175mm)(SP) 4th Arty (UIC: WD3HAA)
(RCS CSFOR-65)

HQ, US ARMY, PACIFIC, APO San Francisco 96558 17 FEB 1968

TO: Assistant Chief of Staff for Force Development, Department of the
Army, Washington, D. C. 20310

This headquarters has evaluated subject report and forwarding
indorsements and concurs in the report as indorsed.

FOR THE COMMANDER IN CHIEF:

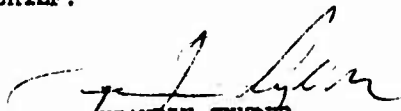
HEAVRIN SNYDER
CPT, AGC
Asst AG

4 Incl
nc

27

ORGANIZATION CHART

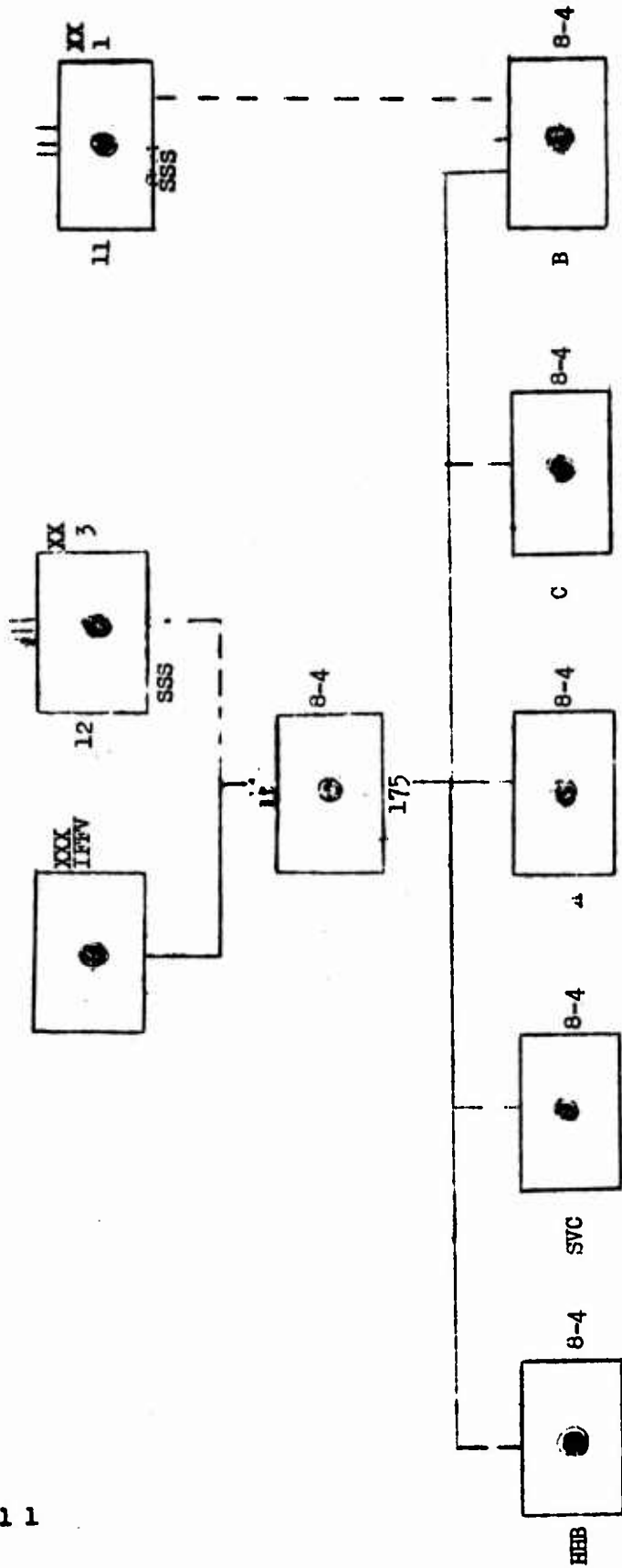

Incl 1

— COMMAND
 - - - OPERATIONAL CONTROL ONLY

AVERAGE ROUNDS PER DAY BY WEEK

28

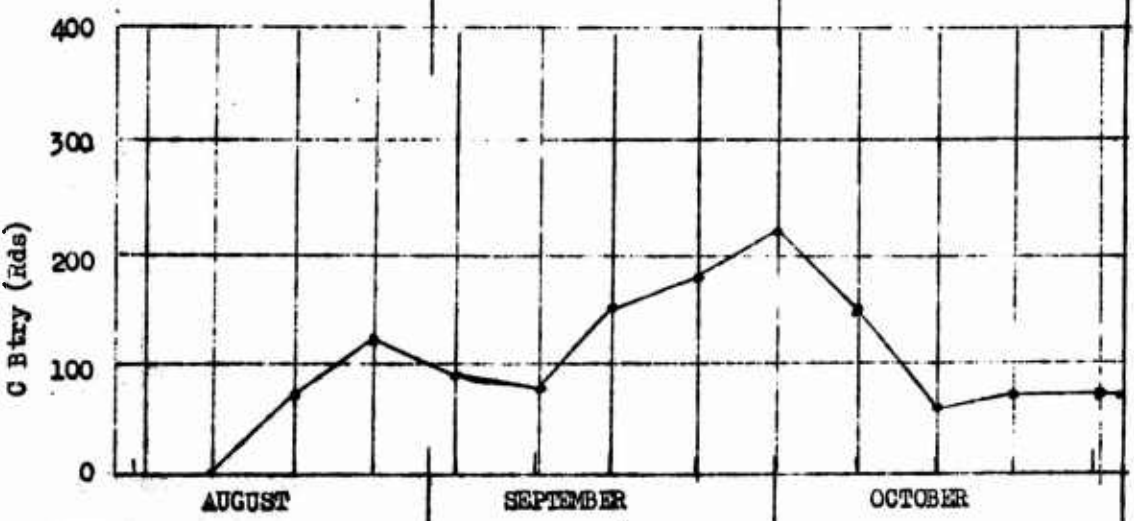
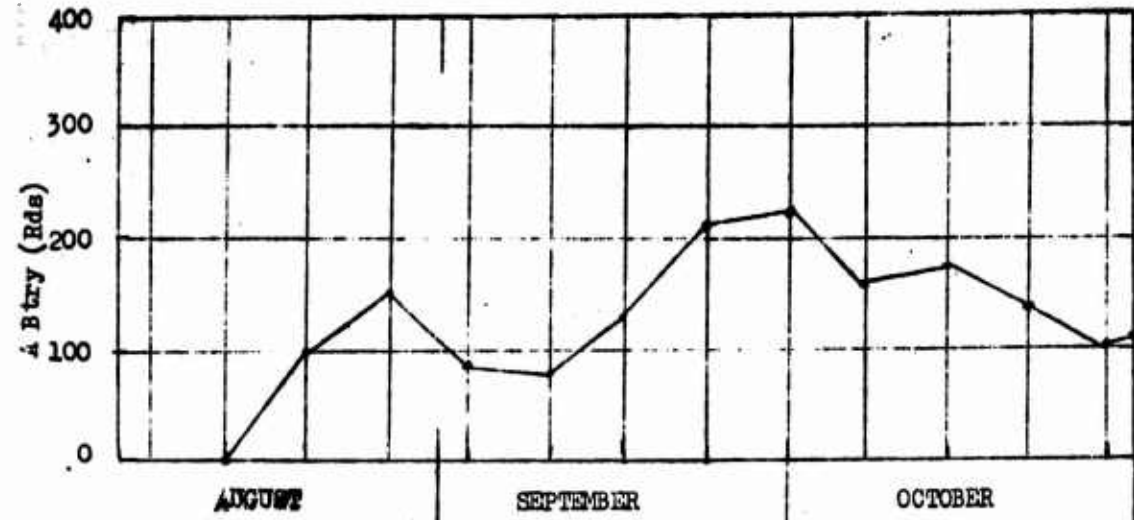

Incl 3

24

29

VEHICLE NON-AVAILABILITY
(Deadline Rate)

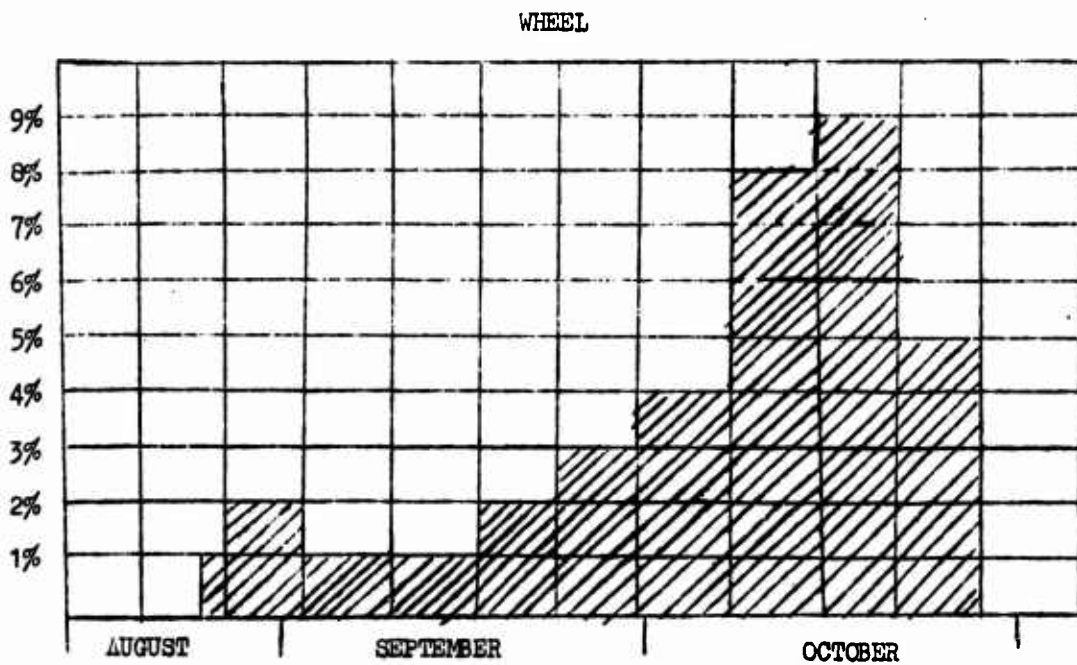
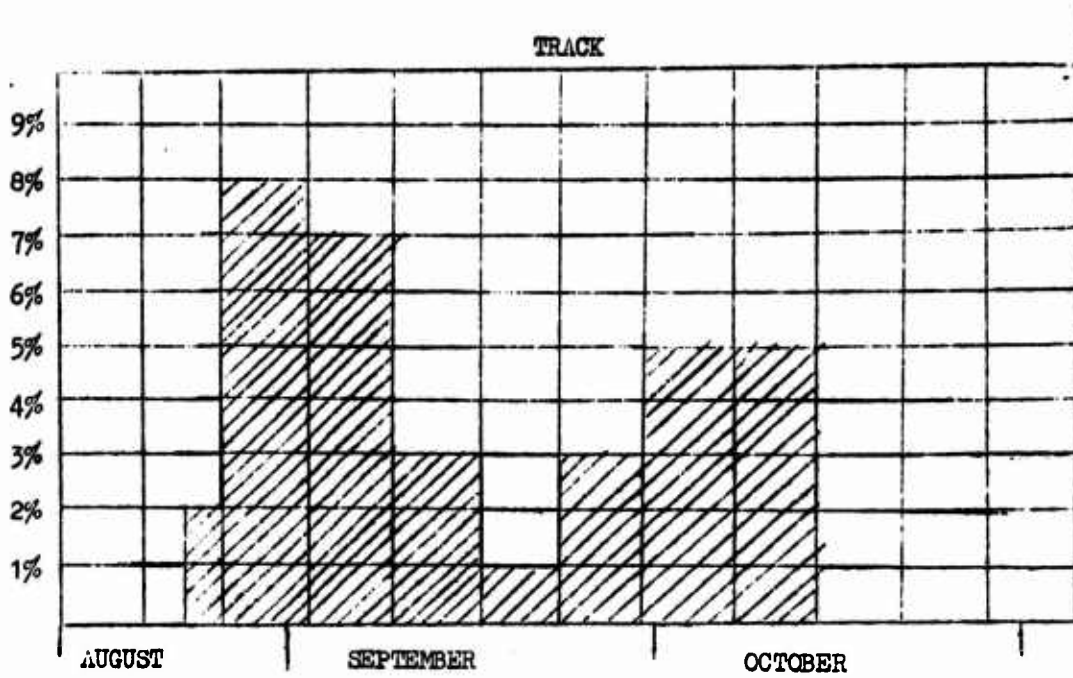

DOCUMENT CONTROL DATA - R & D

30

(Security classification of title, body of abstract and indexing annotation must be entered when the overall report is classified)

1. ORIGINATING ACTIVITY (Corporate author) OACSFOR, DA, Washington, D.C. 20310	2a. REPORT SECURITY CLASSIFICATION Confidential
	2b. GROUP 4

3. REPORT TITLE
Operational Report - Lessons Learned, Headquarters, 8th Battalion, 4th Artillery

4. DESCRIPTIVE NOTES (Type of report and inclusive dates)
Experiences of unit engaged in counterinsurgency operations, 1 Aug - 31 Oct 1967

5. AUTHOR(S) (First name, middle initial, last name)
CO, 8th Battalion, 4th Artillery

6. REPORT DATE 1 November 1967	7a. TOTAL NO. OF PAGES 26	7b. NO. OF REFS
--	-------------------------------------	-----------------

8a. CONTRACT OR GRANT NO. 8. PROJECT NO. N/A c. d.	9a. ORIGINATOR'S REPORT NUMBER(S) 674201
	9b. OTHER REPORT NO(S) (Any other numbers that may be assigned this report)

10. DISTRIBUTION STATEMENT

11. SUPPLEMENTARY NOTES N/A	12. SPONSORING MILITARY ACTIVITY OACSFOR, DA, Washington, D.C. 20310
---------------------------------------	--

13. ABSTRACT

26