

UNCLASSIFIED

AD NUMBER

AD317119

CLASSIFICATION CHANGES

TO: unclassified

FROM: confidential

LIMITATION CHANGES

TO:  
Approved for public release, distribution unlimited

FROM:  
Distribution authorized to DoD only;  
Administrative/Operational Use; APR 1960.  
Other requests shall be referred to US  
Army Development and Proof Services, Attn:  
Infantry and Aircraft Weapons Division,  
Aberdeen Proving Ground, MD 21010.  
Pre-dates formal DoD distribution

AUTHORITY

CSL d/a ltr 16 Mar 1981; CSL d/a ltr 16  
Mar 1981

THIS PAGE IS UNCLASSIFIED

THIS REPORT HAS BEEN DELIMITED  
AND CLEARED FOR PUBLIC RELEASE  
UNDER DOD DIRECTIVE 5200.20 AND  
NO RESTRICTIONS ARE IMPOSED UPON  
ITS USE AND DISCLOSURE.

DISTRIBUTION STATEMENT A

APPROVED FOR PUBLIC RELEASE;  
DISTRIBUTION UNLIMITED.

CONFIDENTIAL

AD 317 / 19

CLASSIFICATION CHANGED  
TO: CONFIDENTIAL  
FROM: UNCLASSIFIED  
AUTHORITY:

CSL, DA  
17r, 16, MAR 81



CONFIDENTIAL



**AD**

**3 1 7 1 1 9**

Reproduced by

**Armed Services Technical Information Agency**

**ARLINGTON HALL STATION; ARLINGTON 12 VIRGINIA**

**NOTICE: WHEN GOVERNMENT OR OTHER DRAWINGS, SPECIFICATIONS OR OTHER DATA ARE USED FOR ANY PURPOSE OTHER THAN IN CONNECTION WITH A DEFINITELY RELATED GOVERNMENT PROCUREMENT OPERATION, THE U. S. GOVERNMENT THEREBY INCURS NO RESPONSIBILITY, NOR ANY OBLIGATION WHATSOEVER; AND THE FACT THAT THE GOVERNMENT MAY HAVE FORMULATED, FURNISHED, OR IN ANY WAY SUPPLIED THE SAID DRAWINGS, SPECIFICATIONS, OR OTHER DATA IS NOT TO BE REGARDED BY IMPLICATION OR OTHERWISE AS IN ANY MANNER LICENSING THE HOLDER OR ANY OTHER PERSON OR CORPORATION, OR CONVEYING ANY RIGHTS OR PERMISSION TO MANUFACTURE, USE OR SELL ANY PATENTED INVENTION THAT MAY IN ANY WAY BE RELATED THERETO.**

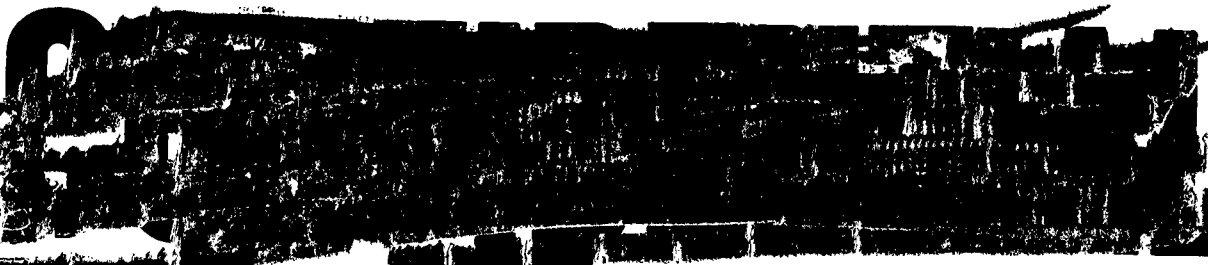

**Best  
Available  
Copy**

# Development and Proof Services

REFERENCE COPY

REPORT NO. DPS/TW-201/3

INFANTRY AND AIRCRAFT WEAPONS DIVISION

10

REPORT ON

FRAGMENTATION OF SHELL, HE, 115-MM, XM378

COMPOSITION B LOADED (U)

Third Report on Ordnance Project No. TW-201

(D. A. Project No. 517-07-021)

J. T. DEMPSEY

APRIL 1960

AD NO. 317-119  
ASTIA FILE COPY

**FILE COPY**  
Return to  
**ASTIA**  
ARLINGTON HALL STATION  
ARLINGTON 12, VIRGINIA  
NOX

*Aberdeen Proving Ground  
Maryland*

**CONFIDENTIAL**

# CONFIDENTIAL

DEVELOPMENT AND PROOF SERVICES  
ABERDEEN PROVING GROUND  
MARYLAND

AUTHORITY: ORDBB-TE3 470

JTDempsey/ma/41155

FRAGMENTATION OF SHELL, HE, 115-MM, XM378

COMPOSITION B LOADED (U)

Third Report on Ordnance Project No. TW-201

Dates of Test: November 1959 to March 1960

## ABSTRACT (C)

The Feltman Research and Engineering Laboratories developed a pearlitic malleable iron shell, the XM378, 115-mm, Comp B loaded. This shell was developed to be used with the XM71 launcher system and is expected to be an improvement over present artillery shell.

Three Shell, HE, 115-mm, XM378 were fragmented to evaluate fragmentation characteristics. The test results indicate that the shell will produce 32,115 fragments, with an average fragment weight of 5.11 grains, and a mean initial velocity of 4279 feet per second. Forty-four per cent of the fragments were in the weight group 0 to 1 grain.

It is recommended that an effort be made to reduce the number of small (0 to 1 grain), fragments produced by this shell. Further development is recommended in order to achieve this purpose.

# CONFIDENTIAL

CONTENTS (U)

	<u>PAGE</u>
INTRODUCTION . . . . .	3
DESCRIPTION OF MATERIEL . . . . .	3
DETAILS OF TEST . . . . .	3
Facilities . . . . .	3
Procedure . . . . .	7
Analysis of Data . . . . .	28
CONCLUSIONS . . . . .	30
RECOMMENDATIONS . . . . .	31
APPENDIX A: CORRESPONDENCE . . . . .	A-1
APPENDIX B: INDIVIDUAL FRAGMENT WEIGHTS . . . . .	B-1
APPENDIX C: ANALYTICAL LABORATORY REPORT . . . . .	C-1
APPENDIX D: DISTRIBUTION . . . . .	D-1

ANNEX

EDVAC CODES

AMMUNITION DATA CARD NO. 91666

(The Annex is on file in the Technical Library, APG, for reference purposes. Copies of the Annex may be furnished to recipients of this report upon request.)



# CONFIDENTIAL

## 1. (C) INTRODUCTION

A requirement exists for a self-propelled artillery weapon system to provide direct support to infantry, airborne and armored divisions. As present weapons approach their optimum in development, it becomes necessary to develop a new weapon to obtain improvement in artillery tactics. The rocket offers a definite promise in supplying the required advantage needed by field artillery in providing direct support.

The 115-mm, XM378 shell which has been developed at Picatinny Arsenal to be used with the XM71 launcher system is expected to be an improvement over present artillery shell. The body of this shell is pearlitic malleable iron which weighs approximately 22 pounds.

## 2. (C) DESCRIPTION OF MATERIEL

The following materiel was used in this test:

Three Shell, 115-mm, XM378, Composition B loaded, Lot No. PA-E-29784. This shell had a two-piece body made of pearlitic malleable iron brazed together just forward of the rotating band. Both pieces weighed approximately 22 pounds. The shell was modified to the extent that the large stud on the base of the shell, as shown on drawing No. DXP-107800, Appendix A, was removed, and the base tapped for a brass plug which was screwed in flush with the base of the shell (see Correspondence, Appendix A). The composition B filler had an approximate weight of 10.4 pounds.

Three Fuzes, PD, M51A5, modified for static firing. No lot number.

Three blasting caps, electric, type II.

## 3. DETAILS OF TEST

### 3.1 (U) Facilities

The facilities used for the fragmentation test consisted of a rectangular arena arranged around the ammunition. One half of the arena contained 180° of recovery surface and the other half 180° of velocity targets.

The fragment-recovery area consisted of a wooden structure which contained 4- by 8-foot by 1/2-inch sheets of composition wallboard placed upright to a depth of 4 feet. The wallboard was gridded into 10° zones, annular zones from 0° to 45° and 135° to 180°, vertical zones from 45° to 135° (zone 1, 0° to 5°; zone 2, 5° to 15°; zone 3, 15° to 25°; etc.). In addition, two boxes, 4 by 8 by 3 feet in depth, were filled with composition wallboard and placed outside of the test arena. One was placed at the nose end or 0°, and the other at the base end or 180°, both 35 feet from the center of the test setup. These recovery boxes were used to obtain additional information from both the nose and base fragments. This was accomplished by subtending the arc of both zone 1 on the nose box and zone 19 on the base box, which made it possible to recover a better sample of fragments that penetrated the wallboard in these two zones.

Figures 1, 2, and 3 show the plan view and pictures of the setup.

3  
**CONFIDENTIAL**

PLAN VIEW OF TEST SETUP

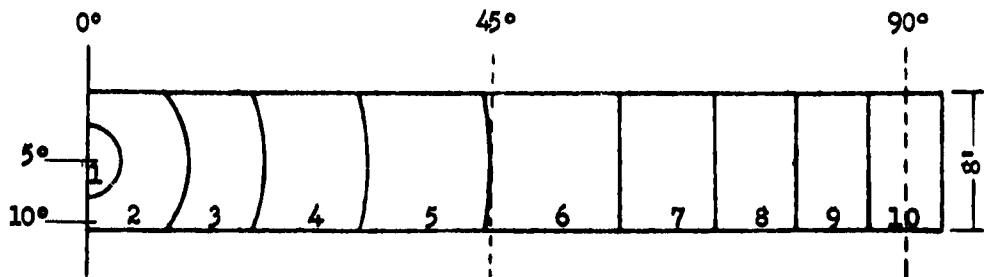
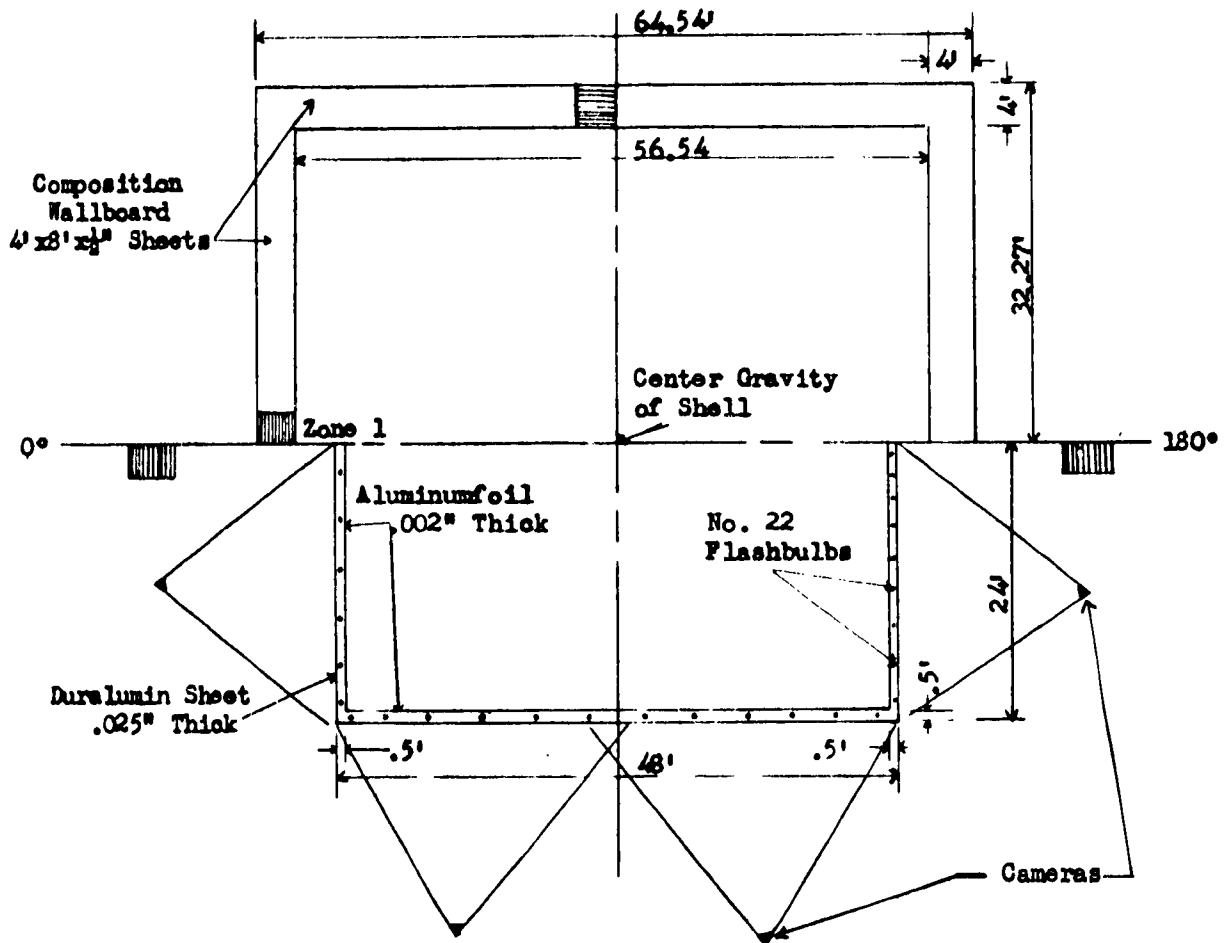

ZONING OF RECOVERY AND VELOCITY TARGETS

Figure 1.

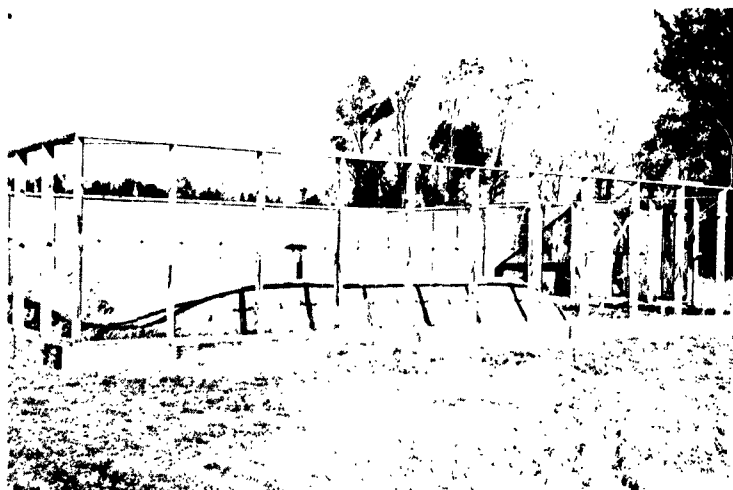

Figure 2 - 591382: General View of Test Setup.

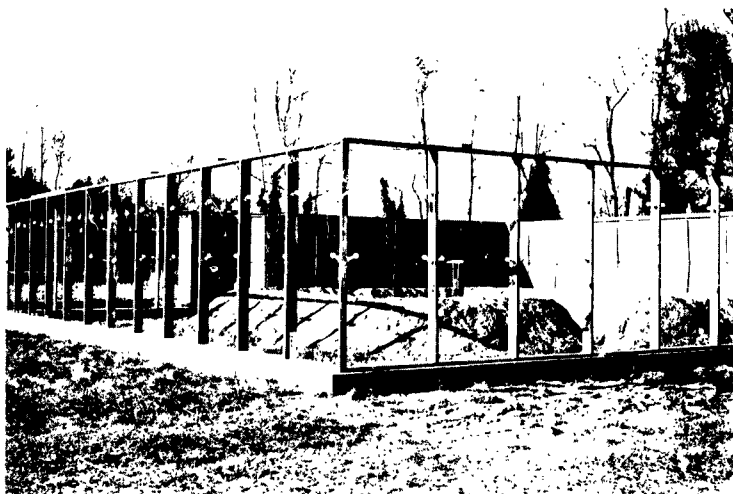

Figure 3 - 591382: General View of Test Setup Showing Zoning for Fragment Recovery.

The fragment-velocity setup consisted of two  $130^\circ$ , rectangular, vertical walls constructed 8 feet high, and set 6 inches apart with vertical supports every 4 feet. The outer wall contained 34 sheets of duralumin, each 4 by 8 feet by 0.025 inch thick with the outside surface painted black, and gridded into 2-foot horizontal sections and 19 zones vertically which corresponded with the zones gridded on the wallboard. Figures 4 and 5 show velocity-target gridding. The perpendicular distance from the center of the ammunition to the duralumin at  $0^\circ$ ,  $90^\circ$ , and  $180^\circ$  was 24 feet. The inner wall was composed

of 0.002-inch aluminum foil which was used as a reflector for the number 22 flashbulbs placed at intervals between the walls (nine bulbs for each 4-foot by 3-foot target area). These bulbs were timed to be at their maximum brilliance when the fragments perforated the velocity targets. Flashbulbs were also placed around the outside of the arena, and positioned to illuminate the velocity targets so a record of the gridding could be visible on the high-speed film. The flashbulb function was synchronized by means of an electronic sequence timer which assured that the outside bulbs be out before the fragments struck the velocity targets.

Four high-speed motion-picture cameras operating at a speed of approximately 10,000 frames per second and equipped with frequency standards and electronic timing devices were positioned around the targets to photograph both the detonation of the shell and the impact of fragments on the velocity targets. To insure positive identification of detonation, the cameras were focused through a cylinder of 1/16-inch wall and 1/2 inches in diameter which was placed through holes cut in the aluminum foil. Views of the flashbulb reflectors and cardboard cylinders in position are shown in Figures 4 and 5.



Figure 4 - 59T3823: General View of Velocity Targets Showing Gridding.

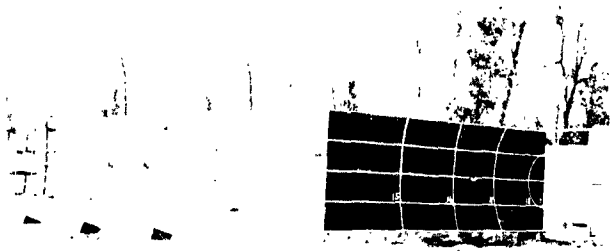

Figure 5 - 59T3827: General View of Velocity Targets Showing Gridding.

## CONFIDENTIAL

OPM 80-16, Volume IV, contains further details of flashbulb installation and velocity measurement technique.

A ricochet stop was provided for both the recovery area and the velocity targets to prevent fragments that struck the ground from ricocheting into the recovery or velocity panels. OPM 70-90, Volume I, contains other details on fragmentation procedure.

### 3.2 Procedure

(U) The shell and component parts were weighed and the recorded weights are shown in Table I.

Table I (C). Shell, 115-mm, XM378, Lot No. PA-E-29784

Rd No.	Shell No.	Weight Empty, lb	Weight Explosive Comp B, lb	Weight Loaded, lb	Weight Fuze M51A1 Modified, lb	Weight As Fired, lb
1	1	22.16	10.39	32.55	1.51	34.06
2	2	22.04	10.41	32.45	1.51	33.96
3	5	21.63	10.52	32.15	1.51	33.66

(U) Each shell was assembled with Fuze, PD, M51A5, modified for static firing, and placed individually on a wooden pedestal at the center of the setup. The pedestal was constructed so that the horizontal centerline of the shell corresponded with the horizontal centerline of both the recovery boxes and velocity targets. The nose of each shell pointed toward the edges of the composition wallboard and velocity targets at zero degrees. The shell was detonated by using a blasting cap, electric, type II initiated by a 110-volt power source.

(U) After detonation of each shell, a plot of the position of each hit in the duralumin targets was recorded on graph paper. This was used to correlate with the image of hits obtained on the high-speed film. Then, knowing the distance from the shell to the target, and the fragment travel time (which is obtained from the high-speed film) the individual fragment velocity was computed.

(U) The fragments that impacted the wallboard were located by using an electronic metal detector. After being located the fragments were identified and recovered by zones, cleaned, weighed, and tabulated. The individual fragment weights are found in Appendix B.

(U) A sample of the recovered fragments, identified by zone and segregated into weight groups, is shown in Figures 6 and 7.

Tables II, III, and IV show the distribution of fragments by number and weight group.

**CONFIDENTIAL**



Figure 6 - 1315-81-2T59: Recovered Fragments of Shell, 115-mm, XM378  
Composition B Loaded, Zones 1 to 11.

Best Available Copy

**CONFIDENTIAL**



Figure 7 - 1315-81-1159: Recovered Fragments of Shell, 115-mm, XM378  
Composition B Loaded, Zones 12 to 19.

**CONFIDENTIAL**

**CONFIDENTIAL**

TABLE II (C)  
**FRAGMENT RECOVERY**

TYPE: 115-mm X-370		DATE FIRED: 4 November 1959		ROUND NO.: 1																		
FILLER: Composition B		DISTRIBUTION OF FRAGMENTS BY NUMBER AND WEIGHT																				
WEIGHT INTERVALS IN GRAIN	ZONE 1		ZONE 2		ZONE 3		ZONE 4		ZONE 5		ZONE 6		ZONE 7		ZONE 8		ZONE 9		ZONE 10		ZONE 11	
	NO.	WT.	NO.	WT.	NO.	WT.	NO.	WT.	NO.	WT.	NO.	WT.	NO.	WT.	NO.	WT.	NO.	WT.	NO.	WT.	NO.	WT.
0-1	1		2		N				2		4		2		17		49		152		109	
	WT.	0.34	0.92		O				0.02		2.32		1.30		3.29		16.09		56.20		85.35	
1-2	3		1						2		1				3		15		30		83	
	WT.	4.45	1.84						3.18		1.72				5.00		27.88		55.61		118.62	
2-5	3				E				3		3		4		5		19		63		113	
	WT.	5.95			C				11.43		1.89		13.36		16.58		65.03		158.82		379.54	
5-8	2				O				1						1		10		20		52	
	WT.	11.30			V				5.35						5.00		65.30		124.24		330.09	
8-10					E		1										3		17		25	
	WT.				R		8.39										26.82		150.08		222.90	
10-15	2				Y												3		16		37	
	WT.	26.27									22.20						37.30		109.53		457.05	
15-20													1						4		25	
	WT.												15.80						65.51		434.22	
20-25			2														1		2		11	
	WT.		45.05														20.70		61.64		249.72	
25-35									22.58								1		1		15	
	WT.																31.86		28.80		453.53	
35-50																					6	
	WT.																				246.40	
50-60																						5
	WT.																					283.74
60-70																						2
	WT.																					130.08
70-80																						1
	WT.																					71.20
80-90									1													1
	WT.								86.22													88.80
90-100											1											2
	WT.										94.14											183.80

**CONFIDENTIAL**



**CONFIDENTIAL**

**FRAGMENT RECOVERY**

TYPE: 115-mm XM376		DATE FIRED: 4 November 1959		ROUND NO.: 1								
FILLER: Composition B		DISTRIBUTION OF FRAGMENTS BY NUMBER AND WEIGHT										
WEIGHT INTERVALS IN GRAIN		ZONE 1	ZONE 2	ZONE 3	ZONE 4	ZONE 5	ZONE 6	ZONE 7	ZONE 8	ZONE 9	ZONE 10	ZONE 11
		NO. WT.	NO. WT.	NO. WT.	NO. WT.	NO. WT.	NO. WT.	NO. WT.	NO. WT.	NO. WT.	NO. WT.	NO. WT.
100-125		1 105.00										2 213.00
125-150												
150-200												
200-250												
250-300												
300-400												
400-500												
500-750												
750-1000		1 945.00										
1000 & over												
TOTAL		13 1102.39	5 47.88	- -	1 8.39	10 129.65	11 130.17	8 30.46	26 29.87	105 289.09	315 956.23	686 3948.63

**CONFIDENTIAL**

CONFIDENTIAL

FRAGMENT RECOVERY

TYPE: 115-mm XM378		DATE FIRED: 4 November 1999		ROUND NO.: 1													
FILLER: Composition B		DISTRIBUTION OF FRAGMENTS BY NUMBER AND WEIGHT															
WEIGHT INTERVALS IN GRAIN	ZONE 12		ZONE 13		ZONE 14		ZONE 15		ZONE 16		ZONE 17		ZONE 18		ZONE 19		TOTAL
	NO.	WT.	NO.	WT.	NO.	WT.	NO.	WT.	NO.	WT.	NO.	WT.	NO.	WT.	NO.	WT.	
0-1	36	12.97	22	8.06	16	3.75	11	6.86	2	0.80	84	25.93	70	24.36	102	22.35	887
1-2	12	17.84	10	14.15	2	3.66	2	2.64	1	1.85	23	34.76	44	65.49	6	8.95	271.87
2-5	11	36.84	23	67.88	5	16.50	5	16.62	1	3.44	13	37.70	34	105.05	10	31.11	371.84
5-8	2	10.82	14	91.39	1	6.67					6	33.15	7	43.17	7	43.02	315
8-10	2	17.11	3	27.97	1	8.14					4	35.06	5	46.15	2	17.11	1018.25
10-15	4	46.19	6	67.70							4	44.91	6	72.52	1	12.50	123
15-20	1	15.45	1	15.45			1	19.05			2	37.72	3	51.88	2	32.95	750.27
20-25													3	62.84			63
25-35			3	87.63	1	25.27									4	462.53	560.63
35-50															25	750.29	81
50-60															2	84.02	986.21
60-70															5	283.74	39
70-80															1	193.88	672.78
80-90															1	147.40	21
90-100															1	258.08	462.53
															4	375.12	8

CONFIDENTIAL

CONFIDENTIAL

FRAGMENT RECOVERY

TYPE: 11.5-mm M378		DATE FIRED: 4 November 1959		ROUND NO.: 1															
FILLER: Composition B		DISTRIBUTION OF FRAGMENTS BY NUMBER AND WEIGHT																	
WEIGHT INTERVALS IN GRAIN		ZONE 12	ZONE 13	ZONE 14	ZONE 15	ZONE 16	ZONE 17	ZONE 18	ZONE 19	TOTAL									
		NO.	WT.	NO.	WT.	NO.	WT.	NO.	WT.		NO.	WT.							
100-125										3	316.00								
125-150																			
150-200																			
200-250																			
250-300																			
300-400																			
400-500																			
500-750																			
750-1000										1	945.00								
1000 & Over																			
TOTAL		67	141.77	82	380.31	26	63.99	19	45.17	4	6.09	136	289.29	180	471.48	140	695.45	1834	8726.31

CONFIDENTIAL

CONFIDENTIAL

FRAGMENT RECOVERY

TYPE: 115-mm XM378		DATE FIRED: 4 November 1959		ROUND NO.: 1							
FILLER: Composition B											
WEIGHT INTERVALS IN GRAIN	DISTRIBUTION OF FRAGMENTS BY NUMBER AND WEIGHT										GRAND TOTAL ALL FRAGS
	NO.	WT.	ZONE 1N	ZONE 2N	TOTAL	ZONE 19B	ZONE 18B	TOTAL			
0-1	NO. 1	WT. 0.75	ZONE 1N 0.99	ZONE 2N 1	TOTAL 2	ZONE 19B 3	ZONE 18B 16	TOTAL 19			903
1-2	NO. 2	WT. 2.78	ZONE 1N 2	ZONE 2N 2	TOTAL 4	ZONE 19B 1	ZONE 18B 8	TOTAL 9			275.46
2-5	NO. 7	WT. 26.28	ZONE 1N 7	ZONE 2N 7	TOTAL 14	ZONE 19B 1	ZONE 18B 12.43	TOTAL 13.93			262
5-8	NO. 1	WT. 12.4	ZONE 1N 1	ZONE 2N 1	TOTAL 2	ZONE 19B 2.09	ZONE 18B 15.61	TOTAL 17.90			366.55
8-10	NO. 1	WT. 5.92	ZONE 1N 1	ZONE 2N 1	TOTAL 2	ZONE 19B 1	ZONE 18B 5.92	TOTAL 6.92			326
10-15	NO. 2	WT. 26.64	ZONE 1N 2	ZONE 2N 2	TOTAL 4	ZONE 19B 2	ZONE 18B 2	TOTAL 4			1062.43
15-20	NO. 1	WT. 18.16	ZONE 1N 1	ZONE 2N 1	TOTAL 2	ZONE 19B 21.59	ZONE 18B 2	TOTAL 23.59			124
20-25	NO. 1	WT. 18.16	ZONE 1N 1	ZONE 2N 1	TOTAL 2	ZONE 19B 1	ZONE 18B 18.16	TOTAL 19.16			786.19
25-35	NO. 1	WT. 18.16	ZONE 1N 1	ZONE 2N 1	TOTAL 2	ZONE 19B 1	ZONE 18B 18.16	TOTAL 19.16			63
35-50	NO. 1	WT. 18.16	ZONE 1N 1	ZONE 2N 1	TOTAL 2	ZONE 19B 1	ZONE 18B 18.16	TOTAL 19.16			560.63
50-60	NO. 1	WT. 18.16	ZONE 1N 1	ZONE 2N 1	TOTAL 2	ZONE 19B 1	ZONE 18B 18.16	TOTAL 19.16			65
60-70	NO. 1	WT. 18.16	ZONE 1N 1	ZONE 2N 1	TOTAL 2	ZONE 19B 1	ZONE 18B 18.16	TOTAL 19.16			1034.44
70-80	NO. 1	WT. 18.16	ZONE 1N 1	ZONE 2N 1	TOTAL 2	ZONE 19B 1	ZONE 18B 18.16	TOTAL 19.16			40
80-90	NO. 1	WT. 18.16	ZONE 1N 1	ZONE 2N 1	TOTAL 2	ZONE 19B 1	ZONE 18B 18.16	TOTAL 19.16			690.94
90-100	NO. 1	WT. 18.16	ZONE 1N 1	ZONE 2N 1	TOTAL 2	ZONE 19B 1	ZONE 18B 18.16	TOTAL 19.16			21
											462.53
											25
											750.29
											6
											330.42
											5
											283.74
											3
											193.88
											2
											147.40
											3
											258.08
											4
											375.12

CONFIDENTIAL

**CONFIDENTIAL**

**FRAGMENT RECOVERY**

TYPE: 115-mm XM378		DATE FIRED: 4 November 1959		ROUND NO.: 1										
FILLER: Composition B		DISTRIBUTION OF FRAGMENTS BY NUMBER AND WEIGHT												
WEIGHT INTERVALS IN GRAIN	ZONE 1N		ZONE 2N		TOTAL		ZONE 19B		ZONE 30		TOTAL		GRAND TOTAL ALL FRAGS	
	NO.	WT.	NO.	WT.	NO.	WT.	NO.	WT.	NO.	WT.	NO.	WT.	NO.	WT.
100-125														
125-150														
150-200														
200-250														
250-300														
300-400														
400-500														
500-750														
750-1000														
1000 & Over														
						1	5507.00							1
						1	5507.00							1
														5507.00
TOTAL						13	74.61	2	5507.99	15	5582.60			
						7	26.18	30	39.03	37	65.21			
														1886
														14374.1F

**CONFIDENTIAL**

CONFIDENTIAL

Table III (C)  
FRAGMENT RECOVERY

TYPE: 115-mm XM378		DATE FIRED: 12 November 1959											ROUND NO.: 2	
FILLER: Composition B		DISTRIBUTION OF FRAGMENTS BY NUMBER AND WEIGHT												
WEIGHT INTERVALS IN GRAIN		ZONE 1	ZONE 2	ZONE 3	ZONE 4	ZONE 5	ZONE 6	ZONE 7	ZONE 8	ZONE 9	ZONE 10	ZONE 11		
		NO.	WT.	NO.	WT.	NO.	WT.	NO.	WT.	NO.	WT.	NO.	WT.	NO.
0-1		27	17	17	4	9	6	13	17	41	78	159		
		6.59	5.60	0	0.66	2.54	1.71	4.23	4.13	12.59	20.7	53.14		
1-2		4	6			3		2	6	17	30	52		
		4.70	8.29	R		4.42		3.14	7.83	24.01	44.45	66.25		
2-5		2	2	e		1	3		6	13	41	90		
		9.71	5.15	c		2.78	8.32		18.95	46.95	133.94	295.62		
5-8			2	o				2		4	19	44		
			13.75	v				11.50		26.30	120.70	282.86		
8-10			1	e				1		2	12	25		
			8.09	r				9.00		19.10	103.53	225.22		
10-15		3		y						2	15	34		
		35.13					24.29			25.98	191.67	419.04		
15-20			1							3	9	28		
			17.86							49.50	130.15	469.82		
20-25		2	1								4	12		
		43.00	22.82								88.36	277.24		
25-35		1								1	5	16		
		33.20					25.36			28.12	143.62	532.13		
35-50											2	10		
											77.66	392.66		
50-60			1									5		
			51.20									267.03		
60-70			1									3		
			68.20									191.66		
70-80												3		
												218.10		
80-90														
90-100														
							96.80							

CONFIDENTIAL

**CONFIDENTIAL**

**FRAGMENT RECOVERY**

TYPE: 115-mm XM378		DATE FIRED: 12 November 1959										ROUND NO.: 2		
FILLER: Composition B		DISTRIBUTION OF FRAGMENTS BY NUMBER AND WEIGHT												
WEIGHT INTERVALS IN GRAIN		ZONE	ZONE	ZONE	ZONE	ZONE	ZONE	ZONE	ZONE	ZONE	ZONE	ZONE	ZONE	ZONE
		1	2	3	4	5	6	7	8	9	10	11		
100-125	NO.		1	N			1							
	WT.		101.00	o			111.00							
125-150	NO.			R										
	WT.			e										
150-200	NO.	1	1	c		1								
	WT.	180.00	169.00	c		176.00								
200-250	NO.			o										
	WT.			v										
250-300	NO.			e										
	WT.			r										
300-400	NO.			y										
	WT.													
400-500	NO.													
	WT.													
500-750	NO.		1											
	WT.		703.00											
750-1000	NO.													
	WT.													
1000 and Over	NO.	1												
	WT.	5135.00												
	NO.													
	WT.													
	NO.													
	WT.													
	NO.													
	WT.													
	NO.													
	WT.													
Total	NO.	41	35	-	4	14	14	18	29	83	214	489		
	WT.	5497.63	1173.96	-	0.66	185.74	267.48	27.87	30.91	234.55	1062.98	3718.05		

**CONFIDENTIAL**

CONFIDENTIAL

FRAGMENT RECOVERY

TYPE: 115-mm XM378		DATE FIRED: 12 November 1959		ROUND NO.: 2															
FILLER: Composition B		DISTRIBUTION OF FRAGMENTS BY NUMBER AND WEIGHT																	
WEIGHT INTERVALS IN GRAIN	ZONE 12		ZONE 13		ZONE 14		ZONE 15		ZONE 16		ZONE 17		ZONE 18		ZONE 19		TOTAL		
	NO.	WT.	NO.	WT.	NO.	WT.	NO.	WT.	NO.	WT.	NO.	WT.	NO.	WT.	NO.	WT.	NO.	WT.	
0-1	12	6.93	27	11.28	15	6.99	1	0.72	7	3.86	80	163	117					793	263.69
1-2	6	6.93	13	17.23	3	5.00	7	9.68	2	3.14	19	35	22					233	338.49
2-5	13	37.48	16	53.74	6	22.37	1	3.90	1	4.89	9	38	23					265	658.09
5-8	6	36.34	10	64.13	2	15.04			1	6.60	4	5	6					109	694.62
8-10	2	18.32	6	51.69					2	17.69	3	2	2					58	514.84
10-15			3	38.74	2	26.68					2	5	5					77	962.67
15-20			3	54.96							2	2	2					48	810.19
20-25											1	1	1					21	479.35
25-35			2	63.32							2	23.00	2					32	946.25
35-50											66.12							13	515.32
50-60																		6	318.28
60-70																		4	259.86
70-80																		3	218.10
80-90																			
90-100																		1	96.80

CONFIDENTIAL



**CONFIDENTIAL**

**FRAGMENT RECOVERY**

TYPE: 115-mm X378		DATE FIRED: 12 November 1959										ROUND NO.: 2				
FILLER: Composition B																
WEIGHT INTERVALS IN GRAIN	DISTRIBUTION OF FRAGMENTS BY NUMBER AND WEIGHT											TOTAL				
	ZONE 12	ZONE 13	ZONE 14	ZONE 15	ZONE 16	ZONE 17	ZONE 18	ZONE 19								
100-125	NO.														2	
	WT.														212.00	
125-150	NO.															
	WT.															
150-200	NO.														3	
	WT.														525.00	
200-250	NO.												1			
	WT.												249.00		249.00	
250-300	NO.															
	WT.															
300-400	NO.															
	WT.															
400-500	NO.															
	WT.															
500-750	NO.														1	
	WT.														703.00	
750-1000	NO.															
	WT.															
1000 and Over	NO.														1	
	WT.														5185.00	
	NO.															
	WT.															
	NO.															
	WT.															
	NO.															
	WT.															
Total	NO.	39	80	26	9	13	122	259	180						1671	
	WT.	107.59	355.09	76.28	14.30	36.20	292.52	456.77	611.97						14150.55	

**CONFIDENTIAL**

**CONFIDENTIAL**

**FRAGMENT RECOVERY**

TYPE: 115-mm M378		DATE FIRED: 12 November 1959		ROUND NO.: 2		
FILLER: Composition B						
WEIGHT INTERVALS IN GRAIN	DISTRIBUTION OF FRAGMENTS BY NUMBER AND WEIGHT					Grand Total All Frags.
	ZONE 1N	ZONE 2N	TOTAL	ZONE 19B	ZONE 18E	
NO.						903
WT.						239.33
NO.	2		2	9	10	253
WT.	2.65		2.85	12.16	24.63	366.17
NO.				11	20	261
WT.				23.62	60.40	918.49
NO.	1	1	2	1	3	114
WT.	5.24	6.55	12.19	6.27	11.76	725.57
NO.				1	1	59
WT.				8.55	8.55	223.39
NO.	1		1			78
WT.	11.79		11.79			974.46
NO.		1	1	1	1	50
WT.		19.72	19.72	17.73	17.73	47.64
NO.						21
WT.						479.35
NO.				1	1	33
WT.				28.77	28.77	975.02
NO.						13
WT.						515.32
NO.						6
WT.						316.28
NO.						4
WT.						259.66
NO.						3
WT.						216.10
NO.						
WT.						
NO.	1		1			2
WT.	93.42		93.42			190.22

**CONFIDENTIAL**

CONFIDENTIAL

FRAGMENT RECOVERY

WEIGHT INTERVALS IN GRAIN		DISTRIBUTION OF FRAGMENTS BY NUMBER AND WEIGHT										Grand Total All Frags.
		ZONE 1H	ZONE 2H	TOTAL	ZONE 19B	ZONE 18E	TOTAL					
100-125	NO.		1	1								3
	WT.		116.00	116.00								330.00
125-150	NO.											
	WT.											
150-200	NO.											3
	WT.											525.00
200-250	NO.											1
	WT.											249.00
250-300	NO.											
	WT.											
300-400	NO.											
	WT.											
400-500	NO.											
	WT.											
500-750	NO.											1
	WT.											703.00
750-1000	NO.											
	WT.											
1000 and Over	NO.											1
	WT.											3165.00
	NO.											
	WT.											
	NO.											
	WT.											
	NO.											
	WT.											
	NO.											
	WT.											
Total	NO.	5	3	8	100	54	154					1833
	WT.	113.30	144.67	257.97	121.89	62.84	184.73					14593.25

CONFIDENTIAL

CONFIDENTIAL

Table IV (C)  
FRAGMENT RECOVERY

TYPE: 115-mm X378		DATE FIRED: 20 November 1959		ROUND NO.: 3								
FILLER: Composition B		DISTRIBUTION OF FRAGMENTS BY NUMBER AND WEIGHT										
WEIGHT INTERVALS IN GRAIN	ZONE											
	1	2	3	4	5	6	7	8	9	10	11	
0-1	NO. 5			W	2	3	3	20	48	154	277	
	WT. 2.19			o	1.32	1.30	1.39	9.01	15.07	54.19	87.56	
1-2	NO. 2						2	7	6	46	77	
	WT. 6.90			R			3.49	11.22	8.44	66.31	112.83	
2-5	NO. 4	2	1	e	2	1		4	21	59	121	
	WT. 15.19	5.56	4.85	c	4.52	2.53		14.51	65.78	191.78	403.33	
5-8	NO. 1			o		1			10	22	61	
	WT. 5.42			v		5.18			60.93	141.11	374.56	
8-10	NO. 1	1		e					2	9	18	
	WT. 3.70			r					19.78	78.74	163.27	
10-15	NO. 1			y		1			3	14	41	
	WT. 10.50					10.50			38.06	176.15	487.52	
15-20	NO. 1	1							2	7	24	
	WT. 15.90								36.48	117.87	411.06	
20-25	NO. 1	1						1		2	12	
	WT. 24.72	21.45						24.16		42.76	269.96	
25-35	NO. 1										16	
	WT. 25.76										455.54	
35-50	NO. 1		1								9	
	WT. 38.32		38.32								378.04	
50-60	NO. 1		1								7	
	WT. 44.50		44.50								387.40	
60-70	NO. 1										1	
	WT. 61.88										61.88	
70-80	NO. 2										2	
	WT. 148.40										148.40	
80-90	NO. 2										2	
	WT. 171.24										171.24	
90-100	NO. 1											
	WT. 171.24											

22

CONFIDENTIAL

CONFIDENTIAL

FRAGMENT RECOVERY

TYPE: 115-PM X-378		DATE FIRED: 20 November 1959		ROUND NO.: 3								
FILLER: Composition B												
WEIGHT INTERVALS IN GRAIN	DISTRIBUTION OF FRAGMENTS BY NUMBER AND WEIGHT											
	ZONE 1	ZONE 2	ZONE 3	ZONE 4	ZONE 5	ZONE 6	ZONE 7	ZONE 8	ZONE 9	ZONE 10	ZONE 11	
NO.	1	1										
WT.		103.00										
NO.												
WT.												
NO.												
WT.												
NO.		1										
WT.		267.00										
NO.												
WT.												
NO.												
WT.												
NO.												
WT.												
NO.		1										
WT.		335.00										
NO.												
WT.												
NO.												
WT.												
NO.												
WT.												
NO.												
WT.												
NO.												
WT.												
NO.												
WT.												
NO.	20	9	3	-	4	6	5	32	92	313	668	
WT.	54.42	1262.37	97.67	-	5.84	19.81	4.65	58.90	246.54	869.21	3912.61	

CONFIDENTIAL

CONFIDENTIAL

FRAGMENT RECOVERY

TYPE: 115-mm X2878		DATE FIRED: 20 November 1959		ROUND NO.: 3							
FILLER: Composition B		DISTRIBUTION OF FRAGMENTS BY NUMBER AND WEIGHT									
WEIGHT INTERVALS IN GRAIN											TOTAL
	ZONE 12	ZONE 13	ZONE 14	ZONE 15	ZONE 16	ZONE 17	ZONE 18	ZONE 19			
0-1	NO. 19	22	21	6	7	55	60	76			782
	WT. 8.16	8.96	11.06	3.07	1.94	24.27	21.80	23.10			281.39
1-2	NO. 4	16	6		1	21	36	22			249
	WT. 5.49	23.76	8.90		1.35	27.93	49.61	32.03			358.20
2-5	NO. 7	22	9	4	2	15	29	31			333
	WT. 19.98	69.71	25.46	11.70	5.52	47.05	84.71	96.99			1060.97
5-8	NO. 1	10	1	1		11	11	12			112
	WT. 7.42	61.41	6.22	7.36		70.34	67.52	72.96			880.43
8-10	NO. 6	6	1		1		6	2			40
	WT. 57.36	9.50			3.94		72.71	16.44			435.16
10-15	NO. 4	3	1			3	9	2			61
	WT. 45.90	37.13	11.75			39.14	100.64	26.77			982.18
15-20	NO. 4	4					2	1			41
	WT. 69.42						35.83	17.48			704.05
20-25	NO. 1	1				1		1			20
	WT. 21.60					24.72		22.35			451.72
25-35	NO. 2	2									19
	WT. 52.51										533.01
35-50	NO. 3						3	1			14
	WT. 131.60						131.60	11.40			509.44
50-60	NO. 6										6
	WT. 441.90										441.90
60-70	NO. 1										1
	WT. 61.88										61.88
70-80	NO. 2										2
	WT. 148.40										148.40
80-90	NO. 2										2
	WT. 171.24										171.24
90-100	NO. 1										1
	WT. 171.24										171.24

22

CONFIDENTIAL

CONFIDENTIAL

FRAGMENT RECOVERY

WEIGHT INTERVALS IN GRAIN		DISTRIBUTION OF FRAGMENTS BY NUMBER AND WEIGHT													TOTAL		
		ZONE 12	ZONE 13	ZONE 14	ZONE 15	ZONE 16	ZONE 17	ZONE 18	ZONE 19								
100-125	NO.																1
	WT.																103.00
125-150	NO.																
	WT.																
150-200	NO.																
	WT.																
200-250	NO.																
	WT.																
250-300	NO.																1
	WT.																267.00
300-400	NO.																1
	WT.																306.00
400-500	NO.																
	WT.																
500-750	NO.																
	WT.																
750-1000	NO.																1
	WT.																635.00
1000 and Over	NO.																
	WT.																
	NO.																
	WT.																
	NO.																
	WT.																
	NO.																
	WT.																
Total	NO.	35	66	36	11	11	106	156	149								1746
	WT.	66.95	401.90	72.79	22.13	17.79	233.45	575.30	655.52								8620.06

29

CONFIDENTIAL

CONFIDENTIAL

FRAGMENT RECOVERY

TYPE: 11.4-mm X-378 DATE FIRED: 20 November 1959 ROUND NO.: 3  
 FILLER: Composition B

WEIGHT INTERVALS IN GRAIN	DISTRIBUTION OF FRAGMENTS BY NUMBER AND WEIGHT										Grand Total All Frags.	
	NO.	WT.	NO.	WT.	NO.	WT.	NO.	WT.	NO.	WT.		TOTAL
	ZONE 1N	ZONE 2N	TOTAL	ZONE 19B	ZONE 18B	TOTAL						
0-1	6	3	11	25	14	39						832
	3.72	1.44	5.16	10.03	6.92	17.00						303.55
1-2	4		4	5	7	12						265
	5.15		5.15	6.11	9.66	16.09						379.47
2-5	1	1	2	6	4	10						345
	2.09	4.70	6.79	21.39	12.54	33.95						1109.05
5-8		1	1	3	2	5						146
		5.73	5.73	19.66	10.96	30.62						916.80
8-10				3		3						51
				27.01		27.01						462.47
10-15	1	1	2									63
	10.12	10.13	20.25									1002.44
15-20	1		1	1		1						43
	15.07		15.07	16.72		16.72						737.85
20-25	2		2									22
	25.04		45.64									457.56
25-30												19
												533.81
35-50												14
												569.44
50-60												6
												141.90
60-70		1	1									2
		62.82	62.82									124.70
70-80												2
												118.10
80-90												2
												171.24
90-100												

CONFIDENTIAL



CONFIDENTIAL

FRAGMENT RECOVERY

TYPE: 115-mm X373		DATE FIRED: 20 November 1959		ROUND NO.: 3						
FILLER: Composition B										
WEIGHT INTERVALS IN GRAIN	DISTRIBUTION OF FRAGMENTS BY NUMBER AND WEIGHT									Grand Total All Frags.
	NO.	WT.	ZONE 1N	ZONE 2N	TOTAL	ZONE 19B	ZONE 18B	TOTAL		
100-125										1
	NO.									103.00
	WT.									
125-150										
	NO.									
	WT.									
150-200										
	NO.									
	WT.									
200-250										
	NO.									
	WT.									
250-300										
	NO.									1
	WT.									267.00
300-400										
	NO.									1
	WT.									306.00
400-500										
	NO.									
	WT.									
500-750										
	NO.									
	WT.									
750-1000										
	NO.									1
	WT.									835.00
1000 and Over										
	NO.	1								1
	WT.	5761.00								5761.00
	NO.									
	WT.									
	NO.									
	WT.									
	NO.									
	WT.									
	NO.									
	WT.									
	NO.									
	WT.									
	NO.									
	WT.									
Total	NO.	18	7	25	43	27	70	1841		
	WT.	5843.03	84.82	5927.85	103.25	40.10	143.35	14691.28		

CONFIDENTIAL

# CONFIDENTIAL

## 3.3 Analysis of Data

(U) The initial velocity ( $V_0$ ) of the fragments was obtained by using the following equation:

$$V_0 = V_p \frac{e^{\frac{ar}{m_r l/3}} - 1}{\frac{ar}{m_r l/3}} \quad \text{where}$$

$V_p$  = photographic velocity, fps.

$r$  = distance from shell to target, feet.

$m_r$  = the representative fragment weight, grains.

$a = 12 K_{dp} k^{-2/3}$ ; where  $K$  is the fragment shape factor,  $p$  is the air density in grains/inch<sup>3</sup>, and  $K_d$  is the representative fragment drag coefficient. For a more complete and detailed definition see Appendix C.

The initial fragment velocities for each 10° increment are shown in Table V.

Table V (C). Average Fragment Velocity and Density, Rounds 1, 2, and 3

Zone	Degree	Initial Velocity, fps	Density Fragments/Steradian
1	0	2100	1707
2	10	1950	392
3	20	<sup>a</sup> 2550	24
4	30	<sup>a</sup> 3200	42
5	40	3800	265
6	50	3000	300
7	60	4900	267
8	70	5550	694
9	80	6200	2124
10	90	7300	6300
11	100	6300	13,999
12	110	7200	1112
13	120	4500	2140
14	130	3150	900
15	140	4100	369
16	150	3300	239
17	160	3250	2780
18	170	4350	4513
19	180	4600	9594

<sup>a</sup>Interpolated value.

(U) Table VI presents the number and weight of fragments recovered and the integrated data scaled to 100 per cent recovery for each round.

# CONFIDENTIAL

# CONFIDENTIAL

Table VI (C). Actual and Integrated Recovery

Actual Recovery				
Round No.	Total Weight, gr	Total Number of Fragments <sup>a</sup>	Average Fragment Weight, gr	As Fired Metal Parts Weight, lb
1	14,374.12	1886	7.62	23.67
2	14,593.25	1833	7.96	23.55
3	14,691.28	1841	7.98	23.14
Average	14,552.88	1853	7.85	23.45

<sup>a</sup>Including fragment recovery from the extra nose and base boxes placed at 35 feet.

Integrated Recovery					
Round No.	Weight, lb	Number of Fragments	Average Fragment Weight, gr	Per Cent Recovery	Scaled Number of Fragments
1	22.26	31,836	4.90	94.1	33,841
2	21.17	24,903	5.95	89.9	27,717
3	20.18	30,328	4.66	87.2	34,787
Average	21.20	29,022	5.11	90.4	32,115

(U) The total number of fragments produced was determined by the following equation:

$$N = 2\pi \int_0^{\pi} \sigma(\theta) \sin \theta d\theta$$

where  $\sigma(\theta)$  = Scaled number of fragments per unit solid angle (Steradian).

$\theta$  = Angle from axis of shell as measured from the nose.

See Table V for fragment density.

(C) The data in the above table shows approximately 20 per cent fewer fragments for round 2 than for the average of the other two rounds. A further separation was made to more clearly define the differences in the scaled number of fragments for the three rounds.

(U) Table VII presents the total number of scaled fragments per angular interval.

## CONFIDENTIAL

Table VII (C). Total Scaled Fragments per Angular Interval

<u>Round No.</u>	<u>0° to 75°</u>	<u>75° to 115°</u>	<u>115° to 180°</u>
1	1315	27,691	4836
2	2008	20,392	5317
3	1296	28,224	5266

(C) As shown in Table VII, approximately 79 per cent of the fragments were in an angular interval extending from 75° to 115°. A difference of approximately 8000 fragments is shown between round 2 and the average of rounds 1 and 3 for this same angular interval. Since 44 per cent of the total fragments were in the smallest weight interval (0 to 1 grain), a tabulation of the number of fragments excluding the fragments in this weight interval is given in Table VIII below.

Table VIII (C). Number of Fragments per Angular Interval  
(Excluding Fragments Weighing Less than One Grain)

<u>Round No.</u>	<u>0° to 75°</u>	<u>75° to 115°</u>	<u>115° to 180°</u>	<u>Total, 0° to 180°</u>
1	700	14,873	2631	18,204
2	801	13,224	2676	16,701
3	564	15,539	3117	19,220

(C) From these data it is apparent that most of the difference occurred in the number of fragments weighing less than one grain. However, it is indicated that round 2 produced slightly heavier fragments.

#### 4. (C) CONCLUSIONS

It is concluded that:

- a. Shell, 115-mm, XM378, Composition B loaded, will produce an average of 32,115 fragments weighing 5.11 grains, and having a mean initial velocity of 4279 feet per second.
- b. Forty-four per cent of the total number of scaled fragments were in the weight interval of 0 to 1 grain.
- c. Seventy-nine per cent of the fragments were found to be from the 75° to 115° angular section of the shell.
- d. A lethality study is being conducted and will be reported under separate cover.

## CONFIDENTIAL

## CONFIDENTIAL

### 5. (C) RECOMMENDATIONS

Further investigation should be conducted regarding the use of different tensile strength pearlitic malleable iron shell casings for the development of a shell that will reduce the number of small fragments (0 to 1 grain) produced by the XM378 shell.

#### SUBMITTED:

*J. T. Dempsey*  
J. T. DEMPSEY  
Ordnance Technician

#### REVIEWED:

*V. L. Grafon*  
V. L. GRAFON  
Chief, Terminal Effects  
and Special Projects Branch

*Claude E. Brown*  
C. E. BROWN  
Chief, Infantry and  
Aircraft Weapons Division

#### APPROVED:

*H. A. Noble*  
H. A. NOBLE  
Assistant Deputy Director  
for Engineering Testing  
Development and Proof Services

## CONFIDENTIAL

APPENDICES

	<u>PAGE</u>
A, CORRESPONDENCE . . . . .	A-1
B, INDIVIDUAL FRAGMENT WEIGHTS . . . . .	B-1
C, ANALYTICAL LABORATORY REPORT . . . . .	C-1
D, DISTRIBUTION . . . . .	D-1

**CONFIDENTIAL**

APPENDIX A  
Correspondence

ORDNANCE CORPS  
PICATINNY ARSENAL  
DOVER, NEW JERSEY

Mr. J. V. Sagarese/sjg/2251

IN REPLY  
REFER TO:  
FELTMAN RESEARCH AND ENGINEERING LABORATORIES  
ORDBE-IE3 470

AUG 25 89 -3 PM

SUBJECT: Shell, IE, 115 mm XM378 (Project No. TW-201) (U)

TO: Commanding General  
Aberdeen Proving Ground  
Maryland  
ATTENTION: ORDBG-DP-TI (Mr. M. Raabe)

1. (C) It is requested that complete fragmentation data be obtained from three of the five 115 mm XM378 IE Shell furnished. The desired data should include fragment velocity, fragment mass and spatial distribution. The data thus obtained will be used to determine lethality of subject shell. Fragment velocity is expected to be in the order of 5455 f/s.

2. (U) It is desired that the Analytical Laboratory oversee the test procedure and set-up. Further, it is desired that the Analytical Laboratory reduce the data and put the information in a form acceptable to the Weapons Systems Laboratory of Ballistic Research Laboratories.

3. (U) The Weapons Systems Laboratory of Ballistic Research Laboratories is requested to calculate the lethality of subject shell based upon the fragmentation data furnished.

4. (U) The shell metal parts weights have been taken and are furnished herewith:

Shell No. 1	- - - - -	22.16 lbs.
Shell No. 2	- - - - -	22.04 lbs.
Shell No. 3	- - - - -	22.22 lbs.
Shell No. 4	- - - - -	21.35 lbs.
Shell No. 5	- - - - -	21.63 lbs.

5. (U) The loaded shell weights have been taken and are furnished herewith:

Shell No. 1	- - - - -	32.55 lbs.
Shell No. 2	- - - - -	32.45 lbs.
Shell No. 3	- - - - -	32.62 lbs.
Shell No. 4	- - - - -	31.91 lbs.
Shell No. 5	- - - - -	32.15 lbs.

The above shell are to be fired in the order of 1, 2, 5, 3 and 4.

*Ag. Concept.*

A-1

*EC-21-59*

**CONFIDENTIAL**

*7597*

*MR. RAABE  
EC-21-59-3691*

# CONFIDENTIAL

ORDBB-TE3 470

SUBJECT: Shell, HE, 115 mm XM378 (Project No. TW-201) (U)

6. (U) Drawings Nos. DXP-106156 and -107800 delineating shell metal parts and loading assembly, respectively, are inclosed. Although a large stud is shown on Drawing No. DXP-106156, this stud has been removed. On Drawing No. DXP-107800, inert filler is indicated which has been replaced with H. E. (Comp B) filler.

7. (U) The priority of this work is 1A; an early test is requested. It is desired that notification of this test be furnished at least three days in advance of the test to permit attendance by interested personnel.

8. (U) Funds required for this test have been estimated at \$4,000 per shell. Accordingly, since data from three shells are required, \$12,000 is furnished herewith. In the event of an unusual occurrence which necessitates additional testing, funds will be furnished subsequently. Funds amounting to \$12,000 on AIF Order No. 07110100-99-60037 have been forwarded.

FOR THE COMMANDER:

*W. F. Shank*  
W. F. SHANK  
A-2

✓ 2 Incls

1-2. Prts Dwgs. Nos.  
DXP-106156<sup>(2)</sup> and  
-107800 (x)

CC  
AFG, ORDEG-DEPS,  
Analytical Lab  
AFG, ORDEG-ERL,  
Wpns Systems Lab,  
w/Incls 1 & 2

A-2

# CONFIDENTIAL



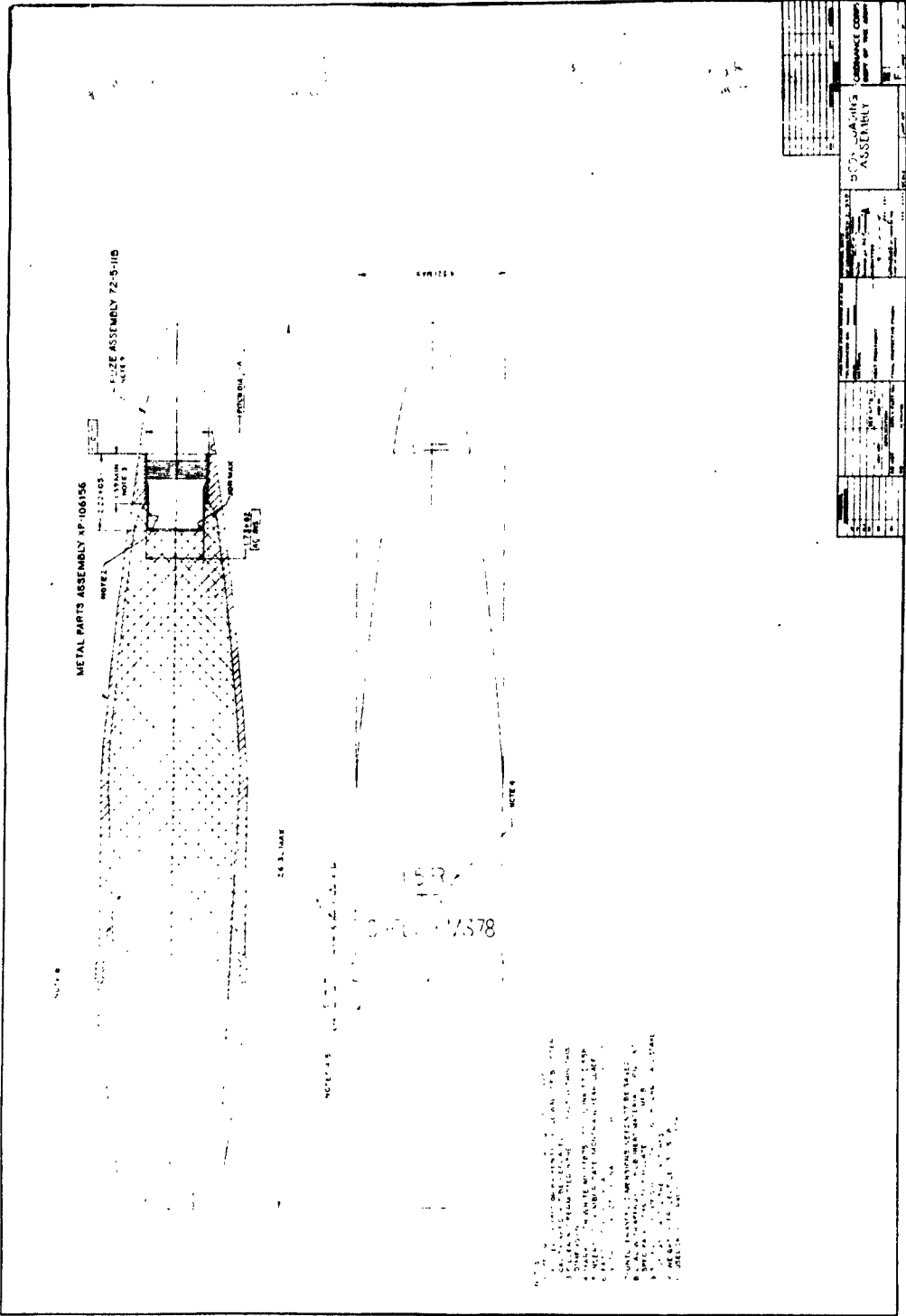

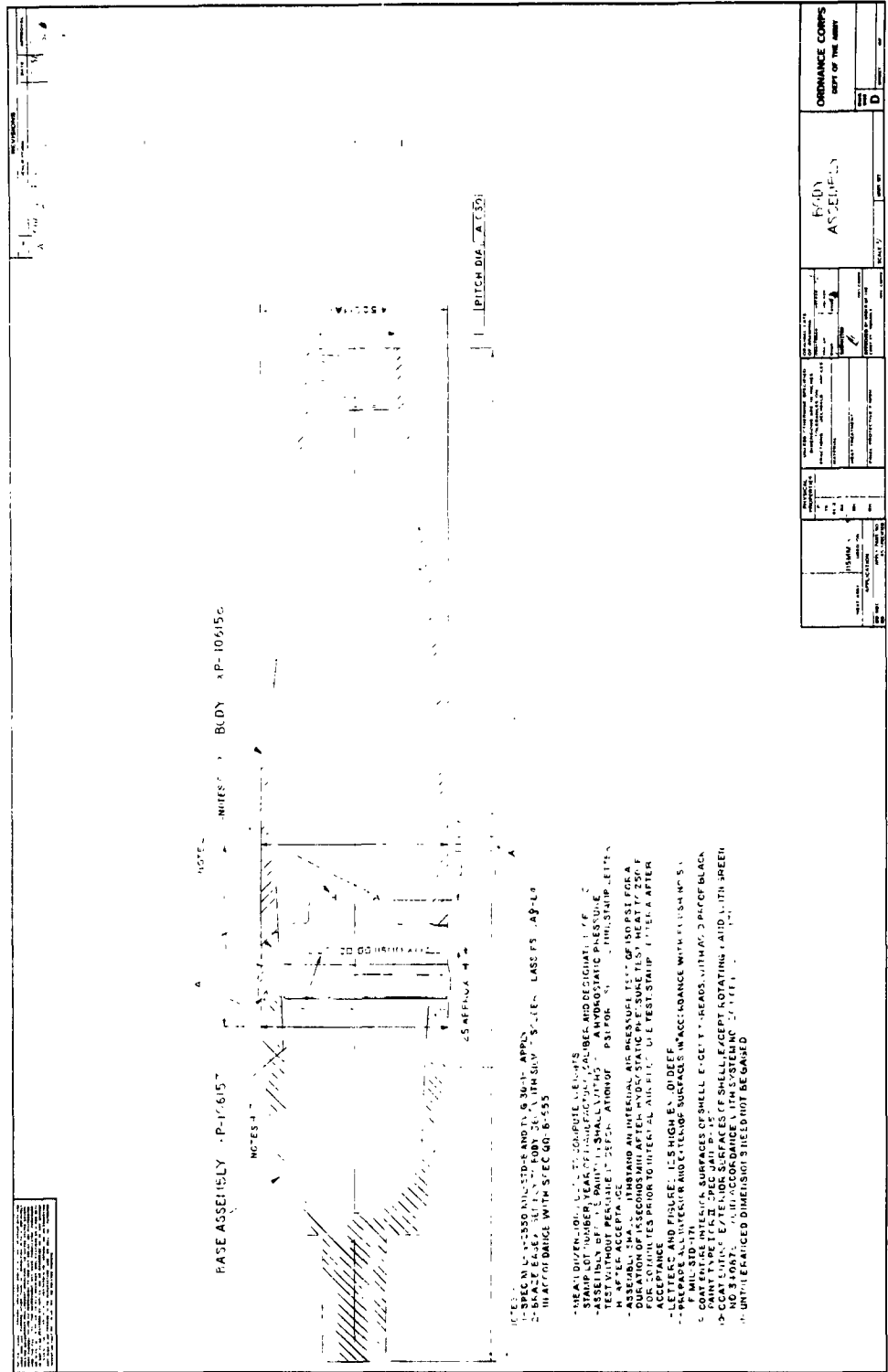

BASE ASSEMBLY - P-10615

NOTES

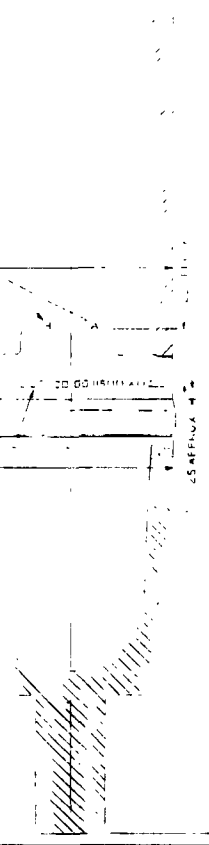

- 1- SPEC IN 1/4" DIA AND 1/4" 30-1" APPL.
- 2- BRACE BASE, LEFT, BODY DIA. WITH SILV. 3-1/2" DIA. LAST FS. AS-LS
- 3- MATERIAL BRIDGE WITH SPEC GR. B-555
- 4- MATERIAL FIN. DIA. 1/4" 30-1" APPL.
- 5- START LOT NUMBER YEAR OF MANUFACTURE, CALIBER AND DESIGNATION OF ASSEMBLY OF 1/4" DIA. 1/4" SMALL WITH 1/4" AM HYDROSTATIC PRESSURE TEST WITHOUT PRESSURE 1/4" 30-1" APPL. OF 1/4" DIA. 1/4" 30-1" APPL.
- 6- ASSEMBLY DIA. 1/4" 30-1" APPL. WITH AN INTERNAL AIR PRESSURE TEST OF 150 PSI FOR A DURATION OF 15 SECONDS IMMEDIATELY AFTER HYDROSTATIC PRESSURE TEST OF 150 PSI FOR ACCEPTANCE TESTS PRIOR TO INTERNAL AIR PRESSURE TESTS.
- 7- LETTERS AND FIGURES: 1/4" HIGH, 0.015" DEEP.
- 8- PAINT: INTERIOR SURFACES OF SHELL: BLACK. EXTERIOR SURFACES: BLACK.
- 9- COAT FINISH: INTERIOR SURFACES OF SHELL: BLACK. EXTERIOR SURFACES: BLACK.
- 10- PAINT: INTERIOR SURFACES OF SHELL: BLACK. EXTERIOR SURFACES: BLACK.
- 11- ACCORDANCE WITH SYSTEMING 1/4" 30-1" APPL.
- 12- UNDIMENSIONED DIMENSIONS NEED NOT BE GAGED.

# CONFIDENTIAL

## APPENDIX B

### Individual Fragment Weights

115-mm, XM378  
Round No. 1  
4 November 1959

<u>Zone</u>	<u>Weight</u>	<u>Code</u>	<u>Zone</u>	<u>Weight</u>	<u>Zone</u>	<u>Weight</u>
1	945.00	F	6	94.14	8	0.12
	105.00	F		11.10		0.10
	14.84	F		11.00		0.10
	11.43	F		4.77		0.10
	6.36	F		2.70		0.09
	5.02	F		2.42		0.07
	4.98	F		1.72		0.07
	2.84	F		0.80		0.05
	2.13	F		0.74		0.05
	1.71	F		0.50		0.03
	1.54	F		0.28		
	1.20	F			Total	29.87
	0.34	F	Total	130.17		
Total	1102.39		7	15.80	9	31.86
				4.80		20.70
2	23.13	F		3.06		13.86
	21.92	F		2.78		11.77
	1.84	F		2.72		11.73
	0.75	F		0.97		9.09
	0.24	F		0.20		9.00
Total	47.88			0.13		8.73
			Total	30.46		7.86
3	NR					7.55
			8	5.00		7.50
4	8.39			4.87		7.40
Total	8.39			3.50		6.75
				3.47		6.69
5	86.22			2.55		5.68
	22.58			2.19		5.60
	5.35			1.89		5.25
	4.74			1.61		5.02
	4.11			1.50		4.26
	2.58			0.90		4.22
	1.94			0.71		4.12
	1.24			0.22		4.05
	0.46			0.21		3.95
	0.43			0.20		3.94
Total	129.65			0.15		3.86
				0.12		3.77
						3.57
						3.28
						3.12

B-1

# CONFIDENTIAL

# CONFIDENTIAL

<u>Zone</u>	<u>Weight</u>	<u>Zone</u>	<u>Weight</u>	<u>Zone</u>	<u>Weight</u>
9	3.00	9	0.35	10	15.49
	2.91		0.35		14.70
	2.85		0.30		14.46
	2.69		0.30		14.39
	2.60		0.26		13.74
	2.40		0.26		13.62
	2.32		0.25		13.39
	2.17		0.21		12.98
	1.92		0.21		12.82
	1.80		0.19		12.49
	1.80		0.18		11.93
	1.74		0.18		11.19
	1.66		0.17		11.14
	1.59		0.16		10.96
	1.59		0.16		10.85
	1.50		0.13		10.62
	1.50		0.12		10.25
	1.48		0.12		9.65
	1.48		0.10		9.60
	1.45		0.10		9.55
	1.35		0.10		9.42
	1.30		0.10		9.30
	1.30		0.09		9.25
	1.22		0.08		9.06
	1.14		0.08		8.89
	1.06		0.07		8.80
	1.00		0.07		8.73
	0.95		0.06		8.72
	0.95		0.06		8.53
	0.93		0.05		8.50
	0.91		0.05		8.38
	0.86		0.04		8.32
	0.85		0.03		8.18
	0.84				8.10
	0.72	Total	289.09		7.74
	0.70				7.65
	0.64	10	28.80		7.49
	0.62		21.10		7.45
	0.57		20.30		7.44
	0.48		20.24		7.44
	0.38		17.34		7.42
	0.36		16.95		7.33
	0.35		15.73		6.95

# CONFIDENTIAL

<u>Zone</u>	<u>Weight</u>	<u>Zone</u>	<u>Weight</u>	<u>Zone</u>	<u>Weight</u>
10	6.90	10	2.80	10	1.76
	6.80		2.80		1.72
	6.75		2.80		1.69
	6.45		2.80		1.69
	6.34		2.76		1.67
	6.25		2.72		1.62
	6.23		2.70		1.60
	5.93		2.69		1.53
	5.85		2.65		1.52
	5.40		2.65		1.50
	5.13		2.65		1.49
	4.98		2.60		1.45
	4.97		2.56		1.45
	4.88		2.56		1.44
	4.80		2.51		1.39
	4.78		2.50		1.36
	4.55		2.43		1.36
	4.47		2.42		1.36
	4.46		2.40		1.32
	4.35		2.39		1.30
	4.30		2.35		1.25
	4.10		2.33		1.18
	4.08		2.17		1.15
	4.07		2.17		1.06
	3.90		2.12		1.06
	3.90		2.10		1.06
	3.80		2.10		1.00
	3.80		2.09		0.97
	3.65		2.05		0.96
	3.64		2.05		0.94
	3.56		2.00		0.94
	3.55		1.91		0.90
	3.50		1.90		0.90
	3.29		1.86		0.90
	3.25		1.86		0.90
	3.16		1.82		0.90
	3.15		1.80		0.86
	3.11		1.80		0.85
	3.10		1.80		0.85
	3.02		1.80		0.85
	3.00		1.76		0.83
	2.90		1.76		0.82
	2.83		1.76		0.80
					0.77

# CONFIDENTIAL

<u>Zone</u>	<u>Weight</u>	<u>Zone</u>	<u>Weight</u>	<u>Zone</u>	<u>Weight</u>
10	0.77	10	0.35	10	0.11
	0.76		0.34		0.10
	0.75		0.33		0.10
	0.75		0.32		0.10
	0.75		0.32		0.10
	0.74		0.32		0.09
	0.74		0.32		0.09
	0.74		0.32		0.09
	0.73		0.30		0.09
	0.73		0.30		0.09
	0.73		0.29		0.09
	0.70		0.28		0.07
	0.68		0.28		0.06
	0.67		0.25		0.05
	0.67		0.25		0.05
	0.66		0.25		0.05
	0.66		0.25		0.05
	0.65		0.23		0.05
	0.64		0.22		0.04
	0.64		0.22		0.04
	0.60		0.22		0.04
	0.60		0.21		0.03
	0.58		0.20		0.03
	0.56		0.20		0.03
	0.55		0.20		0.03
	0.55		0.20		0.03
	0.55		0.18		0.03
	0.54		0.18		0.03
	0.53		0.18		0.03
	0.53		0.18		0.02
	0.52		0.17		0.02
	0.52		0.17		0.02
	0.51		0.16		0.02
	0.50		0.16		0.02
	0.50		0.16		0.02
	0.50		0.16		0.02
	0.50		0.15		0.02
	0.48		0.15		0.02
	0.48		0.15		0.02
	0.47		0.15		0.02
	0.46		0.15		0.02
	0.45		0.14		0.02
	0.43		0.12		0.02
	0.43		0.12		0.02
	0.42		0.12		0.02
	0.42		0.12		0.02
	0.42		0.12		0.02
	0.40		0.12		0.02
	0.40		0.12		0.02
	0.38		0.12		0.02
				Total	956.23
				11	108.00
					105.00
					92.80
					91.00
					88.80
					71.20
					68.28
					61.80
					59.64

B-4

# CONFIDENTIAL

# CONFIDENTIAL

<u>Zone</u>	<u>Weight</u>	<u>Zone</u>	<u>Weight</u>	<u>Zone</u>	<u>Weight</u>
11	58.60	11	17.05	11	9.87
	56.66		16.57		9.84
	54.84		16.27		9.53
	54.00		16.13		9.46
	45.58		15.97		9.40
	42.44		15.96		9.25
	41.00		15.62		9.25
	40.60		15.53		9.23
	39.58		15.28		9.05
	37.20		15.00		9.02
	34.00		15.00		8.90
	33.82		14.69		8.85
	33.78		14.65		8.84
	32.20		14.56		8.77
	32.18		14.46		8.74
	31.70		14.17		8.58
	30.24		14.12		8.53
	29.62		14.10		8.50
	29.30		14.07		8.35
	29.06		14.01		8.30
	28.75		13.80		8.27
	28.18		13.41		8.20
	27.45		13.21		8.13
	27.17		13.07		8.05
	26.08		13.03		7.98
	24.80		12.89		7.91
	23.68		12.79		7.67
	23.45		12.71		7.66
	23.38		12.60		7.56
	23.25		12.53		7.55
	22.65		12.10		7.38
	22.62		11.92		7.37
	22.24		11.82		7.35
	22.14		11.60		7.35
	21.45		11.55		7.25
	20.06		11.46		7.23
	19.94		11.12		7.10
	19.70		10.80		7.09
	19.67		10.80		7.07
	19.60		10.79		7.04
	19.10		10.75		7.04
	18.85		10.75		6.97
	18.71		10.70		6.95
	18.69		10.61		6.94
	18.62		10.60		6.94
	17.75		10.52		6.93
	17.60		10.45		6.80
	17.58		10.44		6.70
	17.14		10.15		6.60
	17.09		9.99		6.53

B-5

# CONFIDENTIAL

# CONFIDENTIAL

<u>Zone</u>	<u>Weight</u>	<u>Zone</u>	<u>Weight</u>	<u>Zone</u>	<u>Weight</u>
11	6.32	11	4.06	11	3.00
	6.30		4.03		3.00
	5.85		4.02		2.92
	5.77		4.00		2.92
	5.76		4.00		2.85
	5.75		4.00		2.83
	5.74		3.97		2.80
	5.74		3.96		2.76
	5.69		3.92		2.76
	5.67		3.87		2.72
	5.63		3.86		2.70
	5.60		3.85		2.62
	5.48		3.83		2.50
	5.45		3.82		2.50
	5.39		2.75		2.45
	5.38		3.74		2.45
	5.30		3.70		2.44
	5.30		3.69		2.41
	5.20		3.68		2.39
	5.18		3.60		2.39
	5.16		3.57		2.35
	5.13		3.56		2.34
	5.12		3.55		2.31
	5.11		3.55		2.31
	5.10		3.52		2.30
	5.00		3.50		2.30
	4.88		3.50		2.29
	4.77		3.49		2.28
	4.76		3.44		2.28
	4.75		3.40		2.27
	4.68		3.36		2.26
	4.68		3.34		2.24
	4.67		3.32		2.24
	4.63		3.31		2.19
	4.62		3.30		2.18
	4.60		3.29		2.17
	4.59		3.28		2.16
	4.58		3.24		2.00
	4.53		3.22		2.00
	4.53		3.20		1.99
	4.40		3.20		1.95
	4.37		3.19		1.94
	4.35		3.17		1.91
	4.33		3.12		1.90
	4.24		3.11		1.90
	4.21		3.11		1.90
	4.20		3.07		1.89
	4.16		3.05		1.89
	4.11		3.02		1.85
	4.08		3.01		1.82

B-6

# CONFIDENTIAL



**CONFIDENTIAL**

<u>Zone</u>	<u>Weight</u>	<u>Zone</u>	<u>Weight</u>	<u>Zone</u>	<u>Weight</u>
11	1.82	11	1.24	11	0.81
	1.78		1.20		0.81
	1.75		1.19		0.80
	1.74		1.18		0.79
	1.69		1.14		0.79
	1.69		1.12		0.78
	1.67		1.10		0.77
	1.67		1.09		0.76
	1.65		1.09		0.75
	1.64		1.09		0.75
	1.62		1.06		0.74
	1.60		1.05		0.73
	1.60		1.05		0.70
	1.59		1.04		0.69
	1.58		1.04		0.66
	1.57		1.04		0.65
	1.57		1.03		0.65
	1.57		1.03		0.64
	1.55		1.02		0.64
	1.54		1.02		0.62
	1.53		1.00		0.62
	1.50		1.00		0.62
	1.50		0.99		0.62
	1.50		0.99		0.61
	1.50		0.99		0.60
	1.49		0.98		0.58
	1.45		0.98		0.58
	1.43		0.97		0.57
	1.42		0.96		0.56
	1.41		0.94		0.55
	1.40		0.94		0.55
	1.39		0.93		0.55
	1.39		0.93		0.55
	1.39		0.92		0.54
	1.39		0.92		0.53
	1.36		0.90		0.52
	1.35		0.90		0.51
	1.34		0.90		0.50
	1.33		0.90		0.50
	1.32		0.90		0.50
	1.31		0.90		0.50
	1.30		0.89		0.49
	1.29		0.89		0.49
	1.27		0.86		0.46
	1.26		0.86		0.46
	1.25		0.85		0.44
	1.24		0.85		0.44
	1.22		0.85		0.44
	1.22		0.84		0.41
	1.22		0.82		0.40

B-7

**CONFIDENTIAL**

# CONFIDENTIAL

<u>Zone</u>	<u>Weight</u>	<u>Zone</u>	<u>Weight</u>	<u>Zone</u>	<u>Weight</u>
11	0.40	11	0.22	11	0.10
	0.40		0.21		0.10
	0.39		0.20		0.10
	0.39		0.20		0.10
	0.39		0.20		0.10
	0.38		0.20		0.10
	0.38		0.20		0.09
	0.38		0.20		0.09
	0.36		0.20		0.09
	0.36		0.19		0.09
	0.36		0.19		0.09
	0.35		0.18		0.08
	0.35		0.18		0.08
	0.35		0.17		0.08
	0.35		0.17		0.08
	0.34		0.17		0.08
	0.34		0.17		0.08
	0.33		0.17		0.08
	0.33		0.16		0.08
	0.33		0.16		0.08
	0.33		0.16		0.08
	0.32		0.16		0.08
	0.32		0.16		0.08
	0.32		0.16		0.08
	0.30		0.15		0.08
	0.30		0.15		0.08
	0.30		0.15		0.08
	0.30		0.15		0.08
	0.30		0.15		0.08
	0.29		0.15		0.08
	0.29		0.15		0.08
	0.29		0.14		0.08
	0.29		0.14		0.08
	0.29		0.14		0.07
	0.29		0.13		0.07
	0.29		0.13		0.07
	0.28		0.13		0.07
	0.28		0.12		0.07
	0.28		0.12		0.07
	0.27		0.12		0.07
	0.26		0.12		0.07
	0.26		0.12		0.07
	0.25		0.11		0.06
	0.25		0.10		0.06
	0.24		0.10		0.06
	0.24		0.10		0.06
	0.24		0.10		0.06
	0.24		0.10		0.06
	0.23		0.10		0.06

**CONFIDENTIAL**

<u>Zone</u>	<u>Weight</u>	<u>Zone</u>	<u>Weight</u>	<u>Zone</u>	<u>Weight</u>
11	0.06	11	0.02	12	1.99
	0.06		0.02		1.89
	0.05		0.02		1.65
	0.05		0.02		1.56
	0.05		0.02		1.55
	0.05		0.02		1.65
	0.05		0.01		1.32
	0.05		0.01		1.30
	0.05		0.01		1.29
	0.05		0.01		1.28
	0.05		0.01		1.22
	0.05		0.01		1.14
	0.05		0.01		0.98
	0.05		0.01		0.98
	0.05		0.01		0.91
	0.05		0.01		0.80
	0.05		0.01		0.80
	0.05		0.01		0.80
	0.05		0.01		0.65
	0.05		0.01		0.64
	0.05		0.01		0.60
	0.05		0.01		0.53
	0.05		0.01		0.48
	0.04		0.01		0.44
	0.04		0.01		0.42
	0.04		0.01		0.35
	0.04		0.01		0.33
	0.04		0.01		0.32
	0.04		0.01		0.32
	0.04	Total	3948.63		0.30
	0.04	12	13.92		0.27
	0.04		11.78		0.27
	0.03		10.39		0.22
	0.03		10.10		0.20
	0.03		8.65		0.18
	0.03		8.46		0.17
	0.03		8.46		0.16
	0.03		5.60		0.16
	0.03		5.22		0.15
	0.03		4.90		0.15
	0.03		4.61		0.13
	0.03		4.61		0.09
	0.03		3.65		0.07
	0.03		3.65		0.06
	0.03		3.31		0.06
	0.02		3.17		0.05
	0.02		3.17		0.05
	0.02		2.95		0.05
	0.02		2.93		0.03
	0.02		2.90		0.03
	0.02		2.73		0.01
	0.02		2.04	Total	141.77

# CONFIDENTIAL

<u>Zone</u>	<u>Weight</u>	<u>Zone</u>	<u>Weight</u>	<u>Zone</u>	<u>Weight</u>
13	32.40	13	1.93	14	0.24
	29.76		1.75		0.21
	25.47		1.69		0.20
	15.45		1.65		0.17
	13.70		1.49		0.15
	12.17		1.25		0.14
	10.95		1.15		0.09
	10.75		1.14		0.07
	10.17		1.10		0.05
	10.04		1.00		0.05
	9.82		0.92		0.04
	9.60		0.89		
	8.55		0.87	Total	63.99
	7.80		0.86		
	7.62		0.74	15	19.05
	7.55		0.60		3.82
	7.37		0.58		3.50
	7.14		0.42		3.33
	6.32		0.38		3.29
	6.22		0.25		2.68
	6.15		0.20		1.50
	6.10		0.18		1.14
	6.04		0.30		0.85
	5.55		0.16		0.80
	5.36		0.15		0.65
	5.13		0.14		0.65
	7.04		0.11		0.64
	4.40		0.10		0.63
	4.48		0.08		0.60
	3.85		0.06		0.60
	3.26		0.04		0.59
	3.25		0.03		0.47
	3.44				0.38
	3.18	Total	380.31	Total	45.17
	3.17				
	3.07	14	25.27	16	3.44
	2.97		8.14		1.85
	2.86		6.67		0.45
	2.82		4.65		0.35
	2.80		4.49		
	2.78		2.98	Total	6.09
	2.77		2.29		
	2.73		2.09	17	19.20
	2.52		1.97		18.52
	2.41		1.69		12.30
	2.36		0.74		11.14
	2.30		0.55		10.78
	2.27		0.50		10.69
	2.13		0.30		9.78
	2.06		0.25		

B-10

# CONFIDENTIAL

# CONFIDENTIAL

<u>Zone</u>	<u>Weight</u>	<u>Zone</u>	<u>Weight</u>	<u>Zone</u>	<u>Weight</u>
17	8.75	17	0.65	17	0.14
	8.53		0.59		0.14
	8.00		0.55		0.14
	6.06		0.55		0.13
	5.75		0.54		0.12
	5.75		0.53		0.12
	5.57		0.52		0.12
	5.02		0.51		0.12
	5.00		0.48		0.11
	4.42		0.47		0.10
	4.26		0.44		0.10
	3.87		0.44		0.10
	3.56		0.41		0.10
	2.82		0.40		0.09
	2.70		0.39		0.09
	2.64		0.38		0.09
	2.54		0.38		0.08
	2.37		0.38		0.08
	2.30		0.37		0.06
	2.17		0.34		0.05
	2.11		0.34		0.05
	2.00		0.33		0.04
	1.99		0.33		0.04
	1.94		0.30		0.04
	1.86		0.29		0.02
	1.80		0.28		0.95
	1.80		0.28		0.98
	1.80		0.26		0.90
	1.79		0.25		0.89
	1.75		0.25		
	1.65		0.23	Total	249.29
	1.65		0.23		
	1.64		0.22	18	22.15
	1.60		0.20		20.69
	1.52		0.20		20.00
	1.49		0.20		19.78
	1.45		0.20		16.30
	1.30		0.20		15.80
	1.25		0.20		14.23
	1.17		0.19		12.68
	1.14		0.18		12.09
	1.11		0.18		11.92
	1.06		0.17		11.50
	1.00		0.16		10.10
	1.00		0.15		9.89
	0.89		0.15		9.48
	0.86		0.15		8.30
	0.85		0.15		8.84
	0.78		0.14		8.64
	0.69		0.14		7.82

B-11

# CONFIDENTIAL

**CONFIDENTIAL**

<u>Zone</u>	<u>Weight</u>	<u>Code</u>	<u>Zone</u>	<u>Weight</u>	<u>Grain</u>	<u>Zone</u>	<u>Weight</u>	<u>Code</u>
18	7.62		18	1.84		18	0.57	
	5.85			1.80			0.54	B
	5.70			1.80			0.49	
	5.58			1.73			0.46	
	5.42			1.75			0.44	
	5.18			1.64			0.43	B
	4.97			1.62			0.43	
	4.93			1.62			0.40	
	4.94			1.60			0.39	
	4.78			1.50			0.38	
	4.74			1.50			0.38	
	4.20			1.49			0.35	
	4.20			1.46			0.35	
	4.05			1.42			0.34	
	3.60			1.42			0.33	
	3.55			1.40			0.32	
	3.48			1.37			0.32	
	3.41			1.36			0.31	
	3.35			1.35			0.30	
	3.28			1.27			0.30	
	3.11			1.27			0.30	B
	2.94			1.25			0.25	
	2.89			1.25			0.21	
	2.63			1.25			0.20	
	2.55			1.11			0.19	
	2.50			1.10			0.19	
	2.64			1.09			0.19	
	2.45			1.06			0.18	
	2.38			1.06			0.17	
	2.37			1.05			0.15	
	2.34			1.05			0.15	
	2.26			1.02			0.15	
	2.22	B		1.02			0.15	
	2.15			1.02			0.14	
	2.07			0.99			0.12	
	2.02			0.97			0.12	
	2.02			0.87			0.11	
	2.00			0.80			0.10	
	2.00			0.75			0.10	
	2.03			0.69			0.09	
	1.97			0.69			0.09	
	1.95			0.67			0.09	
	1.92			0.66			0.08	
	1.92			0.65	B		0.08	
	1.89			0.64			0.07	
	1.88			0.63			0.07	
	1.88			0.62			0.07	
	1.85			0.61			0.07	
	1.85			0.61			0.07	
	1.84			0.58			0.06	

B-12

**CONFIDENTIAL**

# CONFIDENTIAL

<u>Zone</u>	<u>Weight</u>	<u>Code</u>	<u>Zone</u>	<u>Weight</u>	<u>Grain</u>	<u>Zone</u>	<u>Weight</u>	<u>Code</u>
18	0.06		19	0.39	B	19	0.10	B
	0.06			0.24	B		0.06	B
	0.05			0.30	B		0.06	B
	0.04			0.33	B		0.05	B
	0.03			0.30	B		0.05	B
	0.03			0.28	B		0.05	B
	0.03			0.35	B		0.03	B
	0.02			0.28	B		0.03	B
	0.02			0.25	B		0.02	B
	0.02			0.30	B		0.02	B
	0.60			0.22	B		0.03	B
	0.15			0.20	B		0.02	B
				0.35	B		0.01	B
Total	471.48			0.11	B		0.01	B
				0.14	B		0.01	B
19	83.06	B		0.22	B		16.10	B
	97.18	B		0.12	B		8.97	B
	76.20	B		0.19	B		5.97	B
	63.80	B		0.25	B		7.13	B
	45.74	B		0.16	B		6.55	B
	38.28	B		0.12	B		5.07	B
	34.18	B		0.13	B		5.25	B
	30.42	B		0.22	B		3.45	B
	31.80	B		0.15	B		3.63	B
	26.80	B		0.15	B		3.25	B
	16.85	B		0.24	B		3.00	B
	12.50	B		0.19	B		2.54	B
	8.14	B		0.14	B		1.35	B
	6.98	B		0.10	B		1.74	B
	4.89	B		0.19	B		2.02	B
	6.07	B		0.18	B		2.47	B
	3.21	B		0.07	B		1.65	B
	2.65	B		0.09	B		0.85	B
	1.94	B		0.12	B		1.00	B
	1.27	B		0.06	B		0.80	B
	0.82	B		0.08	B		0.76	B
	0.90	B		0.09	B		0.39	B
	0.85	B		0.13	B		0.38	B
	0.60	B		0.07	B		0.22	B
	0.65	B		0.10	B		0.21	B
	0.50	B		0.09	B		0.19	B
	0.44	B		0.12	B		0.14	B
	0.57	B		0.09	B		0.10	B
	0.67	B		0.10	B		0.07	B
	0.44	B		0.05	B		0.14	B
	0.34	B		0.09	B		0.12	B
	0.40	B		0.05	B		0.08	B
	0.47	B		0.12	B		0.15	B
	0.48	B		0.10	B		0.05	B
	0.30	B		0.07	B		0.05	B

B-13

# CONFIDENTIAL

# CONFIDENTIAL

<u>Zone</u>	<u>Weight</u>	<u>Zone</u>	<u>Weight</u>	<u>Code</u>
19	0.05	LN	13.67	F
	0.03		18.16	F
	0.02		12.97	F
	0.06		4.88	F
	0.03		4.53	F
			3.53	F
Total	695.45		4.10	F
18B	5.92		3.35	F
	3.00		3.53	F
	3.55		2.36	F
	3.52		1.21	F
	3.64		1.57	F
	2.10		0.75	F
	1.65	Total	74.61	
	1.74			
	1.57	2N	5507.00	F
	1.40		0.99	F
	1.82	Total	5507.99	
	1.16			
	1.72			
	1.37			
	0.83			
	0.85			
	0.52			
	0.30			
	0.35			
	0.30			
	0.18			
	0.20			
	0.12			
	0.30			
	0.04			
	0.16			
	0.25			
	0.15			
	0.18			
	0.14			
Total	39.03			
19B	11.29			
	10.30			
	2.09			
	1.50			
	0.84			
	0.08			
	0.08			
Total	26.18			

GRAND TOTAL

No. 1886

Weight Grains 14,374.12

Code: F - Fuze  
 B - Brass  
 NR - No Recovery



# CONFIDENTIAL

155-mm, XM378  
Round No. 2  
12 November 1959

<u>Zone</u>	<u>Weight</u>	<u>Code</u>	<u>Zone</u>	<u>Weight</u>	<u>Code</u>	<u>Zone</u>	<u>Weight</u>
1	5185.00	F	2	68.20	F	5	1.42
	180.00	F		51.20	F		1.64
	33.20	F		22.82	F		0.82
	22.90	F		17.86	F		0.50
	20.10	F		7.50	F		0.47
	12.60	F		8.09	F		0.24
	12.16	F		6.25	F		0.19
	10.37	F		3.15	F		0.14
	4.98	F		2.00	F		0.06
	4.73	F		1.10	F		0.07
	1.25	F		1.42	F		0.05
	1.30	F		1.58	F	Total	185.74
	1.07	F		1.45	F		
	1.08	F		1.74	F	6	111.00
	0.47	F		0.88	F		96.80
	0.65	F		0.50	F		25.36
	0.38	F		1.00	F		12.50
	0.70	F		0.92	F		11.79
	0.40	F		0.75	F		3.03
	0.39	F		0.50	F		2.37
	0.35	F		0.30	F		2.92
	0.40	F		0.25	F		0.70
	0.30	F		0.34	F		0.43
	0.42	F		0.30	F		0.20
	0.30	F		0.14	F		0.13
	0.19	F		0.10	F		0.20
	0.18	F		0.10	F		0.05
	0.14	F		0.10	F	Total	267.48
	0.14	F		0.12	F		
	0.16	F		0.15	F	7	9.00
	0.12	F		0.10	F		6.35
	0.13	F		0.05	F		5.15
	0.23	F	Total	1173.96			1.64
	0.20	F					1.50
	0.14	F	3	NR			0.84
	0.10	F					0.58
	0.10	F	4	0.22			0.40
	0.09	F		0.17			0.52
	0.07	F		0.18			0.46
	0.08	F		0.09	F		0.50
	0.06	F					0.29
Total	5497.63		Total	0.66			0.24
							0.10
2	703.00	F	5	176.00			0.14
	169.00	F		2.78			0.05
	101.00	F		1.36			0.07

B15  
**CONFIDENTIAL**

**CONFIDENTIAL**

<u>Zone</u>	<u>Weight</u>	<u>Zone</u>	<u>Weight</u>	<u>Zone</u>	<u>Weight</u>
7	0.04	9	4.52	9	0.15
<b>Total</b>	<b>27.87</b>		3.62		0.18
			4.50		0.11
8	3.69		3.10		0.18
	4.00		3.55		0.10
	2.70		3.07		0.17
	3.20		3.54		0.08
	3.24		2.36		0.12
	1.87		3.12		0.05
	2.12		1.78		0.05
	1.32		1.80		0.04
	1.28		1.40		0.07
	1.08		1.55		0.07
	1.11		1.18		0.05
	0.96		1.43		0.04
	1.17		1.54		0.02
	0.60		1.09	<b>Total</b>	<b>234.55</b>
	0.55		1.73		
	0.34		1.87	10	41.00
	0.22		1.48		36.66
	0.32		0.95		30.26
	0.19		1.28		31.84
	0.14		1.25		26.07
	0.10		1.30		29.05
	0.12		1.10		24.58
	0.24		0.66		26.40
	0.10		1.06		21.84
	0.08		0.72		17.43
	0.04		0.65		21.27
	0.04		1.17		20.67
	0.04		0.69		14.75
	0.04		0.60		16.24
<b>Total</b>	<b>30.91</b>		0.45		14.15
			0.66		15.80
9	28.12		0.31		15.62
	19.18		0.65		13.63
	15.32		0.32		14.70
	15.00		0.46		16.40
	12.90		0.47		17.80
	13.08		0.26		15.26
	9.70		0.55		12.53
	9.40		0.44		15.60
	6.67		0.30		14.18
	7.40		0.40		13.04
	6.80		0.25		12.74
	4.86		0.29		12.34
	5.43		0.35		12.46
	4.51		0.14		12.56
	4.92		0.15		8.45
	3.28		0.25		
			0.14		

# CONFIDENTIAL

<u>Zone</u>	<u>Weight</u>	<u>Zone</u>	<u>Weight</u>	<u>Zone</u>	<u>Weight</u>
10	9.60	10	4.21	10	0.98
	13.15		3.35		1.10
	10.32		2.42		1.20
	8.12		2.90		1.22
	10.62		2.40		1.55
	9.72		3.10		1.31
	7.83		3.35		0.70
	8.57		3.25		0.72
	6.05		2.52		1.16
	8.13		4.25		1.14
	8.24		2.10		0.95
	10.50		3.32		1.10
	8.35		2.07		0.89
	8.62		2.68		0.83
	7.60		3.29		0.64
	8.07		2.97		0.82
	5.50		2.26		0.48
	7.60		2.26		0.74
	7.40		1.69		0.68
	8.81		3.05		0.41
	8.85		1.60		0.50
	6.54		2.82		0.62
	7.24		2.56		0.40
	7.36		2.53		0.42
	4.80		1.89		0.67
	5.80		1.79		0.44
	4.72		1.60		0.69
	5.54		1.90		0.58
	5.39		2.06		0.30
	6.53		1.76		0.49
	5.84		1.74		0.27
	5.05		3.10		0.49
	6.64		1.75		0.48
	4.21		1.75		0.32
	4.74		1.58		0.34
	5.68		1.33		0.45
	5.68		1.33		0.35
	4.00		1.75		0.50
	4.32		1.70		0.55
	4.28		2.05		0.34
	3.99		1.35		0.32
	5.43		1.45		0.44
	3.80		1.56		0.50
	3.83		1.76		0.32
	4.00		1.27		0.30
	2.71		0.98		0.40
	3.15		1.10		0.24
	4.00		1.05		0.29
	3.30		0.95		0.27
	3.22		0.96		0.26

B-17

# CONFIDENTIAL

**CONFIDENTIAL**

<u>Zone</u>	<u>Weight</u>	<u>Zone</u>	<u>Weight</u>	<u>Zone</u>	<u>Weight</u>
10	0.45	11	37.62	11	14.73
	0.24		32.84		13.05
	0.45		33.00		17.10
	0.32		42.28		15.00
	0.13		38.40		11.65
	0.30		34.00		15.50
	0.25		43.12		12.95
	0.14		44.40		13.34
	0.20		34.00		15.58
	0.14		32.52		16.54
	0.15		35.80		14.47
	0.13		40.12		15.32
	0.20		34.00		15.55
	0.20		31.40		11.39
	0.14		29.24		12.90
	0.10		28.98		15.93
	0.10		26.70		17.35
	0.13		26.80		12.60
	0.07		26.30		18.00
	0.05		23.56		12.66
	0.05		26.64		19.72
	0.10		26.94		15.94
	0.10		27.40		11.46
	0.09		24.35		16.49
	0.02		26.07		13.67
	0.08		28.90		13.68
	0.06		22.14		10.10
	0.05		24.08		11.95
	0.03		24.50		10.49
	0.03		26.40		15.21
	0.01		19.60		22.40
	0.07		16.10		14.77
	0.02		23.90		16.82
			21.30		13.10
			21.87		11.90
			22.79		12.32
			23.70		11.35
			18.10		13.55
			17.39		12.00
			18.73		13.06
			18.65		10.12
			17.42		12.64
			22.65		13.23
			15.87		12.17
			15.25		7.88
			13.56		9.89
			16.45		9.85
			17.42		9.74
			16.65		8.33
			16.14		9.50
Total	1062.98				
11	74.04				
	55.68				
	61.42				
	71.00				
	66.00				
	73.06				
	51.72				
	55.00				
	51.28				
	64.24				
	53.40				
	43.90				
	37.22				
	37.00				

# CONFIDENTIAL

<u>Zone</u>	<u>Weight</u>	<u>Zone</u>	<u>Weight</u>	<u>Zone</u>	<u>Weight</u>
11	7.78	11	5.22	11	3.35
	8.33		4.32		3.18
	10.15		6.35		3.96
	9.04		6.09		3.13
	8.52		5.60		3.59
	9.63		4.93		3.35
	10.43		7.30		3.12
	7.50		6.32		3.34
	9.63		6.25		3.18
	8.65		4.90		4.16
	8.88		5.08		2.78
	10.70		5.21		3.20
	8.04		6.25		2.60
	8.33		5.47		3.30
	6.60		6.03		2.40
	9.17		4.85		2.03
	8.67		6.33		3.36
	7.30		5.83		2.55
	9.60		3.50		3.80
	8.64		5.37		2.35
	9.40		4.94		2.80
	7.60		4.98		2.29
	8.00		5.06		2.60
	11.90		4.12		3.12
	7.04		4.07		2.35
	7.62		5.09		3.22
	6.66		4.70		3.37
	9.76		5.05		3.41
	8.50		4.41		2.26
	9.78		3.60		2.00
	11.00		4.22		2.25
	8.78		4.36		2.65
	6.83		3.46		2.65
	6.05		5.24		2.10
	6.36		3.29		1.86
	5.80		4.67		1.95
	6.87		4.62		1.94
	8.56		4.34		2.43
	7.97		4.60		2.09
	7.24		4.72		2.52
	6.30		4.60		2.66
	7.39		4.30		3.04
	6.80		4.28		2.64
	7.28		3.51		1.94
	7.12		4.37		2.35
	7.44		4.14		2.00
	5.25		4.25		2.54
	6.20		4.25		2.10
	6.84		4.72		2.00
	4.72		4.28		2.55

B-19

# CONFIDENTIAL

# CONFIDENTIAL

<u>Zone</u>	<u>Weight</u>	<u>Zone</u>	<u>Weight</u>	<u>Zone</u>	<u>Weight</u>
11	2.75	11	0.86	11	0.80
	2.00		1.23		0.64
	2.56		1.45		0.44
	1.70		1.57		0.44
	2.16		0.90		0.55
	2.46		0.98		0.52
	1.46		1.30		0.76
	2.37		0.80		0.60
	2.56		1.18		0.52
	2.20		0.95		0.50
	1.75		1.25		0.66
	1.59		1.50		0.40
	1.85		1.24		0.43
	1.76		1.40		0.65
	1.40		1.05		0.55
	2.36		0.82		0.66
	1.64		1.06		0.37
	1.60		0.80		0.52
	1.90		0.90		0.52
	2.15		0.95		0.55
	1.70		0.75		0.40
	1.85		1.05		0.55
	1.73		0.88		0.65
	2.11		1.04		0.56
	1.66		0.80		0.56
	1.81		1.21		0.45
	1.75		0.85		0.42
	1.80		1.00		0.38
	1.54		1.18		0.32
	1.78		0.82		0.51
	1.41		0.85		0.35
	1.53		1.07		0.25
	1.49		0.84		0.45
	1.40		0.61		0.24
	1.30		0.67		0.34
	1.25		0.40		0.28
	1.42		0.70		0.37
	1.35		0.50		0.30
	1.30		0.40		0.31
	1.60		0.94		0.30
	1.76		0.65		0.24
	1.42		0.60		0.21
	1.10		0.77		0.23
	2.20		0.84		0.18
	1.55		0.95		0.33
	1.70		0.60		0.21
	1.40		0.58		0.19
	1.41		0.78		0.27
	0.93		0.65		0.20
	1.15		0.60		0.25

B-20

# CONFIDENTIAL

# CONFIDENTIAL

<u>Zone</u>	<u>Weight</u>	<u>Zone</u>	<u>Weight</u>	<u>Zone</u>	<u>Weight</u>
11	0.19	11	0.01	12	1.24
	0.30		0.05		1.78
	0.30		0.06		1.29
	0.13		0.02		1.44
	0.15		0.02		1.08
	0.14		0.02		0.83
	0.15		0.05		0.75
	0.10		0.05		0.75
	0.21		0.05		0.42
	0.18		0.05		0.76
	0.12		0.05		0.83
	0.15		0.05		0.80
	0.16		0.05		0.64
	0.12		0.05		0.34
	0.12		0.05		0.34
	0.13		0.05		0.40
	0.12		0.01		0.07
	0.14		0.01		
	0.10		0.01	Total	107.59
	0.14		0.01		
	0.10		0.01	13	34.00
	0.12		0.01		29.32
	0.08		0.01		19.25
	0.07		0.01		16.05
	0.07		0.01		19.66
	0.11				13.25
	0.08	Total	3718.05		13.05
	0.04				12.44
	0.08	12	8.72		9.35
	0.08		7.56		9.47
	0.11		6.72		8.05
	0.06		9.60		7.02
	0.09		6.53		6.60
	0.05		5.21		8.15
	0.06		5.30		8.57
	0.08		5.02		6.22
	0.05		3.35		6.70
	0.02		3.86		7.28
	0.03		4.35		6.45
	0.09		2.65		7.78
	0.06		2.61		5.00
	0.04		3.91		8.10
	0.05		2.30		5.66
	0.04		2.23		5.42
	0.05		2.36		4.25
	0.05		2.40		3.66
	0.02		2.72		3.60
	0.05		1.69		4.27
	0.07		2.15		4.28
	0.02		2.59		3.28

B-21

# CONFIDENTIAL

# CONFIDENTIAL

<u>Zone</u>	<u>Weight</u>	<u>Zone</u>	<u>Weight</u>	<u>Zone</u>	<u>Weight</u>
13	2.34	13	0.04	16	8.29
	3.38		0.04		9.40
	3.85				6.60
	3.28	Total	355.09		4.89
	4.17				1.80
	2.82	14	13.76		1.34
	3.06		13.12		0.90
	2.50		7.81		0.76
	2.00		7.23		0.64
	1.73		4.00		0.41
	1.64		4.22		0.50
	3.00		4.40		0.44
	1.74		4.10		0.23
	1.00		3.40		
	1.28		1.93	Total	36.20
	1.55		2.25		
	1.12		1.70	17	34.00
	1.30		1.37		32.42
	1.11		0.74		24.93
	0.80		0.79		18.30
	1.16		0.69		18.15
	1.00		0.88		9.80
	0.80		0.60		13.23
	1.10		0.63		11.00
	1.50		0.33		8.98
	0.66		0.30		8.62
	0.88		0.34		7.89
	0.75		0.37		7.15
	0.64		0.40		6.65
	0.85		0.29		5.38
	0.80		0.24		4.05
	0.42		0.25		4.35
	0.47		0.14		3.60
	0.52				3.89
	0.40	Total	76.28		2.72
	0.60				1.70
	0.32	15	3.90		1.87
	0.27		1.70		2.20
	0.30		1.30		3.10
	0.41		1.45		2.36
	0.22		1.37		3.12
	0.13		1.06		1.59
	0.15		1.34		1.35
	0.16		1.46		1.64
	0.30		0.72		1.96
	0.13				1.30
	0.11	Total	14.30		1.85
	0.11				1.50



**CONFIDENTIAL**

<u>Zone</u>	<u>Weight</u>	<u>Zone</u>	<u>Weight</u>	<u>Zone</u>	<u>Weight</u>
17	1.29	17	0.40	18	13.66
	1.82		0.33		14.90
	1.51		0.35		12.52
	1.23		0.42		8.59
	1.40		0.31		10.97
	1.12		0.26		8.79
	1.00		0.22		10.78
	1.14		0.20		6.08
	0.82		0.19		5.92
	0.91		0.20		6.05
	0.87		0.18		5.41
	1.21		0.23		5.93
	0.70		0.20		5.52
	0.78		0.20		3.78
	1.19		0.14		4.70
	0.60		0.30		5.21
	0.65		0.14		5.37
	0.70		0.30		4.20
	0.68		0.26		4.05
	0.56		0.16		4.83
	0.60		0.13		4.39
	0.75		0.12		5.14
	0.67		0.19		3.36
	0.55		0.15		4.30
	0.62		0.23		2.80
	0.44		0.14		3.74
	0.48		0.20		3.20
	0.70		0.10		2.70
	0.54		0.16		3.52
	0.49		0.16		2.59
	0.73		0.07		2.40
	0.48		0.15		3.38
	0.39		0.10		2.92
	0.36		0.08		2.75
	0.27		0.10		2.13
	0.59		0.09		2.51
	0.55		0.09		3.16
	0.40		0.05		3.10
	0.40		0.05		3.35
	0.29		0.02		2.41
	0.50				2.85
	0.35	Total	292.52		1.60
	0.48				2.69
	0.39	18	19.05		2.42
	0.38		23.00		2.30
	0.44		16.60		2.12
	0.40		13.38		1.80
	0.40		14.10		2.37
	0.43		11.69		2.43
	0.25		12.92		2.13

B-23

**CONFIDENTIAL**

# CONFIDENTIAL

<u>Zone</u>	<u>Weight</u>	<u>Zone</u>	<u>Weight</u>	<u>Zone</u>	<u>Weight</u>	<u>Code</u>
18	1.80	18	0.88	18	0.34	
	1.56		0.91		0.30	
	1.50		0.80		0.26	
	2.00		0.95		0.29	
	2.31		0.92		0.22	
	1.84		0.95		0.25	
	1.66		0.95		0.34	
	1.49		0.70		0.27	
	1.98		0.96		0.35	
	1.86		0.70		0.25	
	1.48		0.94		0.20	
	2.17		0.60		0.43	B
	1.79		0.58		0.35	B
	2.10		0.82		0.55	B
	2.08		0.62		0.37	B
	1.82		0.78		0.15	
	1.30		0.86		0.30	
	1.85		0.77		0.30	
	1.26		0.50		0.27	
	1.92		0.68		0.20	
	1.22		0.54		0.24	
	1.42		0.52		0.24	
	1.45		0.54		0.30	
	2.06		0.50		0.20	
	1.26		0.47		0.23	
	1.49		0.35		0.25	
	1.22		0.54		0.24	
	1.18		0.50		0.22	
	0.95		0.54		0.22	
	1.20		0.45		0.25	
	1.00		0.53		0.24	
	1.20		0.42		0.16	
	1.09		0.45		0.15	
	1.08		0.38		0.19	
	1.30		0.50		0.16	
	0.94		0.50		0.16	
	0.78		0.35		0.18	
	0.72		0.47		0.17	
	0.82		0.42		0.26	
	0.92		0.40		0.14	
	0.82		0.55		0.19	
	0.82		0.40		0.14	
	1.05		0.42		0.13	
	0.85		0.31		0.16	
	1.63		0.46		0.09	
	1.05		0.50		0.10	
	1.07		0.37		0.13	
	1.22		0.38		0.15	
	0.73		0.38		0.10	
	0.74		0.34		0.10	

B-24

# CONFIDENTIAL

# CONFIDENTIAL

<u>Zone</u>	<u>Weight</u>	<u>Zone</u>	<u>Weight</u>	<u>Code</u>	<u>Zone</u>	<u>Weight</u>	<u>Code</u>
18	0.09	18	0.01		19	1.80	
	0.10		0.01			1.72	B
	0.10					1.70	B
	0.05	Total	456.77			1.65	B
	0.07					2.00	B
	0.10	19	249.00	B		1.40	
	0.05		37.80	B		1.26	B
	0.06		26.75	B		1.30	
	0.05		27.33	B		1.75	
	0.11		15.80			1.34	B
	0.05		14.85	B		1.42	B
	0.07		11.37	B		1.50	B
	0.05		10.40			1.25	B
	0.07		12.42	B		1.25	B
	0.07		12.75	B		1.34	
	0.05		9.32	B		1.10	
	0.09		7.57			1.20	
	0.05		7.29	B		0.80	
	0.04		8.10	B		1.10	B
	0.09		7.64			0.80	B
	0.04		6.55	B		0.75	
	0.04		5.43	B		0.87	B
	0.04		5.22	B		0.67	B
	0.05		4.28	B		0.45	
	0.04		4.18			0.68	B
	0.05		4.44			0.64	B
	0.05		3.75	B		0.80	B
	0.06		3.70			0.68	B
	0.05		3.88			0.72	
	0.05		3.32			0.53	B
	0.03		3.00			0.54	
	0.03		2.97	B		0.54	
	0.03		3.20	B		0.44	
	0.05		4.42	B		0.36	
	0.02		2.80	B		0.57	B
	0.03		3.15	B		0.47	B
	0.02		2.75			0.51	B
	0.02		2.40	B		0.47	B
	0.02		2.22	B		0.40	B
	0.02		1.83			0.37	B
	0.02		2.50	B		0.36	
	0.02		2.46	B		0.52	B
	0.02		2.50	B		0.44	B
	0.02		2.62			0.50	B
	0.02		2.04	B		0.38	B
	0.02		2.02			0.60	B
	0.01		1.95	B		0.33	B
	0.01		1.88			0.32	
	0.01		1.75			0.36	B
	0.01		1.97	B		0.40	B

B-25

# CONFIDENTIAL

# CONFIDENTIAL

<u>Zone</u>	<u>Weight</u>	<u>Code</u>	<u>Zone</u>	<u>Weight</u>	<u>Grain</u>	<u>Zone</u>	<u>Weight</u>	<u>Code</u>
19	0.41	B	19	0.22	B	19B	2.65	
	0.40	B		0.10	B		2.58	B
	0.55	B		0.10	B		2.00	
	0.40	B		0.08	B		1.44	
	0.45	B		0.13	B		1.63	B
	0.35	B		0.10	B		1.45	B
	0.32	B		0.10	B		1.30	
	0.42	B		0.09	B		1.40	B
	0.40			0.09	B		1.22	B
	0.26			0.07	B		1.10	
	0.37	B		0.10	B		1.40	
	0.39	B		0.10	B		1.22	
	0.40	B		0.07	B		0.72	
	0.30	B		0.10			0.80	
	0.34	B		0.06			0.75	
	0.30	B		0.07			0.57	B
	0.28	B		0.05			0.75	B
	0.21	B		0.06			0.52	B
	0.23			0.05			0.47	
	0.30			0.06	B		0.43	
	0.18			0.05	B		0.33	
	0.27	B		0.04	B		0.44	B
	0.26	B		0.02	B		0.36	
	0.23	B		0.07	B		0.30	
	0.12	B		0.05	B		0.25	
	0.36			0.04	B		0.24	
	0.24			0.04	B		0.25	
	0.18			0.03	B		0.20	
	0.15			0.05	B		0.25	
	0.17	B		0.05	B		0.16	
	0.25	B		0.02	B		0.26	B
	0.17	B		0.02	B		0.27	B
	0.19	B		0.02			0.24	B
	0.21	B		0.02			0.29	B
	0.25	B		0.02			0.24	B
	0.24	B					0.20	B
	0.20	B	Total	611.97			0.23	B
	0.19	B					0.17	B
	0.18	B	19B	28.77	B		0.22	B
	0.17			17.73			0.25	B
	0.14			8.55	B		0.22	B
	0.21			4.60			0.24	B
	0.15	B		6.27			0.19	B
	0.18	B		3.60			0.21	B
	0.15	B		3.45	B		0.19	B
	0.12	B		2.94			0.19	B
	0.12			3.28			0.12	B
	0.15			2.86			0.14	
	0.10			2.64			0.20	
	0.10			3.02			0.19	

B-26

# CONFIDENTIAL

# CONFIDENTIAL

<u>Zone</u>	<u>Weight</u>	<u>Code</u>	<u>Zone</u>	<u>Weight</u>	<u>Code</u>	<u>Zone</u>	<u>Weight</u>	<u>Code</u>
19B	0.14		18B	2.37		1N	5.24	F
	0.16			2.23			1.58	F
	0.14			1.52			1.27	F
	0.13			1.40		Total	113.30	
	0.13	B		1.26				
	0.17	B		1.42		2N	118.00	F
	0.18	B		1.45	B		19.72	F
	0.12	B		1.51	B		6.95	F
	0.10	B		1.69		Total	144.67	
	0.10			1.36				
	0.08			0.04				
	0.07			0.05				
	0.02			0.04				
	0.02			0.95				
	0.10	B		0.92				
	0.08	B		1.06				
	0.07	B		0.67				
	0.09	B		0.82				
	0.06	B		0.72	B			
	0.05	B		0.47	B			
	0.05	B		0.45	B			
	0.05	B		0.50	B			
	0.06	B		0.41	B			
	0.05	B		0.33				
	0.08	B		0.49				
	0.05	B		0.30				
	0.06	B		0.25				
	0.03	B		0.23				
	0.05	B		0.25				
	0.05	B		0.39				
	0.03	B		0.35				
	0.05	B		0.22				
	0.02	B		0.33				
	0.02	B		0.30				
	0.02	B		0.29				
	0.02	B		0.18				
	0.02	B		0.11				
	0.02	B		0.15				
	0.02	B		0.20	B			
	0.02	B		0.15				
	0.02	B		0.09				
	0.02	B		0.06				
	0.02	B		0.05				
	0.02	B		0.11	B			
	0.02	B		0.03	B			
	0.02	B		0.03				
Total	121.89		Total	62.84				
18B	6.87		1N	93.42	F			
	4.03			11.79	F			
	4.15							
	5.62							
	3.63							
	2.85							
	2.27							
	2.45							
	2.80							

GRAND TOTAL

No. 1833

Weight Grains 14,593.25

Code:

- F - Fuze
- B - Brass
- NR - No Recovery

B-27

# CONFIDENTIAL

# CONFIDENTIAL

115-mm, XM378  
Round No. 3  
20 November 1959

<u>Zone</u>	<u>Weight</u>	<u>Code</u>	<u>Zone</u>	<u>Weight</u>	<u>Code</u>	<u>Zone</u>	<u>Weight</u>
1N	5761.00	F	1	0.15	F	7	0.20
	24.20	F		0.13	F		
	21.64	F		0.10	F	Total	4.88
	15.07	F		0.09	F		
	10.13	F	Total	54.42		8	24.16
	2.09	F					4.47
	1.53	F					4.37
	1.45	F	2	835.00	F		3.46
	1.15	F		267.00	F		2.21
	1.05	F		103.00	F		1.92
	0.89	F		25.76	F		1.89
	0.82	F		21.45	F		1.70
	0.55	F		15.90	F		1.65
	0.55	F		8.70	F		1.62
	0.54	F		3.30	F		1.35
	0.22	F		2.26	F		1.09
	0.13	F	Total	1282.37			0.92
	0.02	F					0.90
Total	5843.03		3	54.50	F		0.90
				38.32	F		0.90
				4.85	F		0.77
2N	62.82	F	Total	97.67			0.74
	10.13	F					0.64
	5.73	F	4	NR			0.60
	4.70	F					0.54
	0.80	F	5	2.41			0.52
	0.40	F		2.11			0.40
	0.24	F		0.72			0.35
Total	84.82			0.60			0.18
			Total	5.84			0.14
1	24.72	F					0.12
	5.42	F	6	10.80			0.12
	4.72	F		5.18			0.10
	4.40	F		2.53			0.09
	3.67	F		0.60			0.05
	2.40	F		0.42			0.03
	1.98	F		0.28			
	1.50	F	Total	19.81		Total	58.90
	1.30	F				9	19.12
	1.09	F					17.36
	1.03	F					14.10
	0.58	F					13.29
	0.38	F	7	1.80			10.67
	0.31	F		1.69			9.98
	0.23	F		0.60			9.80
	0.22	F		0.59			7.43

B-28

# CONFIDENTIAL

**CONFIDENTIAL**

<u>Zone</u>	<u>Weight</u>	<u>Zone</u>	<u>Weight</u>	<u>Zone</u>	<u>Weight</u>
9	6.46	9	0.64	10	13.13
	6.28		0.62		13.11
	6.22		0.54		12.60
	6.20		0.50		12.31
	6.15		0.44		12.30
	6.10		0.43		12.13
	5.40		0.40		11.95
	5.39		0.37		11.49
	5.30		0.35		10.82
	4.91		0.34		10.60
	4.90		0.30		9.30
	4.62		0.28		9.18
	3.82		0.25		9.00
	3.49		0.24		9.00
	3.37		0.23		8.95
	3.37		0.22		8.66
	3.08		0.21		8.28
	3.04		0.19		8.22
	2.95		0.18		8.15
	2.95		0.18		7.92
	2.92		0.11		7.83
	2.82		0.11		7.82
	2.80		0.11		7.57
	2.80		0.11		7.55
	2.72		0.10		7.38
	2.35		0.10		7.30
	2.30		0.09		7.02
	2.30		0.08		6.80
	2.27		0.07		6.52
	2.00		0.04		6.45
	1.85		0.04		6.45
	1.53		0.03		6.05
	1.48		0.02		5.98
	1.38		0.02		5.68
	1.12				5.63
	1.08	Total	248.54		5.60
	0.97				5.20
	0.96	10	22.06		5.18
	0.94		20.70		5.15
	0.93		19.41		5.03
	0.85		19.25		5.00
	0.80		17.59		4.95
	0.80		15.85		4.92
	0.80		15.55		4.87
	0.76		15.19		4.77
	0.68		15.03		4.72
	0.68		14.80		4.66
	0.67		14.26		4.46
	0.65		13.60		4.46
	0.64		13.35		4.41

# CONFIDENTIAL

<u>Zone</u>	<u>Weight</u>	<u>Zone</u>	<u>Weight</u>	<u>Zone</u>	<u>Weight</u>
10	4.17	10	1.96	10	0.95
	4.12		1.94		0.94
	3.98		1.93		0.91
	3.79		1.90		0.89
	3.74		1.90		0.89
	3.66		1.90		0.89
	3.63		1.86		0.88
	3.60		1.84		0.87
	3.60		1.79		0.87
	3.59		1.77		0.85
	3.55		1.72		0.85
	3.54		1.70		0.84
	3.52		1.69		0.82
	3.52		1.64		0.80
	3.46		1.60		0.79
	3.37		1.60		0.76
	3.25		1.54		0.75
	3.15		1.48		0.75
	3.14		1.46		0.73
	3.12		1.46		0.72
	3.11		1.45		0.72
	3.10		1.45		0.72
	3.06		1.40		0.69
	3.04		1.39		0.68
	3.03		1.32		0.68
	2.96		1.31		0.65
	2.92		1.30		0.65
	2.90		1.26		0.63
	2.89		1.26		0.62
	2.80		1.25		0.62
	2.75		1.20		0.62
	2.70		1.18		0.60
	2.70		1.12		0.60
	2.67		1.10		0.58
	2.66		1.10		0.58
	2.62		1.10		0.54
	2.61		1.09		0.54
	2.57		1.06		0.53
	2.46		1.06		0.52
	2.42		1.05		0.51
	2.42		1.04		0.50
	2.36		1.02		0.50
	2.30		1.01		0.48
	2.30		1.73		0.48
	2.21		1.33		0.45
	2.17		1.05		0.45
	2.16		0.98		0.44
	2.15		0.98		0.43
	2.02		0.96		0.42
	2.00		0.95		0.42

B-80

# CONFIDENTIAL



# CONFIDENTIAL

<u>Zone</u>	<u>Weight</u>	<u>Zone</u>	<u>Weight</u>	<u>Zone</u>	<u>Weight</u>
10	0.40	10	0.14	11	89.62
	0.40		0.14		81.62
	0.40		0.14		75.20
	0.40		0.13		73.20
	0.40		0.13		61.88
	0.38		0.13		59.20
	0.38		0.13		58.20
	0.36		0.12		57.60
	0.35		0.12		54.62
	0.34		0.11		52.80
	0.34		0.11		52.78
	0.34		0.10		52.20
	0.34		0.10		48.26
	0.31		0.10		47.42
	0.30		0.10		44.20
	0.30		0.10		43.40
	0.29		0.10		40.72
	0.29		0.09		39.44
	0.29		0.09		39.00
	0.28		0.09		39.00
	0.28		0.08		36.60
	0.27		0.08		32.80
	0.25		0.08		32.20
	0.25		0.08		31.92
	0.25		0.07		31.80
	0.25		0.06		30.32
	0.24		0.06		29.49
	0.24		0.06		27.87
	0.24		0.06		27.75
	0.23		0.05		27.70
	0.22		0.05		27.43
	0.22		0.05		26.82
	0.22		0.05		26.15
	0.21		0.05		26.00
	0.20		0.04		25.99
	0.20		0.04		25.68
	0.19		0.04		25.62
	0.19		0.04		24.42
	0.18		0.04		24.25
	0.17		0.04		23.80
	0.17		0.03		23.31
	0.17		0.03		23.15
	0.17		0.03		22.78
	0.17		0.03		22.50
	0.16		0.03		21.62
	0.16		0.02		21.54
	0.15		0.02		21.49
	0.15		0.01		21.10
	0.15		0.01		20.00
	0.14				19.98
	0.14				19.30
		Total	869.21		

B-31

# CONFIDENTIAL

**CONFIDENTIAL**

<u>Zone</u>	<u>Weight</u>	<u>Zone</u>	<u>Weight</u>	<u>Zone</u>	<u>Weight</u>
11	18.97	11	10.65	11	6.67
	18.50		10.62		6.65
	18.22		10.57		6.64
	18.12		10.52		6.59
	17.85		10.50		6.54
	17.60		10.47		6.45
	17.46		10.42		6.33
	17.34		10.40		6.33
	17.29		10.32		6.32
	17.28		10.22		6.16
	16.60		10.20		6.13
	16.60		10.13		6.08
	16.58		10.08		6.02
	16.50		9.88		6.00
	16.46		9.75		5.92
	16.45		9.56		5.90
	16.45		9.50		5.83
	16.10		9.49		5.82
	15.70		9.38		5.76
	15.48		9.25		5.70
	15.15		9.25		5.70
	15.10		9.20		5.68
	14.77		9.18		5.65
	14.70		8.89		5.63
	14.38		8.80		5.61
	14.32		8.75		5.54
	14.20		8.65		5.47
	14.06		8.65		5.42
	13.87		8.52		5.42
	13.71		8.34		5.38
	13.70		8.23		5.32
	13.44		7.43		5.23
	13.31		7.32		5.22
	13.03		7.25		5.22
	13.00		7.22		5.22
	12.70		7.20		5.20
	12.44		7.20		5.14
	12.17		7.10		5.12
	11.97		7.10		5.10
	11.82		7.06		5.06
	11.63		7.00		5.06
	11.61		6.93		5.00
	11.46		6.92		4.98
	11.08		6.85		4.95
	11.08		6.84		4.87
	10.95		6.83		4.87
	10.81		6.79		4.82
	10.79		6.79		4.80
	10.72		6.75		4.80
	10.70		6.75		4.80

**CONFIDENTIAL**

<u>Zone</u>	<u>Weight</u>	<u>Zone</u>	<u>Weight</u>	<u>Zone</u>	<u>Weight</u>
11	4.74	11	3.36	11	2.15
	4.70		3.32		2.10
	4.70		3.28		2.10
	4.67		3.24		2.07
	4.63		3.22		2.06
	4.57		3.20		2.05
	4.55		3.15		2.02
	4.55		3.14		2.00
	4.50		3.12		2.00
	4.49		3.04		2.00
	4.48		3.02		2.20
	4.46		3.02		2.20
	4.45		2.92		1.97
	4.44		2.89		1.96
	4.44		2.89		1.96
	4.40		2.85		1.95
	4.38		2.84		1.93
	4.35		2.81		1.91
	4.17		2.80		1.90
	4.13		2.74		1.90
	4.11		2.73		1.90
	4.10		2.72		1.86
	4.02		2.70		1.86
	4.02		2.70		1.85
	4.00		2.70		1.84
	4.00		2.68		1.83
	4.00		2.64		1.82
	3.95		2.64		1.80
	3.94		2.60		1.78
	3.78		2.58		1.72
	3.75		2.57		1.72
	3.74		2.55		1.71
	3.73		2.50		1.70
	3.72		2.50		1.69
	3.71		2.46		1.68
	3.71		2.46		1.68
	3.70		2.45		1.66
	3.68		2.45		1.60
	3.68		2.44		1.55
	3.61		2.44		1.54
	3.61		2.43		1.53
	3.60		2.42		1.50
	3.60		2.38		1.50
	3.54		2.34		1.50
	3.51		2.32		1.50
	3.51		2.29		1.50
	3.49		2.25		1.49
	3.46		2.25		1.49
	3.40		2.22		1.46
	3.37		2.21		1.45
			2.18		1.45

**CONFIDENTIAL**

<u>Zone</u>	<u>Weight</u>	<u>Zone</u>	<u>Weight</u>	<u>Zone</u>	<u>Weight</u>
11	1.45	11	0.90	11	0.55
	1.45		0.88		0.52
	1.43		0.86		0.52
	1.42		0.85		0.52
	1.40		0.85		0.51
	1.40		0.83		0.50
	1.39		0.82		0.50
	1.39		0.82		0.50
	1.34		0.80		0.49
	1.34		0.80		0.49
	1.32		0.79		0.49
	1.31		0.78		0.48
	1.30		0.78		0.48
	1.29		0.77		0.47
	1.27		0.77		0.47
	1.26		0.75		0.47
	1.25		0.74		0.46
	1.24		0.73		0.46
	1.19		0.73		0.46
	1.18		0.72		0.46
	1.17		0.72		0.45
	1.15		0.70		0.45
	1.15		0.70		0.45
	1.13		0.70		0.45
	1.12		0.70		0.44
	1.11		0.70		0.44
	1.10		0.69		0.43
	1.10		0.69		0.43
	1.10		0.68		0.42
	1.09		0.66		0.42
	1.09		0.65		0.42
	1.09		0.65		0.40
	1.05		0.65		0.40
	1.05		0.65		0.40
	1.03		0.64		0.39
	1.02		0.64		0.39
	1.02		0.63		0.38
	1.00		0.61		0.37
	0.98		0.60		0.35
	0.98		0.60		0.35
	0.98		0.60		0.34
	0.95		0.59		0.34
	0.95		0.59		0.34
	0.95		0.58		0.34
	0.94		0.58		0.34
	0.93		0.58		0.34
	0.92		0.56		0.33
	0.92		0.55		0.33
	0.90		0.55		0.32
	0.90		0.55		0.32

B-34

**CONFIDENTIAL**

# CONFIDENTIAL

<u>Zone</u>	<u>Weight</u>	<u>Zone</u>	<u>Weight</u>	<u>Zone</u>	<u>Weight</u>
11	0.32	11	0.15	11	0.07
	0.31		0.15		0.07
	0.30		0.15		0.07
	0.30		0.15		0.07
	0.30		0.15		0.07
	0.30		0.15		0.06
	0.29		0.15		0.06
	0.29		0.15		0.06
	0.29		0.15		0.06
	0.28		0.15		0.06
	0.27		0.15		0.06
	0.26		0.15		0.05
	0.26		0.15		0.05
	0.25		0.15		0.05
	0.25		0.14		0.05
	0.25		0.14		0.05
	0.25		0.14		0.05
	0.25		0.14		0.05
	0.25		0.14		0.05
	0.25		0.14		0.05
	0.25		0.14		0.05
	0.25		0.14		0.05
	0.24		0.13		0.05
	0.24		0.13		0.05
	0.24		0.12		0.05
	0.24		0.12		0.04
	0.24		0.12		0.04
	0.24		0.12		0.04
	0.24		0.12		0.04
	0.23		0.12		0.04
	0.23		0.12		0.04
	0.23		0.11		0.04
	0.22		0.11		0.04
	0.21		0.10		0.04
	0.21		0.10		0.04
	0.21		0.10		0.03
	0.21		0.10		0.03
	0.21		0.10		0.03
	0.20		0.10		0.03
	0.20		0.10		0.03
	0.20		0.10		0.03
	0.20		0.10		0.03
	0.19		0.10		0.03
	0.19		0.09		0.03
	0.19		0.09		0.03
	0.18		0.09		0.03
	0.18		0.09		0.03
	0.18		0.09		0.02
	0.18		0.08		0.02
	0.18		0.08		0.02
	0.18		0.08		0.02
	0.17		0.08		0.02
	0.16		0.08		0.02
	0.16		0.08		0.02
	0.16		0.07		0.02

B-35

# CONFIDENTIAL

# CONFIDENTIAL

<u>Zone</u>	<u>Weight</u>	<u>Zone</u>	<u>Weight</u>	<u>Zone</u>	<u>Weight</u>
11	0.01	12	0.14	13	2.17
	0.01		0.08		2.08
	0.01		0.07		2.05
	0.01	Total	86.95		2.04
	0.01	13	27.39		1.96
	0.01		25.12		1.87
	0.01		21.60		1.87
	0.01		18.16		1.76
	0.01		17.93		1.69
	0.01		17.28		1.66
	0.01		16.05		1.65
	0.01		13.30		1.45
	0.01		12.17		1.40
	0.01		11.68		1.36
Total	3912.61		9.83		1.35
			9.69		1.27
12	12.74		9.60		1.08
	12.30		9.59		1.04
	10.76		9.37		1.00
	10.10		9.30		0.95
	7.42		7.69		0.89
	3.85		7.12		0.80
	3.60		6.34		0.72
	2.67		6.25		0.71
	2.66		6.14		0.67
	2.60		6.07		0.50
	2.39		5.94		0.47
	2.21		5.40		0.45
	1.75		5.37		0.42
	1.40		5.09		0.38
	1.25		4.92		0.30
	1.09		4.75		0.29
	0.95		4.55		0.26
	0.94		4.32		0.26
	0.90		3.95		0.24
	0.65		3.86		0.21
	0.62		3.85		0.19
	0.60		3.75		0.08
	0.55		3.69		0.07
	0.45		3.16		0.06
	0.42		3.10		0.04
	0.38		2.76		
	0.30		2.73	Total	401.90
	0.30		2.72	14	11.75
	0.23		2.52		9.50
	0.22		2.34		6.22
	0.20		2.20		4.85
	0.16		2.20		4.33

B-36

# CONFIDENTIAL

**CONFIDENTIAL**

<u>Zone</u>	<u>Weight</u>	<u>Zone</u>	<u>Weight</u>	<u>Zone</u>	<u>Weight</u>
14	3.05	16	8.94	17	1.40
	3.00		3.12		1.35
	2.85		2.40		1.33
	2.62		1.39		1.32
	2.50		0.64		1.26
	2.26		0.42		1.25
	1.90		0.38		1.23
	1.80		0.27		1.21
	1.43		0.14		1.20
	1.26		0.07		1.18
	1.21		0.02		1.14
	1.20				1.11
	0.97	Total	17.79		1.10
	0.89				1.05
	0.85	17	24.72		1.05
	0.80		14.06		1.15
	0.79		12.78		0.92
	0.77		12.30		0.91
	0.70		7.85		0.87
	0.65		7.69		0.86
	0.61		7.56		0.80
	0.59		7.28		0.78
	0.57		7.11		0.76
	0.52		6.05		0.69
	0.45		5.57		0.66
	0.43		5.47		0.65
	0.35		5.37		0.65
	0.34		5.25		0.62
	0.27		5.14		0.61
	0.20		4.52		0.60
	0.17		4.42		0.60
	0.10		4.10		0.59
	0.04		3.75		0.56
			3.30		0.55
Total	72.79		3.20		0.53
			3.12		0.52
15	7.36		3.09		0.45
	4.17		2.70		0.42
	3.20		2.70		0.40
	2.31		2.65		0.40
	2.02		2.60		0.40
	0.90		2.51		0.39
	0.64		2.23		0.39
	0.60		2.16		0.37
	0.53		1.89		0.37
	0.37		1.73		0.35
	0.03		1.70		0.35
			1.69		0.32
Total	22.13		1.59		0.32

**CONFIDENTIAL**

<u>Zone</u>	<u>Weight</u>	<u>Zone</u>	<u>Weight</u>	<u>Code</u>	<u>Zone</u>	<u>Weight</u>	<u>Code</u>
17	0.30	18	6.40		18	1.41	
	0.30		6.28	B		1.40	
	0.25		6.26			1.39	
	0.25		6.10			1.34	
	0.25		5.59			1.27	
	0.24		5.15			1.25	
	0.23		5.14			1.25	
	0.22		5.13			1.24	
	0.21		4.75			1.20	
	0.21		4.44			1.20	
	0.20		4.27			1.20	
	0.20		4.27			1.20	
	0.20		3.95			1.19	
	0.19		3.86			1.15	
	0.18		3.25			1.15	B
	0.15		3.21			1.14	
	0.15		3.13			1.07	
	0.05		3.10			1.07	
	0.05		2.97			1.06	
	0.04		2.95			1.04	
	0.95		2.66			1.03	
	0.79		2.62			1.02	
			2.59			0.97	
<b>Total</b>	<b>233.45</b>		2.57			0.95	
			2.55			0.95	
18	49.40		2.50			0.87	
	44.00		2.45			0.86	
	38.28		2.40			0.85	
	18.55		2.40			0.85	
	17.28		2.34			0.83	
	14.88		2.32			0.80	
	14.09		2.25			0.78	
	13.25		2.25			0.75	
	12.55		2.24			0.74	
	11.38		2.12			0.70	
	10.83		2.05			0.69	
	10.75		2.05			0.62	
	10.67		1.91			0.60	
	10.24		1.82			0.60	
	9.90		1.80			0.55	
	9.60		1.78			0.55	
	9.58		1.75			0.52	
	8.97		1.71			0.50	
	8.74		1.70			0.50	
	8.72		1.69			0.46	
	8.70		1.64			0.46	
	8.50		1.60			0.41	
	7.80		1.55			0.37	
	7.04		1.47			0.35	
	6.63		1.47			0.34	
			1.45			0.34	

B-38

**CONFIDENTIAL**



# CONFIDENTIAL

<u>Zone</u>	<u>Weight</u>	<u>Code</u>	<u>Zone</u>	<u>Weight</u>	<u>Code</u>	<u>Zone</u>	<u>Weight</u>	<u>Code</u>
18	0.33		19	5.56	B	19	1.20	B
	0.33			5.45	B		1.18	
	0.32			5.25	B		1.14	B
	0.32			5.00			1.09	
	0.30			4.91	B		1.06	
	0.30			4.75			1.02	B
	0.26			4.29	B		1.00	B
	0.26			4.20	B		0.93	B
	0.25	B		4.15	B		0.88	
	0.22			3.96	B		0.87	B
	0.22			3.94	B		0.80	B
	0.21			3.82	B		0.80	B
	0.21			3.66			0.79	
	0.20			3.62			0.71	
	0.19			3.45			0.70	B
	0.19			3.30	B		0.65	B
	0.19			3.30	B		0.64	B
	0.18			3.28			0.62	B
	0.18	B		3.25	B		0.60	B
	0.17			3.16	B		0.53	B
	0.16			3.05	B		0.52	B
	0.14			2.90	B		0.48	
	0.12			2.70	B		0.47	B
	0.12			2.52	B		0.47	B
	0.12			2.46	B		0.42	B
	0.12			2.42	B		0.42	
	0.12	B		2.40	B		0.42	
	0.11			2.30	B		0.40	B
	0.10			2.28	B		0.40	B
	0.05			2.20	B		0.36	B
	0.05			2.16	B		0.36	B
				2.16	B		0.35	
Total	575.30			2.15			0.34	B
				2.13	B		0.34	B
19	306.00	B		2.12	B		0.34	B
	41.40	B		1.98	B		0.34	B
	22.35	B		1.97	B		0.32	B
	17.48	B		1.95			0.30	B
	14.72	B		1.89	B		0.30	
	12.05	B		1.86	B		0.29	B
	8.30	B		1.85	B		0.28	B
	8.14			1.78	B		0.28	B
	7.62	B		1.75	B		0.25	
	7.54	B		1.49	B		0.25	B
	7.20	B		1.40	B		0.24	B
	6.54	B		1.35	B		0.24	B
	5.86			1.34			0.24	
	5.74	B		1.29	B		0.23	B
	5.62			1.24	B		0.22	B
	5.58			1.20	B		0.21	B

# CONFIDENTIAL

<u>Zone</u>	<u>Weight</u>	<u>Code</u>	<u>Zone</u>	<u>Weight</u>	<u>Code</u>	<u>Zone</u>	<u>Weight</u>	<u>Code</u>
19	0.20	B	19B	1.29		18B	0.41	
	0.20	B		1.22			0.39	
	0.20			1.10			0.39	B
	0.18	B		1.00			0.32	
	0.17	B		0.94			0.22	
	0.17	B		0.90			0.18	
	0.15			0.90			0.18	B
	0.15	B		0.84			0.12	
	0.15	B		0.80			0.87	
	0.15	B		0.77		Total	40.10	
	0.15	B		0.60				
	0.13	B		0.50	B			
	0.13	B		0.44				
	0.13	B		0.42				
	0.13	B		0.33				
	0.12	B		0.32	B			
	0.12	B		0.30	B			
	0.12			0.26	B			
	0.10	B		0.25	B			
	0.10	B		0.23		No.	1841	
	0.09	B		0.22	B			
	0.07	B		0.20	B	Weight Grains	14,691.28	
	0.07			0.18				
	0.06	B		0.17	B			
	0.04	B		0.15	B			
	0.04	B		0.14	B	Code: F - Fuze		
	0.04			0.10		B - Brass		
	0.03	B		0.07		NR - No Recovery		
	0.03	B		0.05	B			
	0.02	B						
	0.02	B	Total	103.25				
	0.02	B						
	0.02	B	18B	5.87				
				5.09				
Total	655.52			3.83				
				3.67				
19B	18.72	B		2.70				
	9.62			2.34				
	8.75			1.99				
	8.64			1.63				
	7.78			1.39	B			
	6.57			1.38				
	5.33			1.25				
	4.82			1.04				
	3.92	B		1.00				
	3.80			0.95				
	3.12			0.80				
	2.90			0.79				
	2.79			0.74				
	1.80			0.56				

B40

# CONFIDENTIAL

# CONFIDENTIAL

## APPENDIX C

Analytical Laboratory Report 60-AL-18  
5 February 1960

Title: Results of Fragmentation Test of 115-mm Shell, HE, XM378

Project No.: TW-201/01

Prepared for: Bomb & Fragmentation Br, Inf & Acft Wpns Div

---

### (U) INTRODUCTION

A static fragmentation test was conducted to obtain the velocity, mass, and distribution of fragments for the 115-mm HE Shell, XM378, Comp B loaded. Three shells were detonated for this purpose. This report discusses the procedures and results of the test and presents the data in the form required by the EDVAC for lethality studies.

### (U) DESCRIPTION OF TEST ARENA

A square fragmentation arena was used for this test. In this arrangement, the recovery area consists of sheets of cellotex stacked to a suitable depth and placed in a rectangular pattern from 0° to 180° as measured from the nose to the base of the shell. The other side of the arena, also rectangular, was used for velocity measurement. The velocity panels consist of 4 ft by 8 ft sheets of 0.020-inch dural with photoflash bulbs mounted behind them for back-lighting, and aluminum foil to serve as a reflecting surface.

Since the shell is symmetrical about its axis, the fragmentation characteristics are assumed to be symmetric; i.e., the fragment velocity, density, and spatial distribution obtained from one region are assumed to be equivalent to those of the symmetrically located region. Because of the possibility of irregular shell break-up in the nose and base areas, recovery boxes were placed outside the velocity targets at the nose and base ends. The recovery area was divided into angular intervals or zones, numbered 1 through 19, from the nose to the base of the shell. Zones 1 and 19 covered the angular interval 0° to 5° and 175° to 180°, respectively, as measured from the axis at the nose. Zones 2 through 18 covered the angle from 5° to 175° for each interval of 10°. The extra recovery boxes were placed at the nose, to recover fragments in areas symmetric to Zones 1 and 2, and at the base to recover fragments in areas symmetric to Zones 18 and 19.

The velocity panels were painted with a rectangular grid system to aid in locating hits on the film for velocity measurements.

A sketch of the test arena is shown in Figure 1, Inclosure 1.

C-1

# CONFIDENTIAL

(U) PROCEDURE FOR COLLECTING DATA

Weight of Fragments

After each round was detonated, the fragments were recovered from the cellotex, located with regard to zone, and weighed to an accuracy of 1% or a minimum of 0.01 grains.

Velocity of Fragments

High speed cameras (approximately 10,000 frames per second) were positioned so as to view the dural targets. The flashes of the fragment impacts on the dural were then recorded on the film record along with a millisecond time base. The flashbulb backlighting provided an additional source of light and made possible the recording of impacts that were produced by fragments with velocities too low (less than approximately 1700 fps) to produce a flash. The backlighting also provided more even illumination of each perforation than that normally obtained from impact alone. The photographic velocities,  $V_p$ , were determined from the time of flight for each fragment and the known travel distance. These distances from surface of shell to the target were calculated in such a manner that the error in the travel distance was less than  $\pm 1\%$ . The velocities were then grouped into the same angular intervals as the fragment mass data.

A detailed description of the methods used in collecting and reducing fragmentation data is contained in Report No. D&PS/APG Misc/306 dated September 1959.

(U) REDUCTION OF DATA

Initial Velocity of Fragments

The initial velocities,  $V_0$ , of the fragments for each angular interval were obtained from the equation

$$V_0 = V_p \frac{e^{\frac{ar}{m^{1/3}} - 1}}{\frac{ar}{m^{1/3}}}$$

where  $a = 12 K_d \rho^{2/3}$  ;  $K = \frac{m}{\lambda^{3/2}}$

The parameters needed to evaluate  $V_0$  by this relation were obtained as follows:

$V_p$  - Photographic velocity (fps) is the median of the velocities for each zone. These velocities were determined by the relation  $r/t$  where  $r$  was the travel distance and  $t$  was the time of flight.

$K_d$  - The value of  $K_d$  (Drag Coefficient) = .64 was obtained by determining an average value for  $K_d$  over the range of fragment velocities.  $K_d$  as a function of Mach number for a particular shaped fragment was obtained from BRL Report No. M-915.

$\rho$  - For air density a standard value of .304332 grains/in.<sup>3</sup> (standard at APG) was adjusted to conditions at the time of firing by using the relative air density obtained from the Meteorological Section, Development and Proof Services.

$K$  - The fragment shape factor  $K = 593$  was calculated from a relationship between  $K$  and  $C/m$  developed by Terminal Ballistics Laboratory, BRL. In the relation  $C/m$  is the ratio of the charge to metal weight.

$m_r$  - The representative fragment weight, used in the equation was that fragment weight for which the total weight of all the smaller fragments is one-half the total weight recovered in a particular zone.

#### Number and Density of Fragments

The scaled total number of fragments for each round was calculated from the scaled fragment densities obtained from the recovery data. The total number of fragments  $N$  was calculated by the equation

$$N = 2\pi \int_0^{\pi} \sigma(\theta) \sin \theta d\theta$$

where  $\theta$  is the angle from the nose end of the shell axis and  $\sigma(\theta)$  is the scaled number of fragments per unit solid angle for each  $10^\circ$  interval. The term "scaled" refers to an adjustment of data based on the percent of recovery.

#### (U) RESULTS

The calculated results are tabulated for each round and for the three-round average in Inclosure 2. The data are arranged in the form required by the EDVAC code for the computation of lethal areas. The fragment spray density, and the median initial velocity,  $V_0$ , are given for each  $10^\circ$  interval from  $0^\circ$  to  $180^\circ$ . The mean,  $m$ , of the fragment weights, in each weight interval and the ratio,  $q$ , of the number of fragments in each weight interval to the total number of

# CONFIDENTIAL

60-AL-18

4

fragments in the angular interval are given for each weight and angular interval.

It should be pointed out that the values of velocity, density, etc tabulated for each angular interval were computed from data obtained for a given angular width. Therefore, these are considered to be average values applicable at the midpoint of each angular interval i.e., values given for  $\theta = 60^\circ$  were derived from data obtained from  $\theta = 55^\circ$  to  $\theta = 65^\circ$ .

## Graphs

Graphs of the pertinent data: distribution of fragment weight and number, density, and velocity are presented in Figures 2-7, Inclosure 1.

## (C) DISCUSSION OF RESULTS

The weights of the components of the three shells tested are given in the following table:

### Weight in Pounds

<u>Rd. No.</u>	<u>Empty Shell</u>	<u>Loaded Shell</u>	<u>Comp B</u>	<u>Fuze</u>	<u>As Fired</u>
1	22.16	32.55	10.39	1.51	34.06
2	22.04	32.45	10.41	1.51	33.96
3	21.63	32.15	10.52	1.51	33.66

Each test item was a two-piece shell of pearlitic malleable iron. The body and base sections were joined just forward of the rotating band. No weight data were available on these separate parts of the shell.

The actual and integrated recovery data are given for the three rounds in the following table:

### Actual Recovery

<u>Rd. No.</u>	<u>Total Wt. gr.</u>	<u>Total No. of frags</u>	<u>Average Frag Wt. Gr.</u>	<u>As Fired Metal Parts Wt. lb.</u>
1	14374.12	1886	7.62	23.67
2	14593.25	1833	7.96	23.55
3	14691.29	1841	7.98	23.14

C-4

# CONFIDENTIAL

**CONFIDENTIAL**

60-AL-18  
5

**Integrated Recovery**

<u>Rd. No.</u>	<u>Wt. Lb.</u>	<u>No. of Frags</u>	<u>Ave Frag Wt. Gr.</u>	<u>Percent Recovery</u>	<u>Scaled No. of Frags</u>
1	22.263	31836	4.90	94.1	33841
2	21.165	24903	5.95	89.9	27717
3	20.177	30328	4.66	87.2	34787
Ave			5.11	90.4	32115

The data above shows approximately 20% fewer fragments for Rd. No. 2 than the average of the other two rounds. A further separation was made to more clearly define the differences in the scaled number of fragments for the three rounds.

**Number and Percent of Fragments per Angular Interval**

<u>Rd. No.</u>	<u>0° - 75°</u>		<u>75°-115°</u>		<u>115°-180°</u>	
	<u>No.</u>	<u>% of Total</u>	<u>No.</u>	<u>% of Total</u>	<u>No.</u>	<u>% of Total</u>
1	1315	3.9	27691	81.8	4836	14.3
2	2008	7.2	20392	73.6	5317	19.2
3	1296	3.7	28224	81.1	5266	15.1

As shown in the above tabulation, approximately 75% of the fragments were in an angular interval extending from approximately 75°-115°.

Also, a difference of approximately 8000 fragments is shown between Rd. 2 and the average of Rds. 1 and 3 for this angular interval. Inasmuch as about 40% of the fragments were in the smallest weight interval, 0-1 grains, a tabulation of the number of fragments for the above angular intervals was made excluding the fragments in the 0-1 grain weight interval. These values are given below.

**Number of Fragments per Angular Interval  
(Excluding frags. weighing less than 1 gr)**

<u>Rd. No.</u>	<u>0°-75° No.</u>	<u>75°-115° No.</u>	<u>115°-180° No.</u>	<u>0°-180° No.</u>
1	700	14873	2631	18204
2	801	13224	2676	16701
3	564	15539	3117	19220

From these data it is apparent that while there is shown to be a difference in the number of fragments for the shell tested, most of this difference occurred in the number of fragments weighing less than one grain, indicating that Rd. 2 produced slightly heavier fragments.

C-5

**CONFIDENTIAL**

# CONFIDENTIAL

60-AL-18

6

The initial velocities of the three rounds were in good agreement and had a maximum average of value of 7300 fps at an angle of approximately  $90^\circ$ , see Figure 2, Inclosure 1. The velocities for the individual rounds actually exhibited two maximum values in this area, one occurring at  $90^\circ$  and the other at  $110^\circ$ . Furthermore the maximum fragment density occurred at an angle of approximately  $100^\circ$  for all rounds. The variation between rounds in maximum fragment density in the main spray area (Figure 3, Inclosure 1) reflects the effect of the small fragments, 0-1 grains.

The plot of  $N(m)$  vs  $m^{1/2}$  see Figure 7, Inclosure 1, shows a good fit to Mott's Law for fragments weighing less than approximately 250 grains, which would include almost all of the fragments.

SUBMITTED:

*Henry L. Barnhart*  
Henry L. Barnhart  
Mathematician

REVIEWED:

*J. E. Steedman*  
J. E. Steedman  
Chief, Ballistics Section

APPROVED:

*A. E. Karp*  
A. E. KARP  
Chief, Analytical Laboratory

Engineering Laboratories  
Supporting Services  
Development and Proof Services  
Aberdeen Proving Ground, Maryland

Inclosure 1

- Figure 1 Sketch of Fragmentation Arena
- Figure 2 Plot of Initial Velocity,  $V_0$ , vs angle  $\theta$
- Figure 3 Plot of Fragment Density,  $\rho$ , vs Angle  $\theta$
- Figure 4 Graph of percent Wt. and No. vs Wt. Interval
- Figure 5 Plot of Scaled no. of Frags vs Angle  $\theta$
- Figure 6 Plot of Accumulated No. Vs Angle  $\theta$
- Figure 7 Plot of  $N(m)$  vs  $m^{1/2}$

Inclosure 2

Tabulated Data

C-6

# CONFIDENTIAL



# CONFIDENTIAL

60-AL-18  
7

## Fragmentation Arena

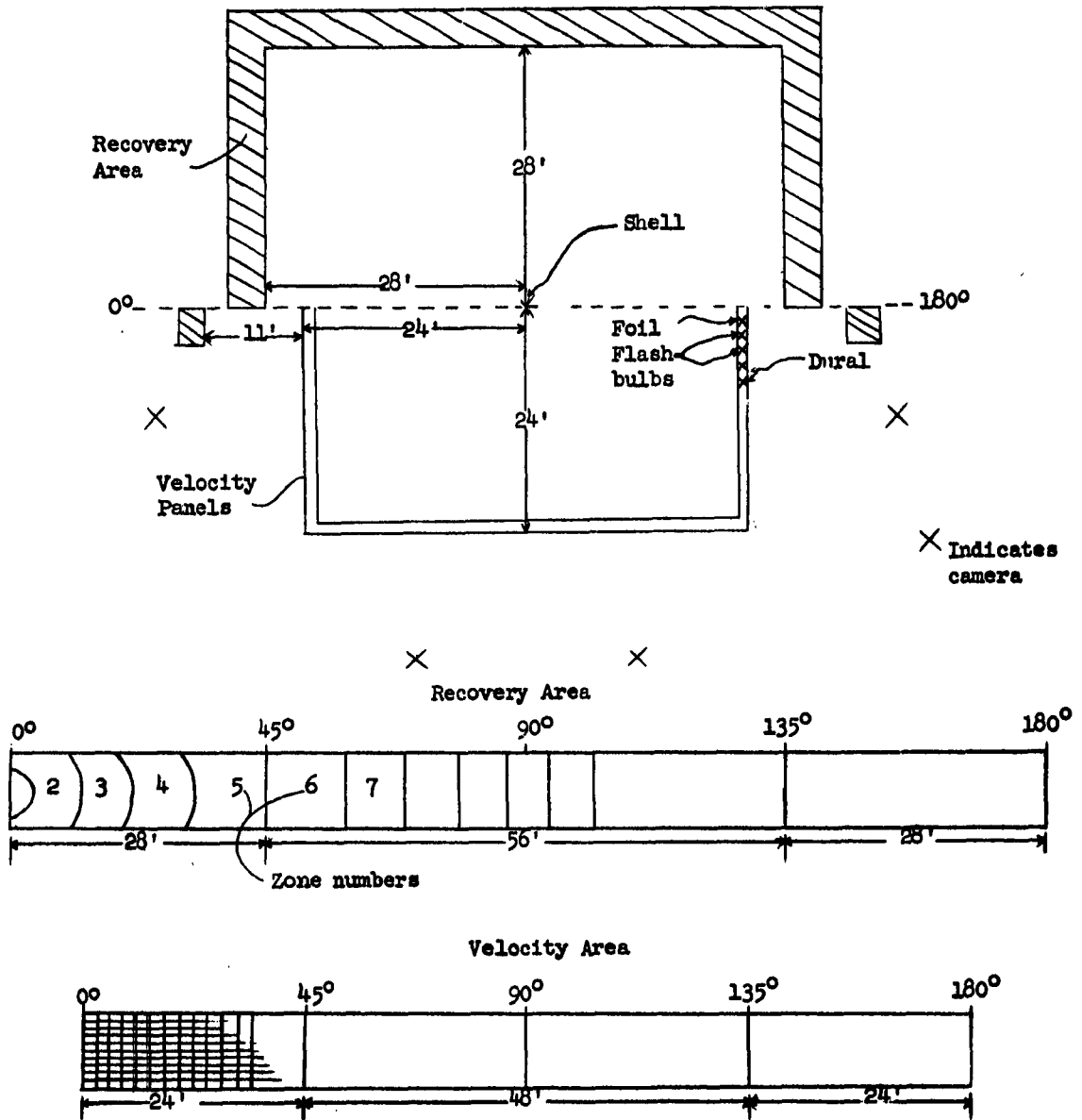

Inclosure 1, Figure 1

C-7

Anal Lab, Engr Labs, D&PS  
Feb 60 HLB

# CONFIDENTIAL

60-AL-18  
8

Initial Velocity,  $V_0$ , vs Angle  
115-mm Shell, HE, XM378

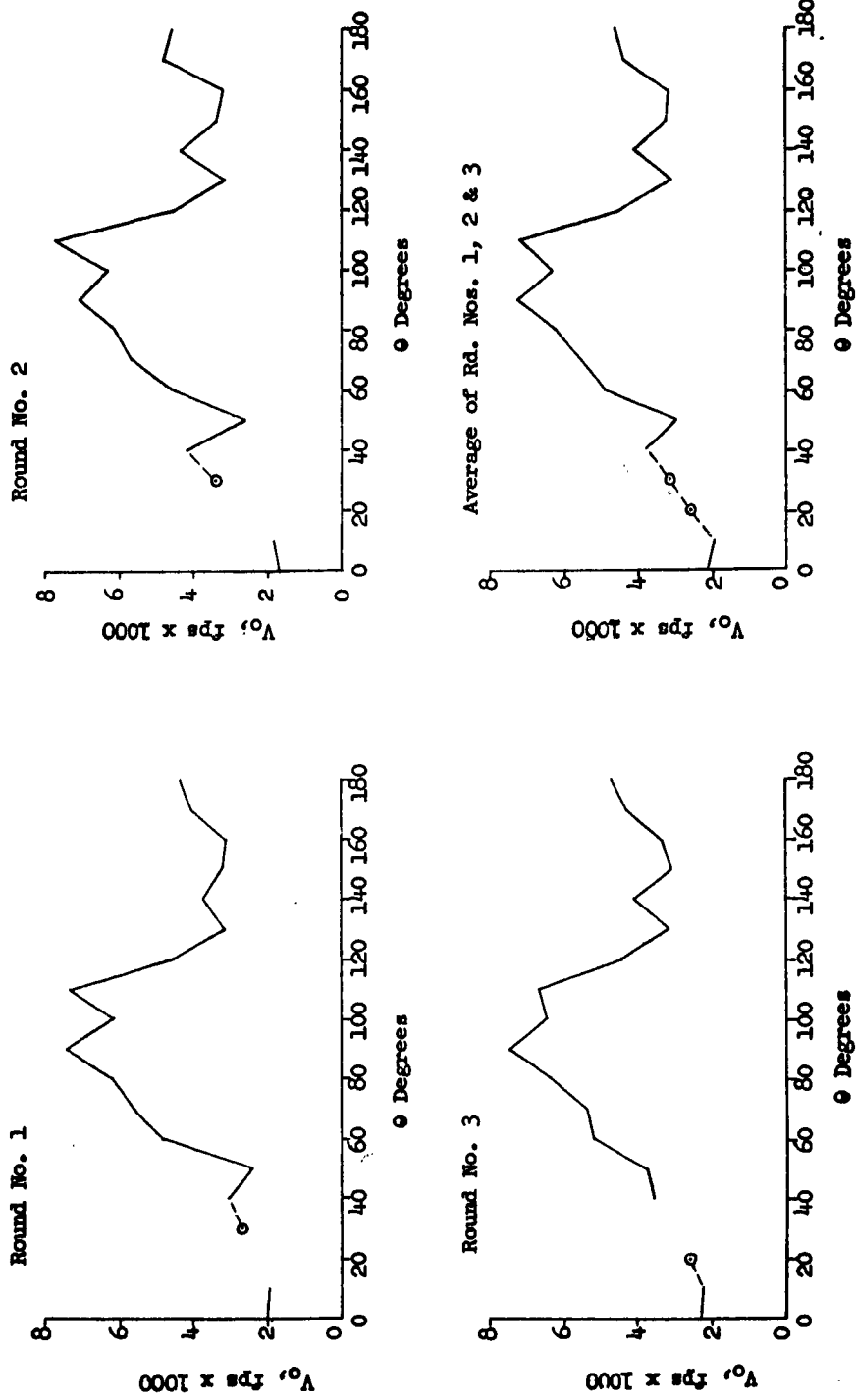

CONFIDENTIAL

CONFIDENTIAL

Inclosure 1, Figure 2

● measured from fuze end of shell

Anal Lab, Engr Labs, DAFS  
Feb 60  
HJB

CONFIDENTIAL

60-AL-18  
9

Fragment Density,  $C'$ , vs Angle  $\theta$   
115-mm Shell, HE, XM378

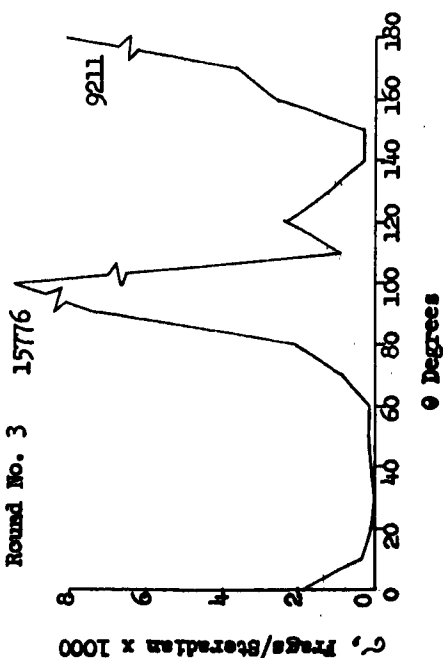
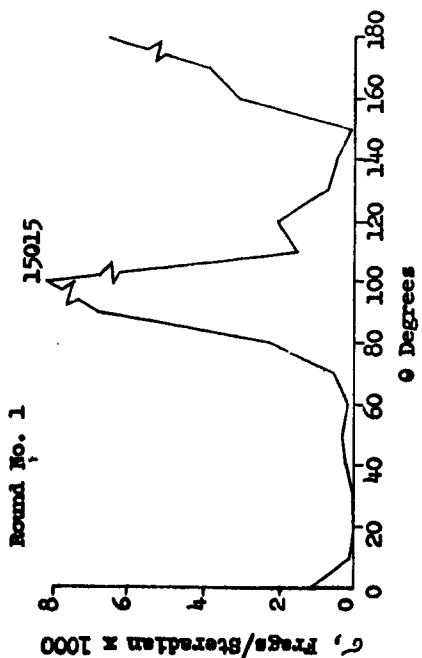
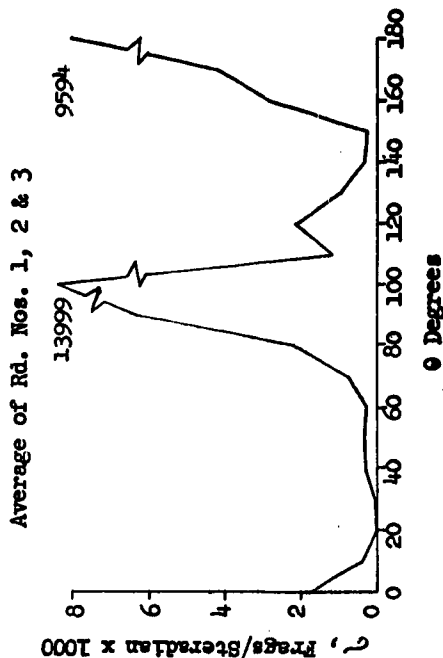
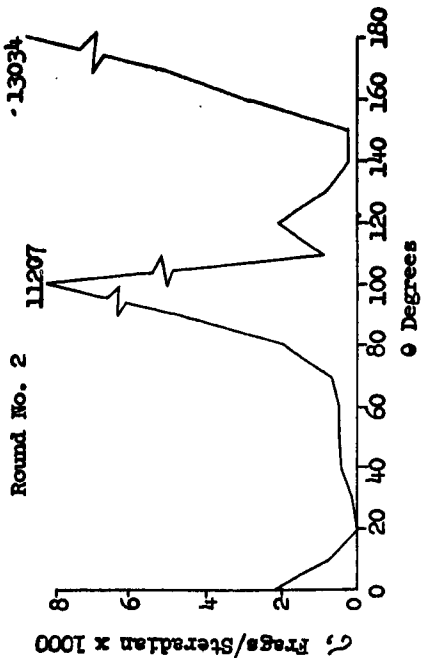

$\theta$  measured from fuze end of shell

Anal Lab, Engr Labs, D&PS  
Feb 60 HLB

Inclosure 1, Figure 3

6-3  
CONFIDENTIAL

**CONFIDENTIAL**

60-AL-18  
10

Percent Weight and Number ( $q_m$ ,  $q_n$ ) vs  
Weight Interval  
115-mm Shell, HE, XM378  
Average of Rds.: 1, 2, and 3

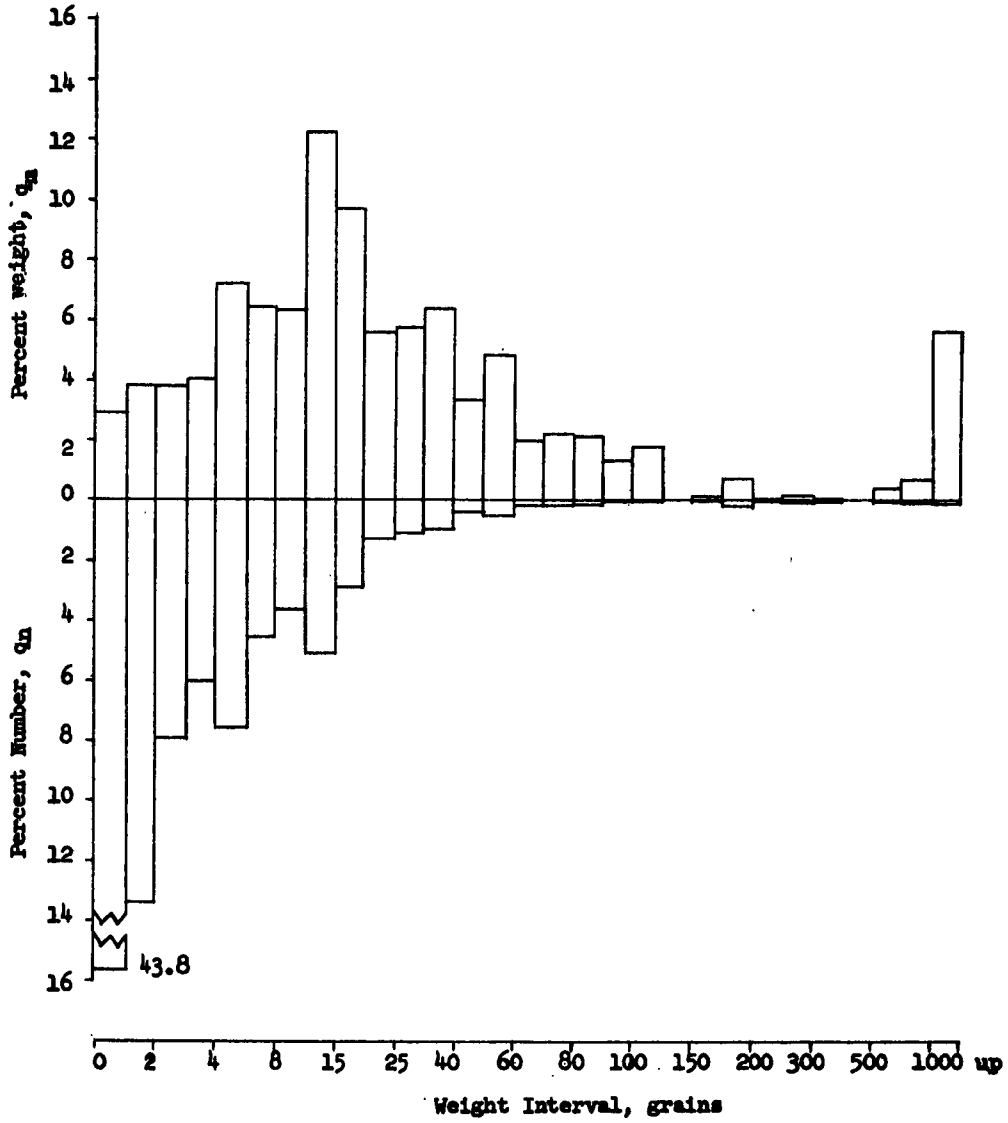

Inclosure 1, Figure 4

Anal Lab, Engr Labs, D&PS  
Feb 60 HLB

C-10

**CONFIDENTIAL**

CONFIDENTIAL

60-21-18  
11

Scaled Number of Fragments vs Angle  $\theta$   
115-mm Shell, HE, XM378  
Average of Rds. 1, 2 and 3

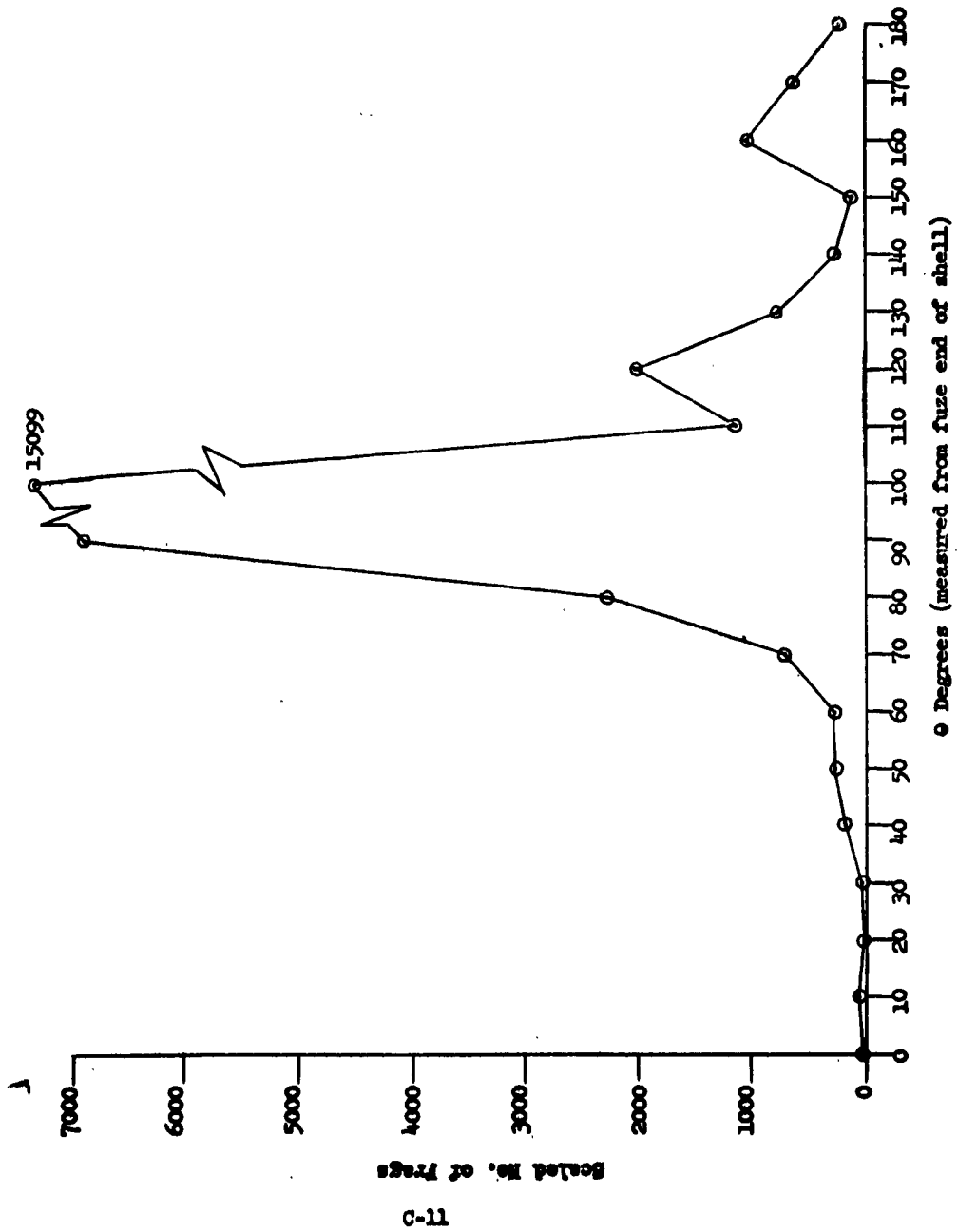

Anal Lab, Engr Labs, DAFB  
Feb 60  
MLB

Inclosure 1, Figure 5

CONFIDENTIAL

CONFIDENTIAL

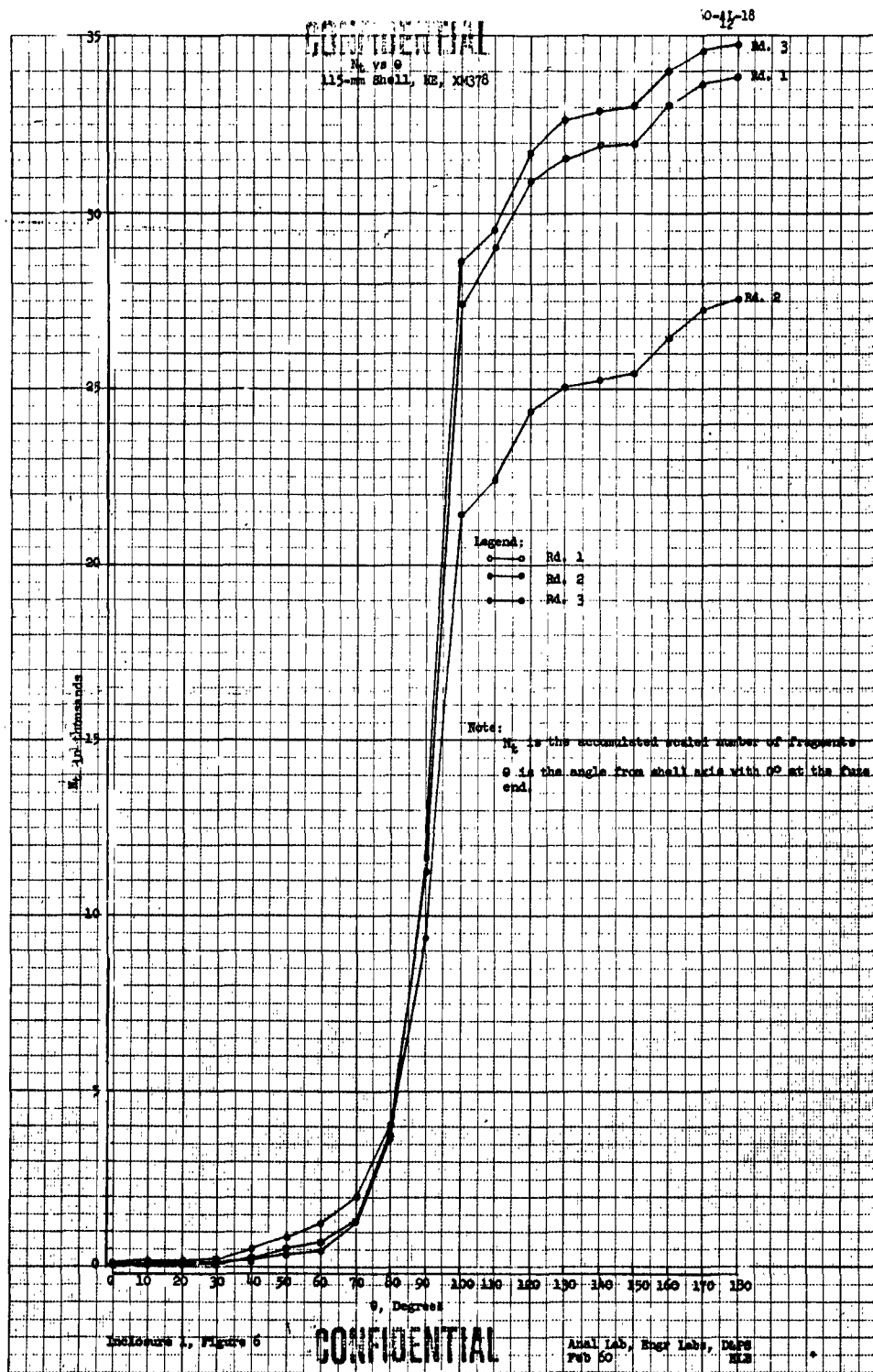

C-12

CONFIDENTIAL

**CONFIDENTIAL**

60-AL-14  
13

$N(m)$  vs  $m^{\frac{1}{2}}$   
115-mm Shell, HE, XM378  
Average of Rd. Nos.: 1, 2 & 3  
Dates of Firing: 4, 12, & 20 Nov 1959

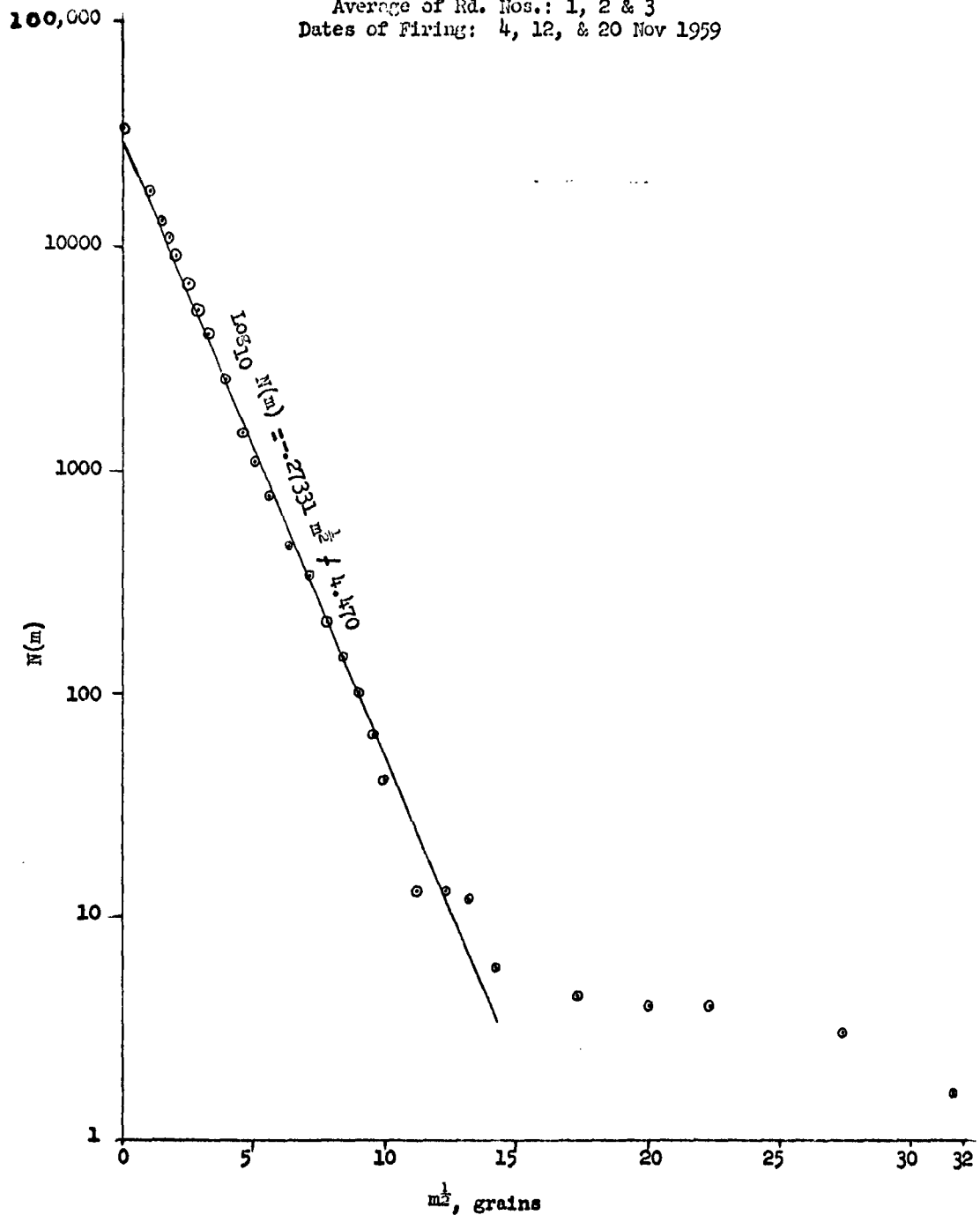

$N(m)$  = number of fragments of weight greater than  $m$

Inclosure 1, Figure 7

C-13

Anal Lab, Engr Labs, D&PS  
Feb 60  
HLB

**CONFIDENTIAL**

# CONFIDENTIAL

60-AL-18  
14

## Fragment Velocity and Density

Ave of Rds., 1, 2, & 3

Dates of Firing: 4, 12 & 20 Nov 1959

$\theta$ Degrees	$V_0$ Initial Velocity, fps	Density Frag/Steradian
0	2100	1707
10	1950	392
20	<sup>a</sup> 2550	24
30	<sup>a</sup> 3200	42
40	3800	265
50	3000	300
60	4900	267
70	5550	694
80	6200	2124
90	7300	6300
100	6300	13999
110	7200	1112
120	4500	2140
130	3150	900
140	4100	369
150	3300	239
160	3250	2780
170	4350	4513
180	4600	9594

In the equation

$$V_r = V_0 e^{-\frac{ar}{m}}$$

where  $V_r$  and  $V_0$  are velocities in feet per second,  
 $m$  is weight in grains, and  $r$  is distance in feet,

$a = .033$  for standard conditions

Percent Recovery = 90.4

<sup>a</sup>Interpolated values

Anal Lab, Engr Labs, D&PS  
Feb 60  
HLB

C-14  
**CONFIDENTIAL**



**CONFIDENTIAL**

60-AL-18

19

Fragment Velocity and Density

Round Number 1

Date of Firing: 4 Nov 1959

$\theta$ Degrees	$V_0$ Initial Velocity fps	$\sigma$ Density Frag/Steradian
0	2000	1156
10	1950	129
20		0
30	<sup>a</sup> 2700	24
40	3050	275
50	2400	308
60	4800	199
70	5550	596
80	6200	2298
90	7400	6790
100	6150	15015
110	7300	1535
120	4600	2036
130	3150	729
140	3750	522
150	3250	97
160	3150	3000
170	4050	3856
180	4350	6536

In the equation

$$V_r = V_0 e^{-\frac{ar}{m^{1/3}}}$$

where  $V_r$  and  $V_0$  are velocities in feet per second,  
 $m$  is weight in grains, and  $r$  is distance in feet,

$a = .033$  for standard conditions

Percent Recovery = 94.1

<sup>a</sup>Interpolated values

Anal Lab, Engr Labs, D&PS  
Jan 60 HLB

C-15

**CONFIDENTIAL**

# CONFIDENTIAL

60-AL-18

24

## Fragment Velocity and Density

Round Number 2

Date of Firing: 12 Nov 1959

$\theta$ Degrees	$V_0$ Initial Velocity, fps	Density Frag/Steradian
0	1700	2141
10	1850	731
20		0
30	<sup>a</sup> 3400	102
40	4150	403
50	2650	411
60	4550	468
70	5650	696
80	6100	1902
90	7050	4830
100	6300	11207
110	7700	936
120	4500	2080
130	3150	822
140	4350	259
150	3350	331
160	3200	2817
170	4800	6018
180	4550	13034

In the equation

$$V_r = V_0 e^{-\frac{ar}{m^{1/3}}}$$

where  $V_r$  and  $V_0$  are velocities in feet per second,  
 $m$  is weight in grains, and  $r$  is distance in feet,

$a = .033$  for standard conditions

Percent Recovery = 89.9

<sup>a</sup>Interpolated values

Anal Lab, Engr Labs, D&PS  
Feb 60 HLB

C-16

# CONFIDENTIAL

# CONFIDENTIAL

60-AL-18

29

## Fragment Velocity and Density

Round Number 3

Date of Firing: 20 Nov 1959

<u>θ</u> <u>Degrees</u>	<u>V<sub>o</sub></u> <u>Initial Velocity,</u> <u>fps</u>	<u>σ</u> <u>Density</u> <u>Frag/Steradian</u>
0	2250	1823
10	2000	317
20	<sup>a</sup> 2550	71
30		0
40	3600	119
50	3750	181
60	5200	134
70	5400	791
80	6350	2173
90	7500	7280
100	6500	15776
110	6700	865
120	4450	2305
130	3250	1149
140	4100	326
150	3150	289
160	3400	2523
170	4300	3666
180	4750	9211

In the equation

$$V_r = V_o e^{-\frac{ar}{m^{1/3}}}$$

where  $V_r$  and  $V_o$  are velocities in feet per second,  
 $m$  is weight in grains, and  $r$  is distance in feet,

$a = .033$  for standard conditions

Percent Recovery = 87.2

<sup>a</sup>Interpolated values

Anal Lab, Engr Labs, D&PS  
Jan 60 HLB

C-17

# CONFIDENTIAL