

UNCLASSIFIED

AD 296 262

*Reproduced
by the*

**ARMED SERVICES TECHNICAL INFORMATION AGENCY
ARLINGTON HALL STATION
ARLINGTON 12, VIRGINIA**



UNCLASSIFIED

NOTICE: When government or other drawings, specifications or other data are used for any purpose other than in connection with a definitely related government procurement operation, the U. S. Government thereby incurs no responsibility, nor any obligation whatsoever; and the fact that the Government may have formulated, furnished, or in any way supplied the said drawings, specifications, or other data is not to be regarded by implication or otherwise as in any manner licensing the holder or any other person or corporation, or conveying any rights or permission to manufacture, use or sell any patented invention that may in any way be related thereto.

CATALOGED BY ASI
AS AD NO. 296262

296 262

Heat Dissipation through Diode Lead Wires under Steady-state Conditions

Supplement 1: *Heat Dissipation by Natural or Forced Convection*

OCTOBER 1962

Prepared by W. D. BUCKMAN

Prepared for COMMANDER SPACE SYSTEMS DIVISION

UNITED STATES AIR FORCE

Inglewood, California



AEROSPAC CORPORATION
CONTRACT NO. AF 04(695)-169

ASTIA

Feb 19 1969

HEAT DISSIPATION THROUGH DIODE LEAD WIRES
UNDER STEADY-STATE CONDITIONS

Supplement 1: HEAT DISSIPATION BY NATURAL OR FORCED CONVECTION

by
W. D. Buckman

AEROSPACE CORPORATION
El Segundo, California

Contract Nos. AF 04(647)-930
AF 04(695)-169

October 1962

Prepared for
COMMANDER SPACE SYSTEMS DIVISION
UNITED STATES AIR FORCE
Inglewood, California

HEAT DISSIPATION THROUGH DIODE LEAD WIRES
UNDER STEADY-STATE CONDITIONS

Supplement 1: HEAT DISSIPATION BY NATURAL OR FORCED CONVECTION

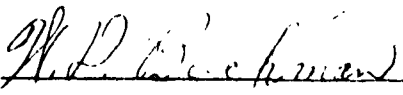
Prepared by 
W. D. Buckman

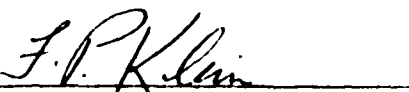
Approved by 
F. P. Klein
Head, Reliability Department

AEROSPACE CORPORATION
El Segundo, California

ABSTRACT

This report presents applicable theoretical considerations, mathematical relationships, and typical calculations for predicting steady-state heat flow from small-diameter wires, wire leads, and rods as a result of natural or forced convection occurring under given ambient conditions. The two specific cases of heat dissipation from wire leads which are considered are the heat flows resulting from the uniform heating which occurs within a given wire length due to I^2R losses and from heat entering only one end of a lead wire.

CONTENTS

1.	INTRODUCTION	1
2.	THEORETICAL DISCUSSION	2
2.1	Heat Generated Uniformly Within a Wire or Rod	2
2.1.1	Natural Convection	2
2.1.2	Forced Convection	3
2.2	Heat Entering One End of a Wire or Rod	4
2.2.1	Conduction Only	4
2.2.2	Convection and Conduction Combined	4
2.3	Sample Calculations for a Typical Lead-Wire/Terminal Configuration	5
2.3.1	Step 1: Establish Ratios of T_0/T_1 and W_1/T_1	6
2.3.2	Step 2: Establish Ratio of W_1/T_2 and T_1 and T_2	7
2.3.3	Step 3: Establish Ratio of W_t/T_2	8
2.3.4	Step 4: Establish Ratio of W_2/T_2	9
2.3.5	Step 5: Determine Values of T_2 , W_2 , and W_3	9
2.3.6	Step 6: Evaluate W_t , W_1 , T_1 and T_0	10
2.4	Effects of Modifying Test Configuration	11
2.4.1	Effect on W_3 of Moving Copper Terminal Flush with Lead-Wire End	11
2.4.2	Effect on $W_{3(a)}$ Above with Terminal Deleted	12
3.	CONCLUSIONS	13
	REFERENCES	15
	APPENDIX	A-i

FIGURES

1.	Lead-Wire Terminal Configuration	6
A-1.	Convection Factor, K for Various Lead-Wire Diameters and Temperatures	A-1
A-2.	Wind Velocities vs Forced Convection Factor, K_v , for Various Wire Diameters	A-2
A-3.	Natural and Forced Convection Factors, K and K_v , for 20-Mil Diameter Wire	A-3
A-4.	Natural and Forced Convection Factors, K and K_v , for 32-Mil Diameter Wire	A-4
A-5.	Natural and Forced Convection Factors, K and K_v , for 75-Mil Diameter Wire	A-5
A-6.	Natural and Forced Convection Factors, K and K_v , for 125-Mil Diameter Wire	A-6
A-7.	Natural and Forced Convection Factors, K and K_v , for 250-Mil Diameter Wire	A-7
A-8.	Thermal Impedance, H, of Metals at Various Temperatures	A-8
A-9.	Calculated Temperatures at Various Distances from a Heat Source Along a 0.5-In., 20-Mil Diameter Copper Lead Wire Under Natural and Forced Convection.	A-9
A-10.	Calculated Temperatures at Various Distances from a Heat Source Along a 0.5-In., 20-Mil Diameter Dumet Lead Wire Under Natural and Forced Convection.	A-10
A-11.	Calculated Temperatures at Various Distances from a Heat Source Along a 0.5-In., 20-Mil Diameter Nickel Lead Wire Under Natural and Forced Convection.	A-11
A-12.	Calculated Temperatures at Various Distances from a Heat Source Along a 0.5-In., 20-Mil Diameter Kovar Lead Wire Under Natural and Forced Convection.	A-12

TABLE

A-1.	Conversion Table for Convection Coefficients	A-13
------	--	------

STEADY-STATE HEAT DISSIPATION FROM LEAD WIRES AND ROD MATERIALS BY NATURAL OR FORCED CONVECTION

1. INTRODUCTION

The lead wires of electronic components may act as very effective heat dissipators under either natural or forced convection conditions if the temperature of one end of a lead wire exceeds approximately 150 degrees Centigrade in an ambient environment of 25 degrees Centigrade and sea-level pressure. The rate of heat flow resulting from convection at wind velocities even as low as one mile per hour at sea-level pressure is much greater than has generally been recognized. Also, the rate of heat dissipation by convection greatly exceeds that resulting from radiation only.

Many component operating-life tests are conducted today in chambers with unknown wind velocities and with large heat sink terminals of unknown thermal characteristics and capacities connected near the body of the unit under test. Data resulting from such tests are misleading in two areas for components with power ratings of one watt or less, in that both the advertised ratings as well as the qualification test results for each production lot of this class of units may have very little true significance.

This report presents theory and methods which permit the rate of heat dissipation from wire leads by convection under a given set of conditions to be predicted and supplements a previous analysis (Ref. 1) wherein forced convection conditions were only briefly considered. The information summarized by the curves and tabulated data in Appendix A is valid not only for the noted materials and wire and rod diameters, but also particularly for small electronic parts with wire leads whose power dissipation rating is based upon standard conditions.

Symbols applicable to this discussion are defined as follows:

W	Heat flow in milliwatts
W_0	Heat flow at point x_0 along lead wire
T_a	Ambient temperature in degrees Centigrade
T_2, T_1	Temperatures at lead wire junctions in degrees Centigrade
T, T_0	Lead wire temperature at points along the lead wire, or at point x_0 , respectively, in degrees Centigrade
K, K_v	Convection factors, average rate of heat flow in milliwatts per inch of length per mil diameter per degree Centigrade above T_a
D	Lead-wire diameter in mils
x	Distance measured along lead wire in inches
x_0	Point on lead wire exhibiting selected initial conditions W_0 and T_0
k	Average thermal conductivity
H	Thermal impedance factor = $119.9/k$

2. THEORETICAL DISCUSSION

2.1 Heat Generated Uniformly Within a Wire or Rod

This section considers heat generated at a uniform rate, or I^2R losses, at sea-level pressure within a wire or rod whose thickness is small compared to length.

2.1.1 Natural Convection

In order to predict the rate at which heat is removed from a wire or rod of given length by natural convection, the natural convection factor \underline{K} must be known. Values of \underline{K} may be obtained from Figure A-1 for several wire or rod diameters of any material at various differential temperatures between conductor surface temperature and ambient near 20 deg C. Additional data for wire and rod diameters between 0.01 and 1.0 in. are available (Ref. 2).

The heat dissipated under natural convection conditions from a wire or rod will be (Ref. 1)

$$W = KD(T - T_a)x \quad (1a)$$

For a 32-mil dia 1.5-in. long wire having a surface temperature of 120 deg C, where ambient temperature is 20 deg C, $K = 0.089$ (from Figure A-1), and end effects are assumed zero, then,

$$\begin{aligned} W &= (0.089)(32)(120 - 20)(1.5) \\ &= 427 \text{ mw} \end{aligned}$$

2.1.2 Forced Convection

To determine the amount of heat dissipated from a wire or rod under forced convection conditions the forced convection factor K_v may be evaluated from Figures A-2 through A-7, where each graph provides values of K_v for a specific diameter of any material over a range of air velocities (Ref. 3).

The heat dissipated from a wire or rod under forced convection conditions will be (Ref. 1)

$$W = K_v D(T - T_a)x \quad (1b)$$

or, for the example given in Paragraph 2.1.1 in conjunction with a 4-mph wind velocity normal to the wire and $K_v = 0.35$ (from Figure A-4),

$$\begin{aligned} W &= (0.35)(32)(120 - 20)(1.5) \\ &= 1680 \text{ mw} \end{aligned}$$

2.2 Heat Entering One End of a Wire or Rod

This section considers the effects of heat entering only one end of a wire or rod at sea-level pressure by presenting a detailed example of computations for a typical lead-wire configuration in accordance with methods and formulas previously outlined (Ref. 1). For convenience applicable formulas are restated:

2.2.1 Conduction Only

$$\frac{\Delta T}{\Delta x} = \left(\frac{W}{D^2} \right) H$$

or

$$T_2 - T_1 = \frac{W}{D^2} (x_2 - x_1) H \quad (2)$$

2.2.2 Convection and Conduction Combined

$$\left(W^2 - W_0^2 \right) = \left(\frac{KD^3}{H} \right) \left[(T - T_a)^2 - (T_0 - T_a)^2 \right] \quad (3a)$$

$$x \sqrt{\frac{KH}{D}} = \log_e \left[\frac{W + \sqrt{W^2 + \frac{KD^3}{H} (T_0 - T_a)^2 - W_0^2}}{W_0 + (T_0 - T_a) \sqrt{\frac{KD^3}{H}}} \right] \quad (3b)$$

$$x \sqrt{\frac{KH}{D}} = \log_e \left[\frac{(T - T_a) + \sqrt{(T - T_a)^2 - (T_0 - T_a)^2 + \frac{H}{KD^3} W_0^2}}{(T_0 - T_a) + W_0 \sqrt{\frac{H}{KD^3}}} \right] \quad (3c)$$

The thermal impedance factor \underline{H} in the foregoing expressions is given in Figure A-8 for a few metals over a range of temperatures. Limitations affecting Equations 3a, 3b, and 3c are that initial values of \underline{x} or x_0 must always be zero for the initial conditions T_0 and W_0 , either \underline{T} or \underline{W} must increase as \underline{x} increases and \underline{H} and \underline{K} may be considered constant for variations in $T/T_0 < 2$, depending upon the degree of accuracy desired.

Curves and tabulated data showing the effects of natural and forced convection on heat flow and wire-surface temperature, for lead wires 20 mils in diameter and 0.5 in. long with no terminal attached, are presented in Figures A-9, A-10, A-11, and A-12. These data were calculated in accordance with Equations 3b and 3c, and respectively are applicable to copper, dumet, nickel, and kovar lead-wire materials. The tabulations further indicate that the value of \underline{W} more than doubles when conditions change from natural convection to forced convection with a 4-mph air velocity. The ratios obtained for \underline{W} in this case are 3.24 for copper, 2.55 for dumet, 2.34 for nickel, and 2.01 for kovar respectively.

Also, a large heat sink attached to the end of a lead wire may increase \underline{W} by a very small percentage. For example, considering case (C) of Figure A-11 for $T_0 = 61$ deg C, $T_a = 25$ deg C, and assumption that $W_0 = 100 (T_0 - T_a)$ because of the heat sink, solution of Equation (3c) for a new T_0 yields $T_0 = 25.69$ deg C and, consequently, $W_0 = 69$ mw. Solving Equation (3a) for \underline{W} then results in $W = 229$ mw, or an 8.5 percent increase over the initial 211-mw value. It should be noted that T_0 now is practically at T_a . Also, if lead lengths of one inch were initially considered, the percentage increase in \underline{W} would be considerably less (Ref. 1, Fig. 7, Curves C1 and C2).

2.3 Sample Calculations for a Typical Lead-Wire/Terminal Configuration

The following sample calculations are for the copper wires attached to a copper rod acting as a terminal as shown in Figure 1, and illustrate procedures for evaluating the various indicated \underline{W} and \underline{T} . Terminals and lead wires are mounted horizontally in ambient conditions of 25 deg C and sea-level pressure, with a 4-mph wind velocity directed upward. It is further assumed that $T_0 = T_0' = 25$, $T_1 = T_1' = 25$, and $T_2 = T_2' = 25$, and that end effects of the lead wire and terminal are zero.

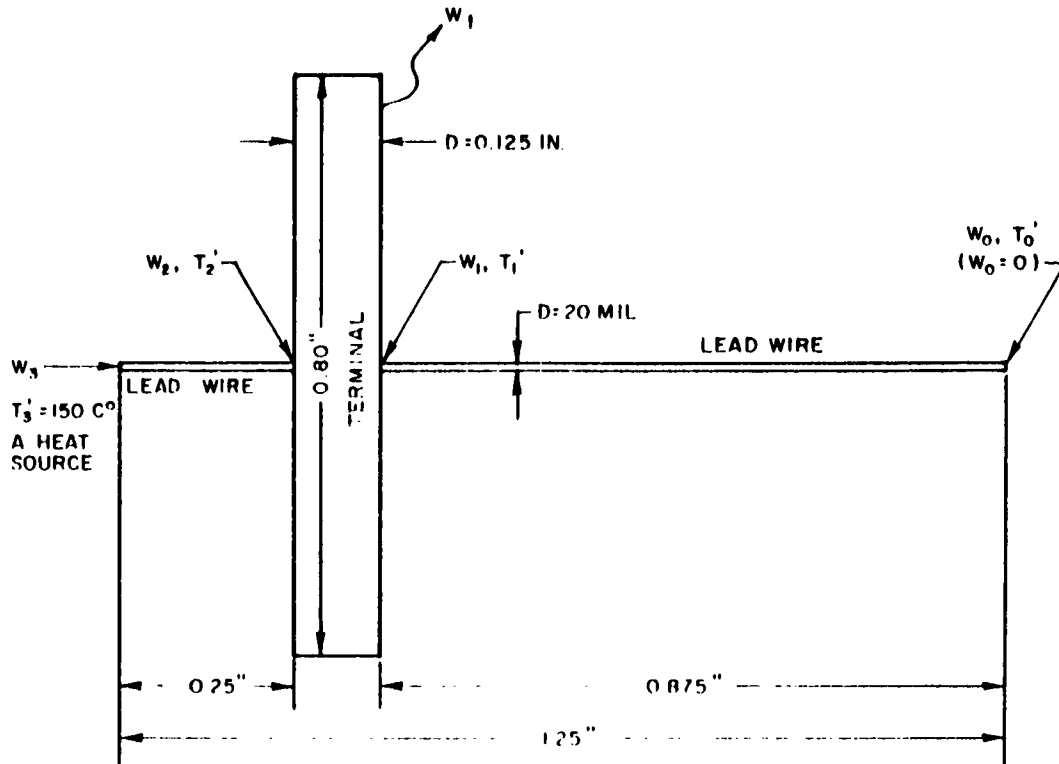

Figure 1. Lead-Wire Terminal Configuration

2.3.1 Step 1: Establish Ratios of T_0/T_1 and W_1/T_1

Taking $x_0 = 0$ and $W_0 = 0$ at T_0 , $H = 133$ for copper from Figure A-8, $K_v = 0.44$ from Figure A-3 if $(T_1 + T_0)/2 = 30$ or rechecking K_v when T_1 and T_0 are known, and substituting into Equation (3c),

$$0.875 \sqrt{\frac{(0.44)(133)}{20}} = \log_e \frac{T_1 + \sqrt{T_1^2 - T_0^2}}{T_0}$$

or

$$e^{1.495} = \frac{T_1 + \sqrt{T_1^2 - T_0^2}}{T_0} = 4.46$$

Therefore,

$$T_0 = 8.92/20.9 T_1$$

or

$$T_0 = 0.426 T_1 \quad (2.2.1-1)$$

Also, substituting into Equation (3a),

$$\left[W_1^2 = \frac{(0.44)(20)^3}{133} (T_1^2 - T_0^2) \right]$$

Then, since from (2.2.1-1) $T_0 = 0.426 T_1$,

$$W_1 = 4.66 T_1 \quad (2.2.1-2)$$

2.3.2 Step 2: Establish Ratio of W_1/T_2 and T_1/T_2

Assuming W_1 is conducted in the lead wire between T_1 and T_2 , and substituting into Equation (2),

$$T_2 - T_1 = \frac{(W_1)(133)}{20^2} \quad (0.125)$$

Since, from (2.2.1-2), $T_1 = W_1/4.66$,

$$W_1 = 3.89 T_2 \quad (2.2.1-3)$$

and

$$T_1 = 3.89/4.66 T_2$$

or

$$T_1 = 0.835 T_2 \quad (2.2.1-4)$$

It should be recognized that some error will be introduced due to the above assumption, especially if the difference between T_1 and T_2 is large.

2.3.3 Step 3: Establish Ratio of W_t/T_2

Taking $K_v = 0.165$ from Figure A-6 if $(T_2 + T_1)/2 = 40$ or rechecking K_v when T_2 and T_1 are known, and substituting into Equation (1),

$$W = (K_v) (D) (x) (T - T_a)$$

and

$$W_t = (0.165) (125) (0.80) \frac{(T_2 + T_1)}{2}$$

approximately. Also, for a rechecked temperature drop to the end of terminal when $W_t/2$ is known,

$$W_t = 8.25 (T_2 + T_1)$$

Since from (2.2.1-4) $T_1 = 0.835 T_2$,

$$W_t = 15.14 T_2 \quad (2.2.1-5)$$

2.3.4 Step 4: Establish Ratio of W_2/T_2

Assuming $W_2 = W_1 + W_t$, since $W_1 = 3.89 T_2$ from (2.2.1-3) and $W_t = 15.14 T_2$ from (2.2.1-5),

$$W_2 = 19.03 T_2 \quad (2.2.1-6)$$

2.3.5 Step 5: Determine Values of T_2 , W_2 , and W_3

Noting that $x = 0.25$ in., $x_0 = 0$ at T_2 , and initial $W = W_2$, and taking $K_v = 0.45$ from Figure A-3, if $(125 + T_2)/2 = 80$ or rechecking K_v when T_2 is known, substitution into Equation (3c) results in

$$0.25 \sqrt{\frac{0.45(133)}{20}} = \text{Log}_e \frac{125 + \sqrt{125^2 - T_2^2 + \frac{133 W_2^2}{0.45 (20)^3}}}{T_2 + W_2 \sqrt{\frac{133}{0.45 (20)^3}}}$$

Since from (2.2.1-6) $W_2 = 19.03 T_2$,

$$1.54 = \frac{125 + \sqrt{(125)^2 + 12.4 T_2^2}}{4.66 T_2}$$

and

$$T_2 = 1794/39.1$$

or

$$T_2 = 45.8^\circ\text{C}; \quad T_2' = 70.8^\circ\text{C} \quad (2.2.1-7)$$

Also, since from (2.2.1-6) $W_2 = 19.03 T_2$,

$$W_2 = (19.03)(45.8) = 873 \text{ mw} \quad (2.2.1-8)$$

Substituting (2.2.1-6) and (2.2.1-7) into Equation (3a), then,

$$(W_3)^2 - (873)^2 = \frac{(0.45)(20^3)}{133} \left[(125)^2 - (45.8)^2 \right]$$

or

$$W_3 = 1060 \text{ mw} \quad (2.2.1-9)$$

2.3.6 Step 6: Evaluate W_t , W_1 , T_1 and T_0

Since from (2.2.1-5), (2.2.1-3), (2.2.1-4), and (2.2.1-1), respectively,

$W_t = 15.14 T_2$, $W_1 = 3.89 T_2$, $T_1 = 0.835 T_2$, and $T_0 = 0.426 T_1$,

$$W_t = 694 \text{ mw} \quad (2.2.1-10)$$

$$W_1 = 178 \text{ mw} \quad (2.2.1-11)$$

$$T_1 = 38.3^\circ\text{C}; \quad T_1' = 63.3^\circ\text{C} \quad (2.2.1-12)$$

and

$$T_0 = 16.3^{\circ}\text{C}; \quad T'_0 = 41.3^{\circ}\text{C} \quad (2.2.1-13)$$

A recheck of assumed values of K_v indicates existence of only very small error. The largest error occurs in the calculation relating to the terminal diameter along the lead wire. The method of attaching the terminal to the lead wire was not stated inasmuch as each method of attachment will require a different approach depending upon the accuracy desired.

The input heat, W_3 , was calculated to be entering the lead wire at a rate of 1060 mw under the conditions given. Although many components rated at from 300 to 500 mw currently incorporate 20- and 32-mil diameter lead wires, as assumed above, both of the lead wires on a component may not be equally effective as heat dissipators. For example, practically all heat enters only one lead wire inside a diode having a whisker contact inside the glass envelope.

2.4 Effects of Modifying Test Configuration

The following results should be considered in test rack design in order to minimize the effects of terminals on power ratings.

2.4.1 Effect on W_3 of Moving Copper Terminal Flush with Lead-Wire End

Denoting quantities applicable to this test modification by (a) , and taking $x = 1.125$ in. and $K_v = 0.44$,

$$W_{2(a)} = W_0 - (0.165)(125)(0.80)(T_{2(a)})$$

or

$$W_2 = 16.5 T_{2(a)}$$

approximately. Substituting into Equation (3c) and solving for $T_{2(a)}$, then

$$T_{2(a)} = 8.93^{\circ}\text{C}; T'_{2(a)} = 33.93^{\circ}\text{C}$$

and $W_{2(a)} = 147 \text{ mw}$

Substituting into Equation (3a) and solving for $W_{3(a)}$, then

$$W_{3(a)} = 658 \text{ mw}$$

This value is in a ratio of 0.62 with the previously obtained value of $W_3 = 1060 \text{ mw}$.

2.4.2 Effect on $W_{3(a)}$ Above with Terminal Deleted

Denoting quantities applicable to this test configuration by $_{(b)}$, taking $x = 1.25 \text{ in.}$, $K_v = 0.44$, and $W_0 = 0$, and substituting into Equation (3c),

$$T_{0(b)} = 29.1^{\circ}\text{C}; T'_{0(b)} = 54.1^{\circ}\text{C}$$

Substituting into Equation (3a),

$$W_{3(b)} = 625 \text{ mw}$$

This value is in a ratio of 0.95 with the previously obtained value of $W_{3(a)} = 658 \text{ mw}$.

3. CONCLUSIONS

Lead wires may be very effective heat dissipators under standard conditions for small electronic components having internal temperatures of approximately 150 deg C or more. Inasmuch as a four-mile per hour wind velocity may increase the rate of heat removal over that provided by natural convection by as much as a factor of 4, some wattage ratings and operating life tests for production-lot qualification are of very little significance because of the unknown high wind velocities which may be present in test chambers and because large terminals with unknown heat sink capabilities often are in contact with lead wires at points near the body of the unit under test.

It has been shown that the heat flow entering one 1.25-in. long 0.020-in. dia component lead wire may approach 1000 mw or more, despite the fact that many components have wattage ratings of 250 and 500 milliwatts. This is indicative that production-lot qualification test results may be misleading unless hot spot temperatures within components approach rated values.

Because little change may be expected in test conditions due to the cost of floor space, the cost of existing test chambers at around \$50,000 each, and the impracticalities of controlling air temperature precisely without forced-air circulation, the following recommendations are presented:

- a. Wind velocities existing during tests should be measured and reported. Commercial velometers of the prod type are available that are capable of measuring air velocities of from 1 to 30 miles per hour in a very small region.
- b. The physical sizes of terminals and the positions of the terminals on the lead wires should be known and reported.
- c. Terminal materials and related heat sink capabilities in mw/deg C should be known and reported. Terminal temperature measurement should be accomplished at points where lead wires enter the terminal.

- d. A new test rack design should provide adequate terminal spacing to permit terminals to be clipped on at the ends of lead wires. This is desirable because terminals in many cases will be near room temperature so that their size will exercise very little effect on the rate at which heat enters the lead wire, and also because a considerable error may be introduced in calculation of the rate at which heat enters the wire if terminals are placed near the heat source.

REFERENCES

1. Buckman, W. D. "Heat Dissipation Through Diode Lead Wires Under Steady State Conditions," Aerospace Corporation Report TDR-930(2121)TN-1, October 1961.
2. "Method for Calculation of Current Ratings on Hookup Wire." EIA Standard RS-214. New York: Electronic Industries Association.
3. McAdams, William H. Heat Transmission. New York: McGraw-Hill Book Company, Inc., 3rd ed.

APPENDIX

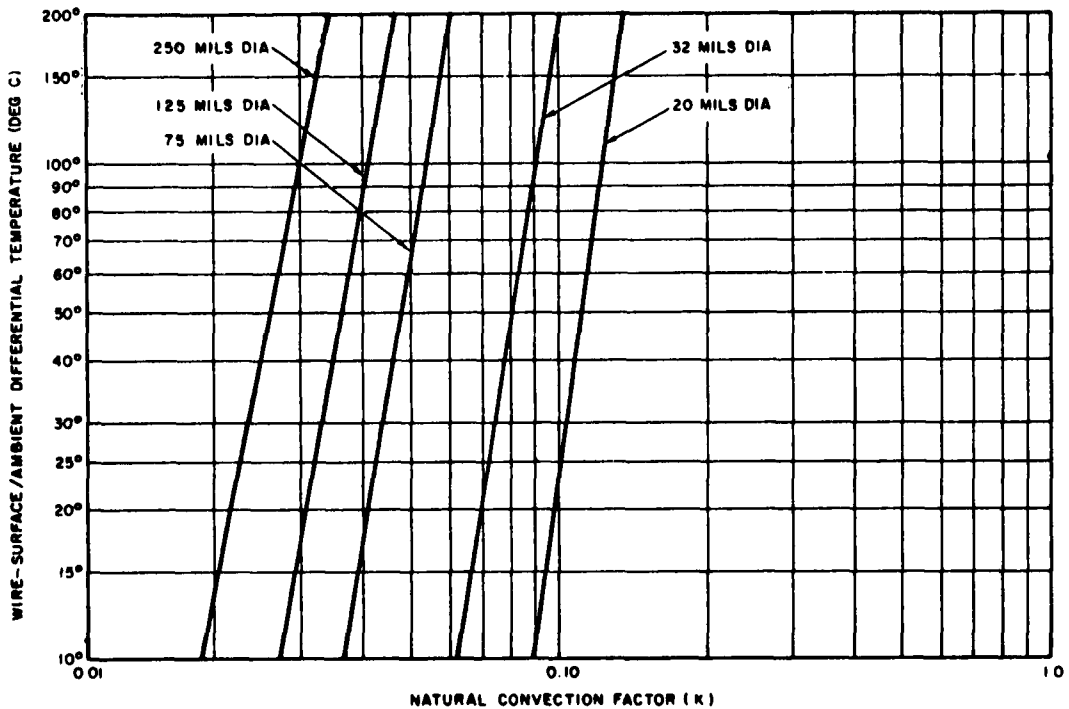

Figure A-1. Convection Factor, K for Various Lead-Wire Diameters and Temperatures. (Average milliwatts of heat flow dissipated from lead wires by convection per Centigrade degree per inch of length per mil diameter).

Curves in Figure A-1 plotted for the following test conditions:

- (a) Natural convection at ambient conditions of 20 deg C and sea-level pressure. Values of K for altitudes of 35,000 and 100,000 ft may be obtained by multiplying plotted values of K by 0.48 and 0.11 respectively.
- (b) Lead-wire surfaces with smooth clean finish.
- (c) Heat must be generated at a uniform rate within the entire conductor length.

The accuracy of the data as plotted has been verified by several spot checks under the above conditions.

Source of data plotted in Figure A-1: Ref. 2.

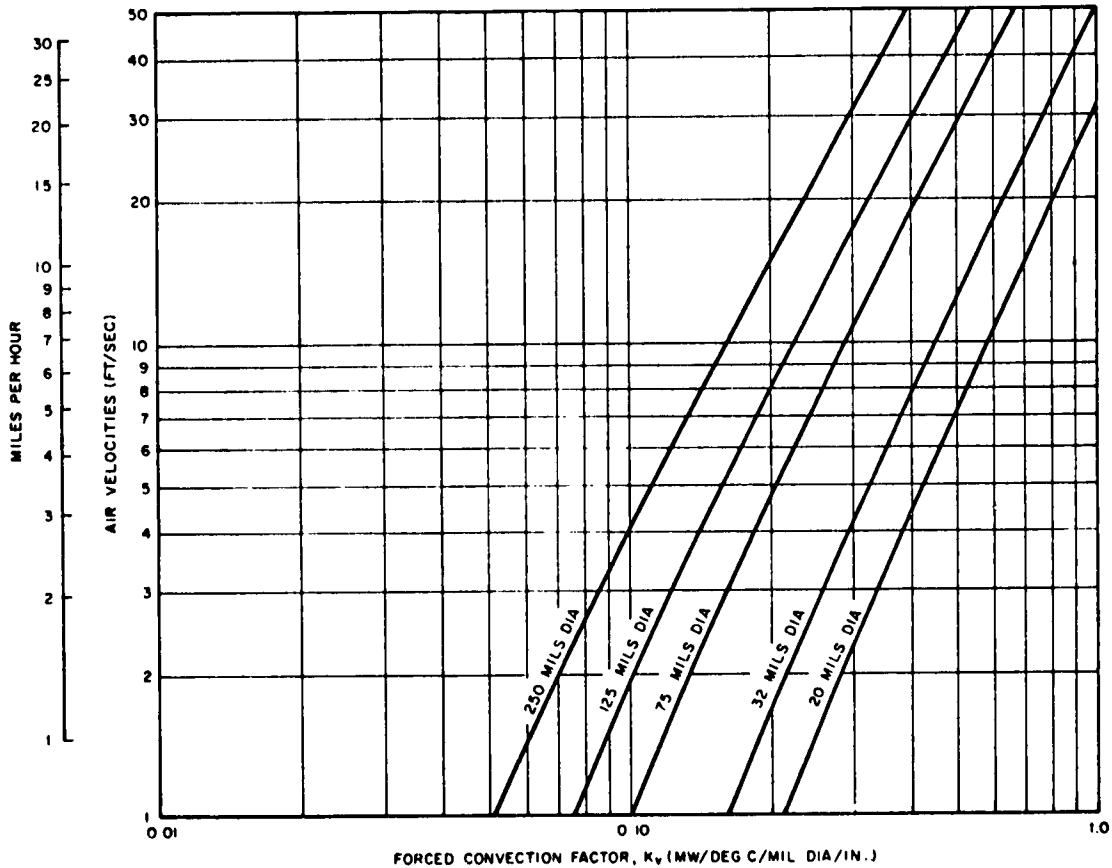

Figure A-2. Wind Velocities vs Forced Convection Factor, K_v , for Various Wire Diameters.

Curves in Figure A-2 plotted for the following test conditions:

- Smooth metal wires mounted horizontally at ambient conditions of 25 deg C and sea-level pressure.
- Wires heated internally to 125 deg C due to I^2R losses.
- Given air velocities for air moving upward past the heated wires.

Source of data plotted in Figure A-2: Computations based on formulas and curve given in Ref. 3, p 259.

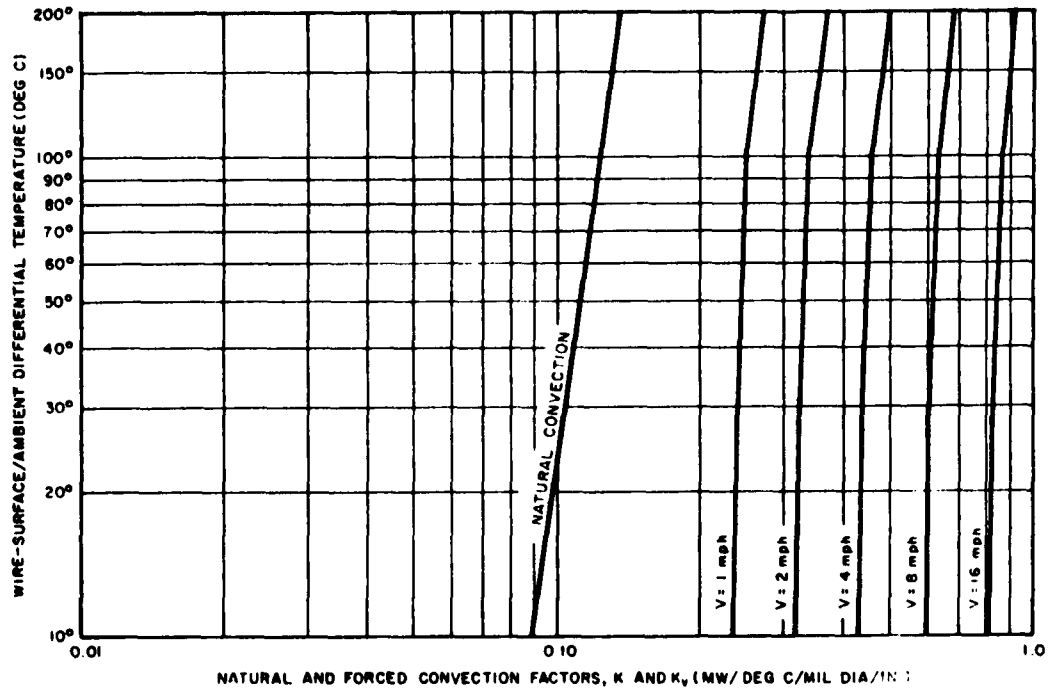

Figure A-3. Natural and Forced Convection Factors, K and K_v , for 20-Mil Diameter Wire

Curves in Figure A-3 plotted for the following test conditions:

- (a) Smooth metal wires mounted horizontally at ambient conditions of 25 deg C and sea-level pressure.
- (b) Wires heated internally due to I^2R losses.
- (c) Given air velocities for air moving upward past the heated wires.

Source of data plotted in Figure A-3: Computations based on formulas and curve given in Ref. 3, p 259.

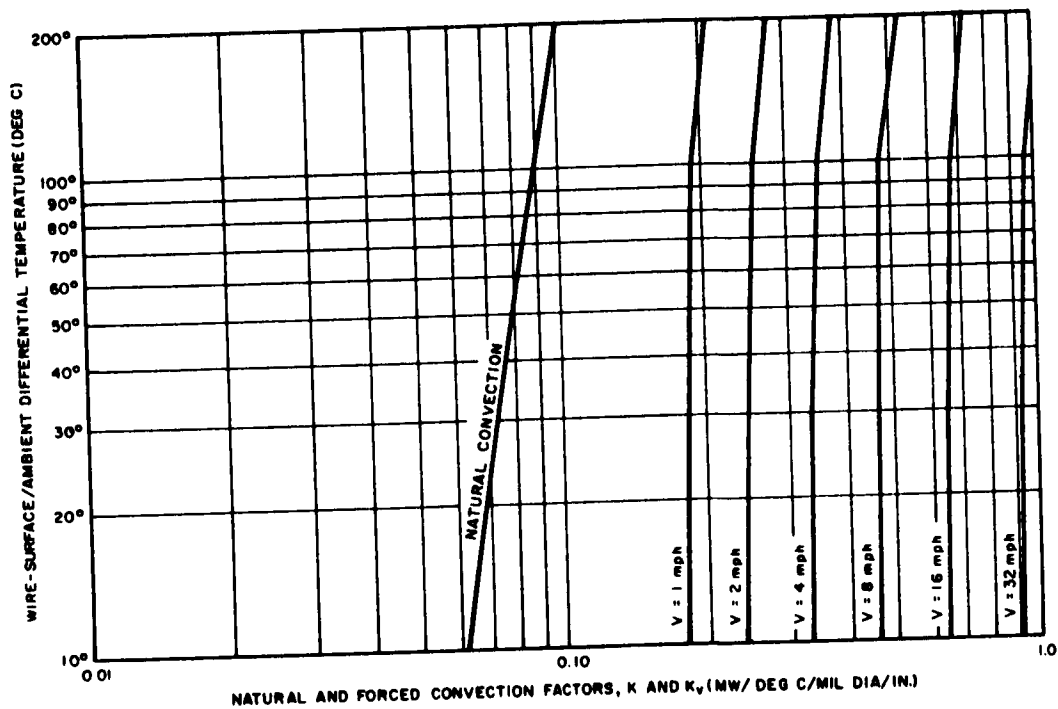

Figure A-4. Natural and Forced Convection Factors, K and K_v , for 32-Mil Diameter Wire

Curves in Figure A-4 plotted for the following test conditions:

- (a) Smooth metal wires mounted horizontally at ambient conditions of 25 deg C and sea-level pressure.
- (b) Wires heated internally due to I^2R losses.
- (c) Given air velocities for air moving upward past the heated wires.

Source of data plotted in Figure A-4: Computations based on formulas and curve given in Ref. 3, p 259.

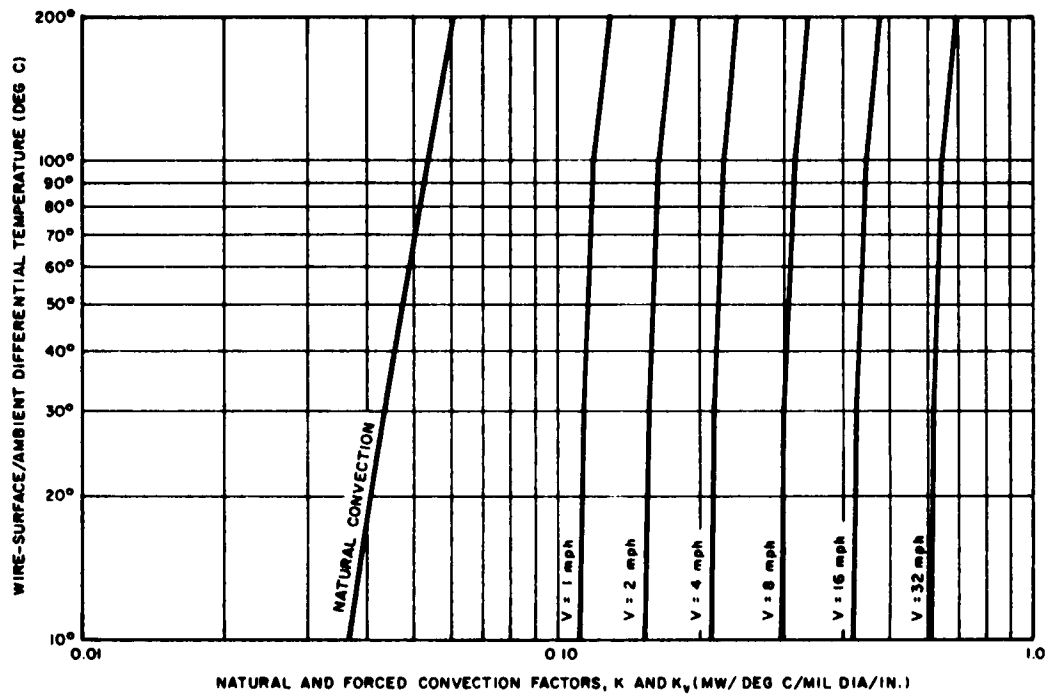

Figure A-5. Natural and Forced Convection Factors, K and K_v , for 75-Mil Diameter Wire

Curves in Figure A-5 plotted for the following test conditions:

- (a) Smooth metal wires mounted horizontally at ambient conditions of 25 deg C and sea-level pressure.
- (b) Wires heated internally due to I^2R losses.
- (c) Given air velocities for air moving upward past the heated wires.

Source of data plotted in Figure A-5: Computations based on formulas and curve given in Ref. 3, p 259.

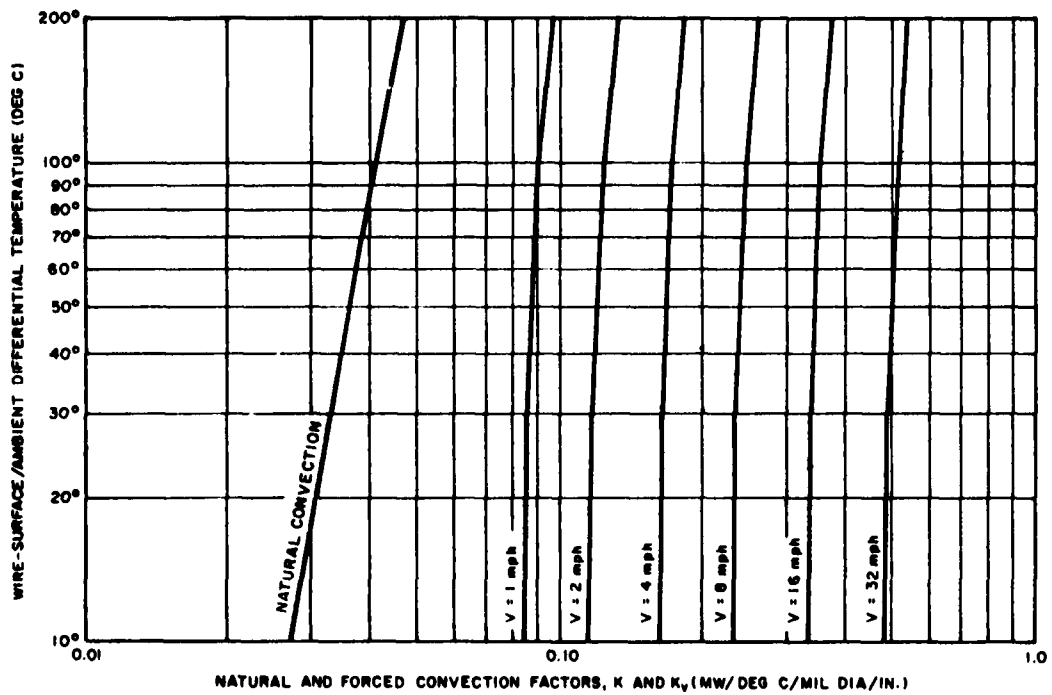

Figure A-6. Natural and Forced Convection Factors, K and K_v , for 125-Mil Diameter Wire

Curves in Figure A-6 plotted for the following test conditions:

- (a) Smooth metal wires mounted horizontally at ambient conditions of 25 deg C and sea-level pressure.
- (b) Wires heated internally due to I^2R losses.
- (c) Given air velocities for air moving upward past the heated wires.

Source of data plotted in Figure A-6: Computations based on formulas and curve given in Ref. 3, p 259.

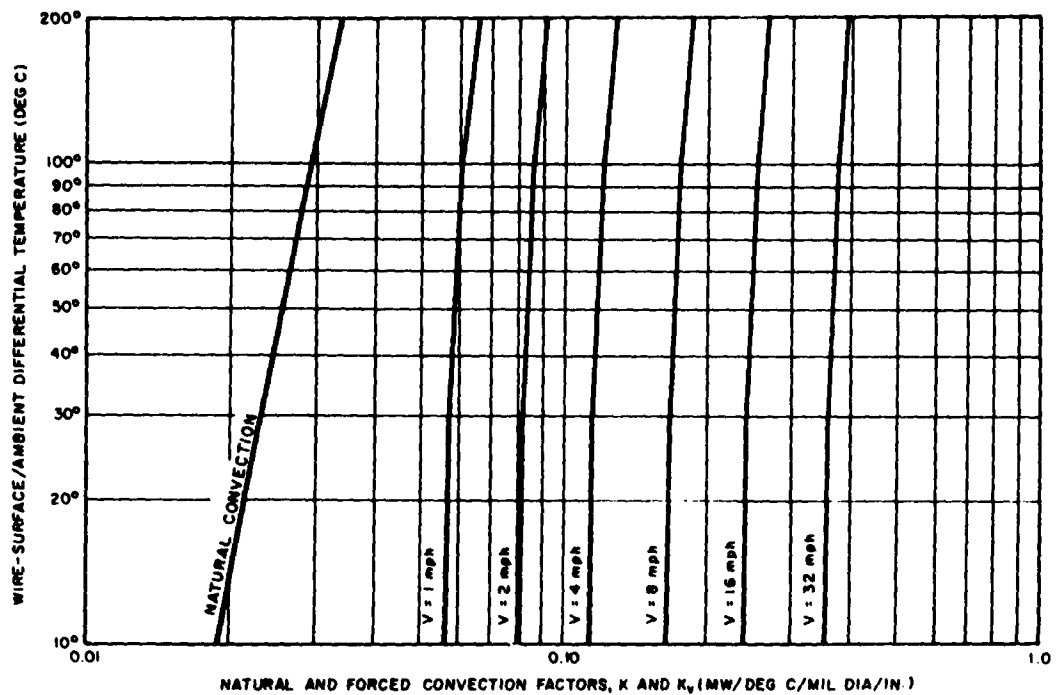

Figure A-7. Natural and Forced Convection Factors, K and K_v , for 250-Mil Diameter Wire

Curves in Figure A-7 plotted for the following test conditions:

- Smooth metal wires mounted horizontally at ambient conditions of 25 deg C and sea-level pressure.
- Wires heated internally due to I^2R losses.
- Given air velocities for air moving upward past the heated wires.

Source of data plotted in Figure A-7: Computations based on formulas and curve given in Ref. 3, p 259.

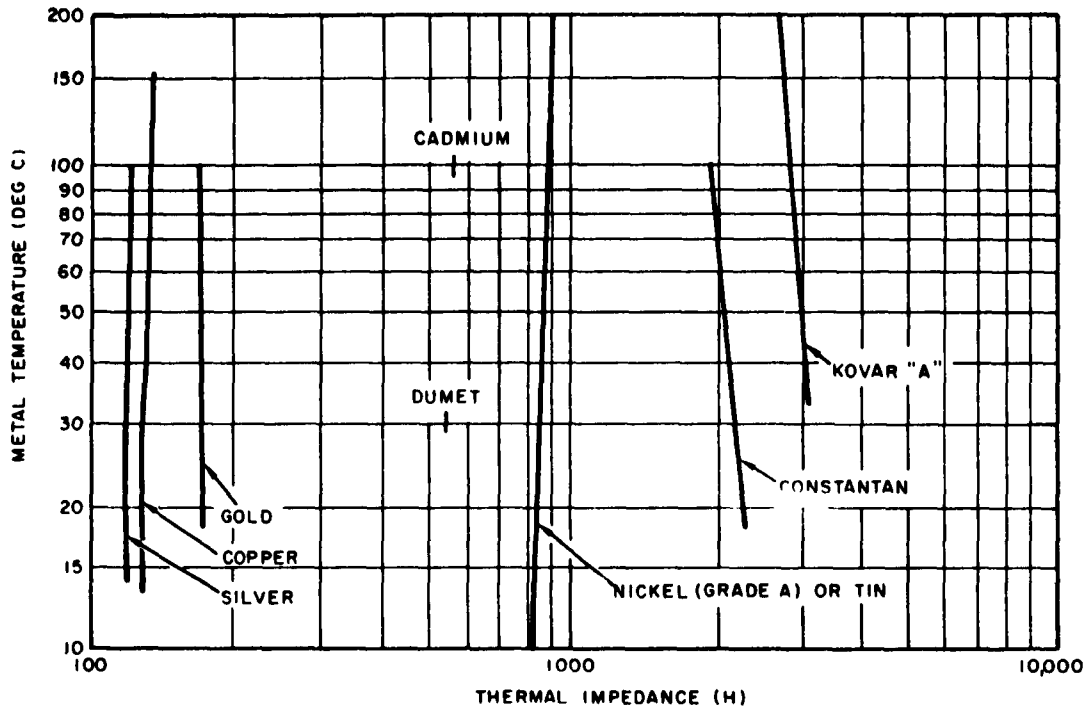

Figure A-8 Thermal Impedance, H, of Metals at Various Temperatures. (Temperature change per inch of length per milliwatt of heat flow through a rod of one-square-mil cross-sectional area. Also, $H = 120/(k)$ where (k) is the thermal conductivity of heat in calories per second transmitted through a plate one centimeter thick across an area of one square centimeter when the temperature difference is one degree Centigrade. Thermal impedance is affected by metal hardness and impurities.)

Sources of data plotted in Figure A-8

- (a) Chemical Engineers Handbook, 3rd Edition, P 456.
- (b) Technical Data Sheet 100 EB-9, Issue No. 3, The Carborundum Corporation, Latrobe, Pennsylvania (Kovar "A" Alloy).
- (c) General Electric (Cleveland Welds Plant), Cleveland, Ohio letter dated October 1, 1960 (Dumet Alloy, Copper Covered).

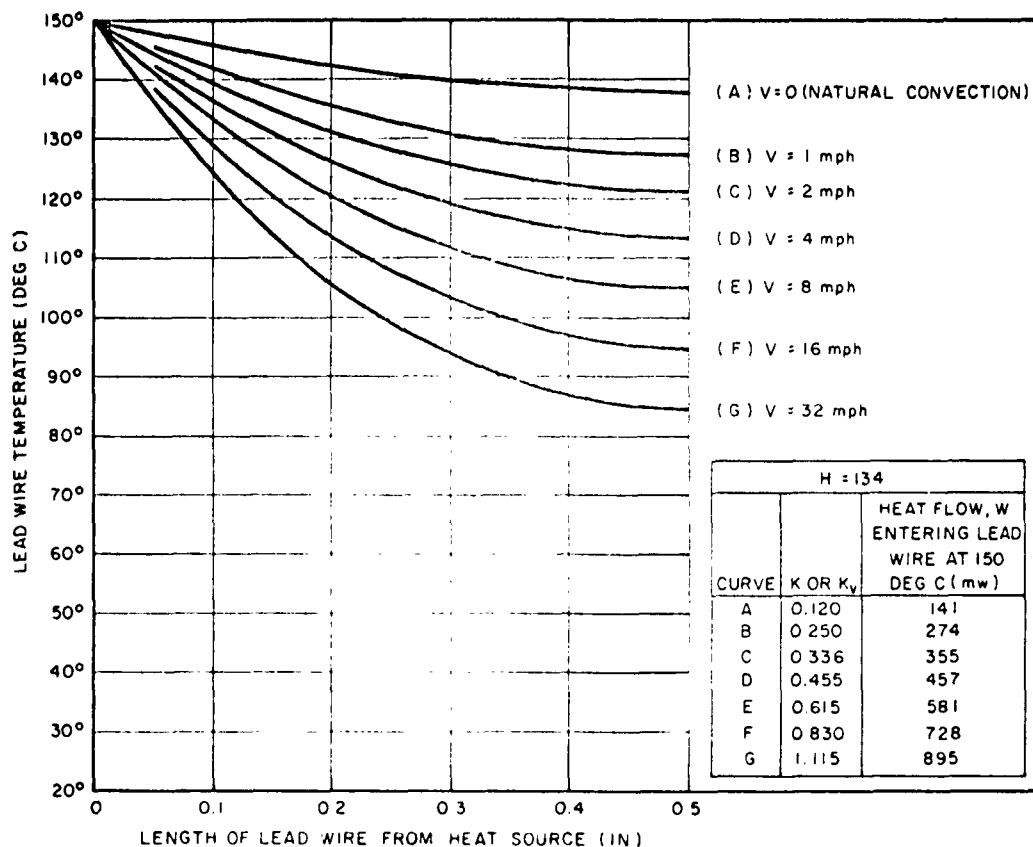

Figure A-9. Calculated Temperatures at Various Distances from a Heat Source Along a 0.5-In., 20-Mil Diameter Copper Lead Wire Under Natural and Forced Convection

Curves in Figure A-9 plotted for the following test conditions:

- (a) Lead wire horizontal and supported by one end in a heat source at 150 deg C within ambient conditions of 25 deg C and sea-level pressure.
- (b) Lead-wire surfaces with smooth clean finish.
- (c) Air velocities in upward direction.

Source of data plotted in Figure A-9: Computations based on Equations (3a) and (3c) of this report.

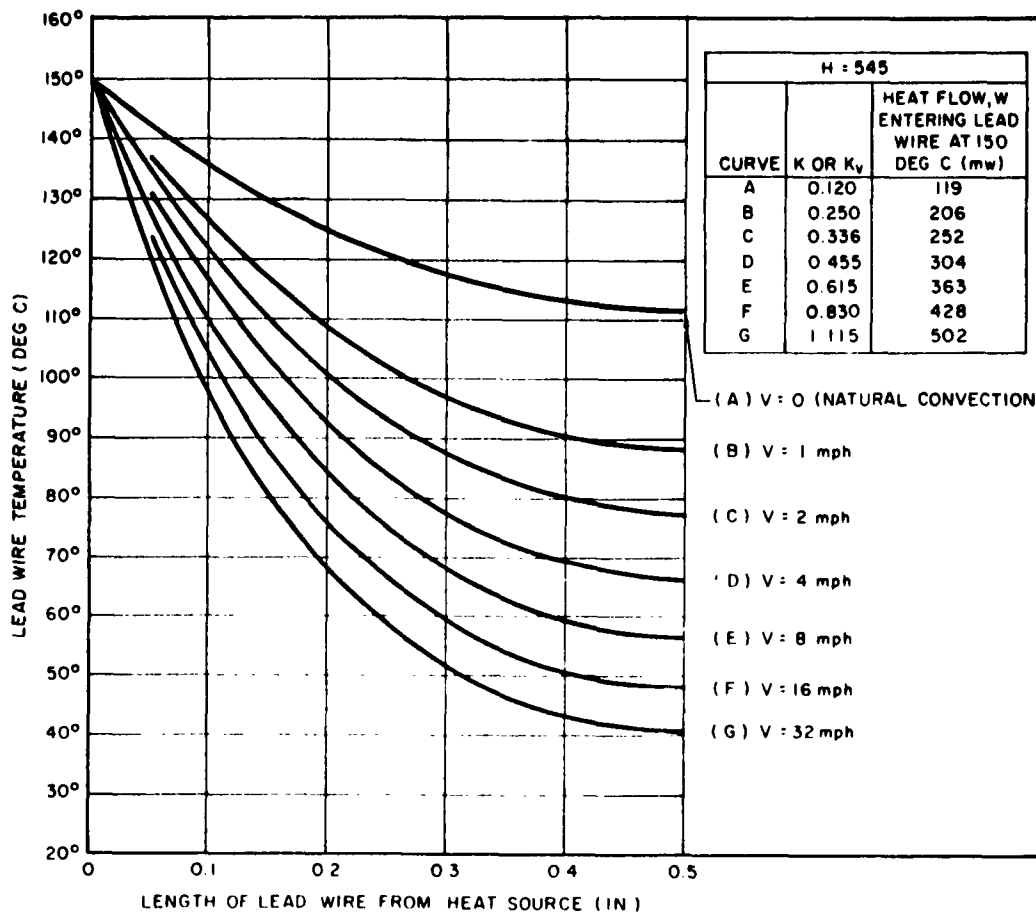

Figure A-10. Calculated Temperatures at Various Distances from a Heat Source Along a 0.5-In., 20-Mil Diameter Dumet Lead Wire Under Natural and Forced Convection

Curves in Figure A-10 plotted for the following test conditions:

- (a) Lead wire horizontal, and supported by one end in a heat source at 150 deg C within ambient conditions of 25 deg C and sea-level pressure.
- (b) Lead-wire surfaces with smooth clean finish.
- (c) Air velocities in upward direction.

Source of data plotted in Figure A-10: Computations based on Equations (3a) and (3c) of this report.

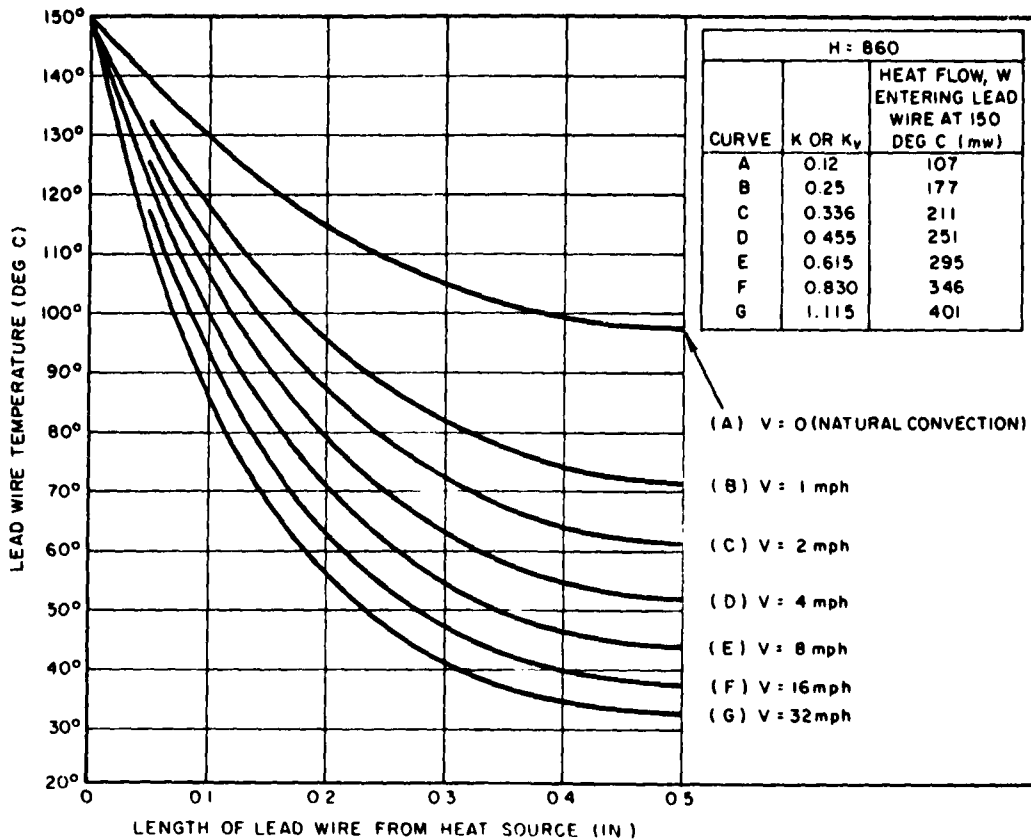

Figure A-11. Calculated Temperatures at Various Distances from a Heat Source Along a 0.5-In., 20-Mil Diameter Nickel Lead Wire Under Natural and Forced Convection

Curves in Figure A-11 plotted for the following test conditions:

- Lead wire horizontal and supported by one end in a heat source at 150 deg C within ambient conditions of 25 deg C and sea-level pressure.
- Lead-wire surfaces with smooth clean finish.
- Air velocities in upward direction.

Source of data plotted in Figure A-11: Computations based on Equations (3a) and (3c) of this report.

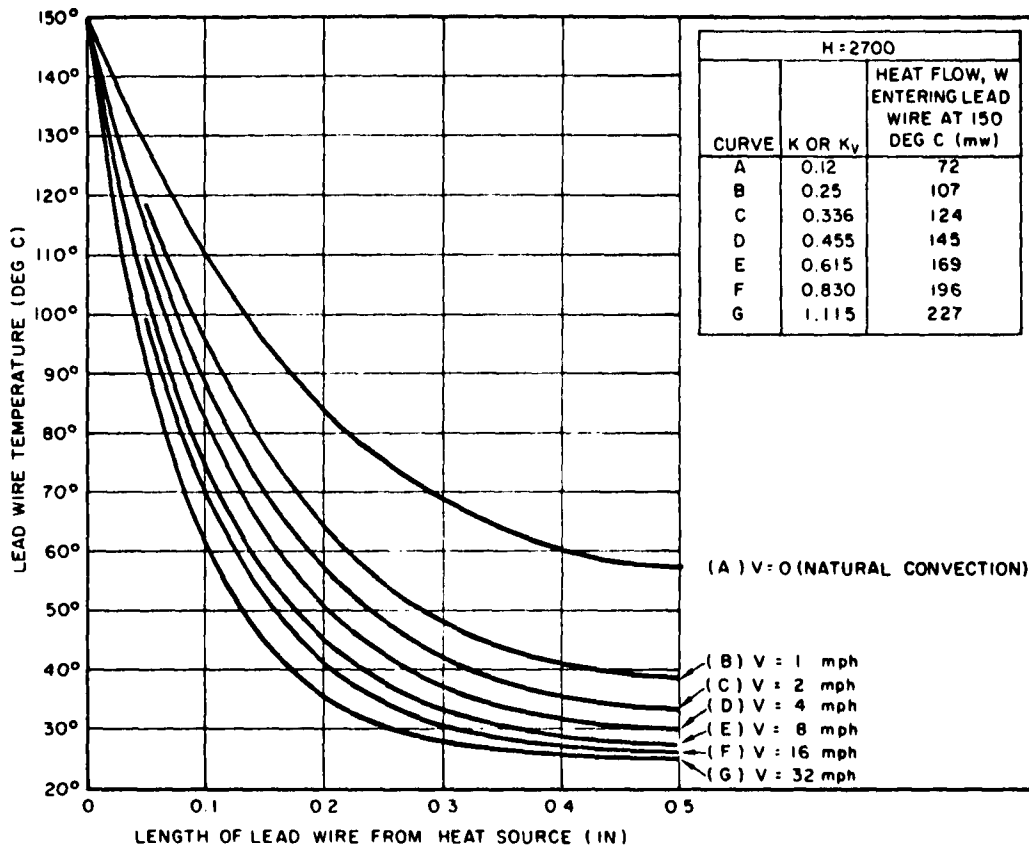

Figure A-12. Calculated Temperatures at Various Distances from a Heat Source Along a 0.5-In., 20-Mil Diameter Kovar Lead Wire Under Natural and Forced Convection

Curves in Figure A-12 plotted for the following test conditions:

- (a) Lead wire horizontal and supported by one end in a heat source at 150 deg C within ambient conditions of 25 deg C and sea-level pressure.
- (b) Lead-wire surfaces with smooth clean finish.
- (c) Air velocities in upward direction.

Source of data plotted in Figure A-12: Computations based on Equations (3a) and (3c) of this report.

Table A-1. Conversion Table for Convection Coefficients

$\frac{\text{BTU}}{\text{hr-ft}^2\text{-deg F}}$	$\frac{\text{mw}}{\text{in.}^2\text{-deg C}}$	$\text{mw/in.}^2/\text{deg C/mil dia}$
1	3.66	0.01152
0.273	1	0.00314
86.8	318	1

UNCLASSIFIED

Aerospace Corporation, El Segundo, California.
 HEAT DISSIPATION THROUGH DIODE LEAD
 WIRES UNDER STEADY-STATE CONDITIONS,
 Supp 1: HEAT DISSIPATION BY NATURAL OR
 FORCED CONVECTION, prepared by
 W. D. Buckman, October 1962. [34]p. incl. illus.
 (Report IDR-930(2121)-TN-1, Supp 1;
 DCAS-TN-61-19, Supp 1)
 (Contract AF 04(647)-169) Unclassified report

This report presents applicable theoretical considerations, mathematical relationships, and typical calculations for predicting steady-state heat flow from small-diameter wires, wire leads, and rods as a result of natural or forced convection occurring under given ambient conditions. The two specific cases of heat dissipation from wire leads which are considered are the heat flow resulting from the uniform heating which occurs within a given wire length due to I²R losses and from heat entering only one end of a lead wire.

UNCLASSIFIED

UNCLASSIFIED

Aerospace Corporation, El Segundo, California.
 HEAT DISSIPATION THROUGH DIODE LEAD
 WIRES UNDER STEADY-STATE CONDITIONS,
 Supp 1: HEAT DISSIPATION BY NATURAL OR
 FORCED CONVECTION, prepared by
 W. D. Buckman, October 1962. [34]p. incl. illus.
 (Report IDR-930(2121)-TN-1, Supp 1;
 DCAS-TN-61-19, Supp 1)
 (Contract AF 04(647)-169) Unclassified report

This report presents applicable theoretical considerations, mathematical relationships, and typical calculations for predicting steady-state heat flow from small-diameter wires, wire leads, and rods as a result of natural or forced convection occurring under given ambient conditions. The two specific cases of heat dissipation from wire leads which are considered are the heat flow resulting from the uniform heating which occurs within a given wire length due to I²R losses and from heat entering only one end of a lead wire.

UNCLASSIFIED

UNCLASSIFIED

Aerospace Corporation, El Segundo, California.
 HEAT DISSIPATION THROUGH DIODE LEAD
 WIRES UNDER STEADY-STATE CONDITIONS,
 Supp 1: HEAT DISSIPATION BY NATURAL OR
 FORCED CONVECTION, prepared by
 W. D. Buckman, October 1962. [34]p. incl. illus.
 (Report IDR-930(2121)-TN-1, Supp 1;
 DCAS-TN-61-19, Supp 1)
 (Contract AF 04(647)-169) Unclassified report

This report presents applicable theoretical considerations, mathematical relationships, and typical calculations for predicting steady-state heat flow from small-diameter wires, wire leads, and rods as a result of natural or forced convection occurring under given ambient conditions. The two specific cases of heat dissipation from wire leads which are considered are the heat flow resulting from the uniform heating which occurs within a given wire length due to I²R losses and from heat entering only one end of a lead wire.

UNCLASSIFIED

UNCLASSIFIED

Aerospace Corporation, El Segundo, California.
 HEAT DISSIPATION THROUGH DIODE LEAD
 WIRES UNDER STEADY-STATE CONDITIONS,
 Supp 1: HEAT DISSIPATION BY NATURAL OR
 FORCED CONVECTION, prepared by
 W. D. Buckman, October 1962. [34]p. incl. illus.
 (Report IDR-930(2121)-TN-1, Supp 1;
 DCAS-TN-61-19, Supp 1)
 (Contract AF 04(647)-169) Unclassified report

This report presents applicable theoretical considerations, mathematical relationships, and typical calculations for predicting steady-state heat flow from small-diameter wires, wire leads, and rods as a result of natural or forced convection occurring under given ambient conditions. The two specific cases of heat dissipation from wire leads which are considered are the heat flow resulting from the uniform heating which occurs within a given wire length due to I²R losses and from heat entering only one end of a lead wire.

UNCLASSIFIED

UNCLASSIFIED		UNCLASSIFIED	UNCLASSIFIED
--------------	--	--------------	--------------

UNCLASSIFIED		UNCLASSIFIED	UNCLASSIFIED
--------------	--	--------------	--------------