

UNCLASSIFIED

AD 274 209

*Reproduced
by the*

**ARMED SERVICES TECHNICAL INFORMATION AGENCY
ARLINGTON HALL STATION
ARLINGTON 12, VIRGINIA**



UNCLASSIFIED

NOTICE: When government or other drawings, specifications or other data are used for any purpose other than in connection with a definitely related government procurement operation, the U. S. Government thereby incurs no responsibility, nor any obligation whatsoever; and the fact that the Government may have formulated, furnished, or in any way supplied the said drawings, specifications, or other data is not to be regarded by implication or otherwise as in any manner licensing the holder or any other person or corporation, or conveying any rights or permission to manufacture, use or sell any patented invention that may in any way be related thereto.

CATALOGED BY ASTIA
AS AD NO.

274209

274 209



T.&A.M. REPORT NO. 214

ANALYSIS OF MISSILE LAUNCHERS

Part M₁

A Two Point Mass Moving on a Flexible Beam

by

C.C. Fretwell

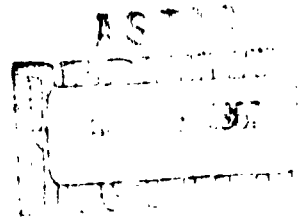

Sponsored by

Department of the Army

Rock Island Arsenal

DA-11-070-508-ORD-593

ORD. Proj. No. 517-01-002

CMS CODE 55-30.11.577

DEPARTMENT OF THEORETICAL AND APPLIED MECHANICS
UNIVERSITY OF ILLINOIS

Technical Report No. 214
on a research project entitled
Dynamics of Missile Launchers
Proj. Supervisor: M. Stippes

ANALYSIS OF MISSILE LAUNCHERS

Part M₁

A Two Point Mass Moving on a Flexible Beam

by

C. C. Fretwell

A Research Project of the
Department of Theoretical and Applied Mechanics
University of Illinois

Sponsored by

Department of the Army
Rock Island Arsenal
DA-11-070-508-ORD-593
ORD. Proj. No. 517-01-002
CMS CODE 55-30. 11. 577

University of Illinois
Urbana, Illinois
March, 1962

This is a part of the report on University of Illinois Project No. 46-22-60-304 "Launcher Dynamics Study". The analysis was performed under Contract No. DA-11-070-508-ORD-593 (ORD Proj. No. 517-01-002, CMS CODE 55-30.11.577). In part, the contract concerns the study of possible types of models for the representation of launching systems. This particular report contains an analysis of a rigid mass moving with two point contact on a spring supported flexible beam.

The program is under the technical supervision of Rock Island Arsenal (RIA), Rock Island, Illinois, and the administrative supervision of Chicago Ordnance District.

Respectfully submitted,
University of Illinois

A handwritten signature in black ink, appearing to read "M. Stippes". The signature is written in a cursive, slightly slanted style.

M. Stippes, Project Supervisor
Department of Theoretical and
Applied Mechanics

LAUNCHER DYNAMICS STUDY

Part M₁ ~~Phase~~ 1

(A Two Point Mass Moving on a Flexible Beam)

ABSTRACT

This report contains an approximate analysis of the motion of a flexible launcher rail which is supported by a flexible understructure and is loaded by a missile with two point contact which moves across the rail under the action of a prescribed thrust force. The launcher system is represented by a uniform flexible beam which is supported by linear springs and the missile is constrained to remain in contact with the beam. A pair of coupled integral equations are obtained which define the motion of the missile and a numerical technique of integration is developed for their solution. Finally some numerical results are presented to show the effects of some of the parameters on the motion of the missile and the rail.

TABLE OF CONTENTS

Chapter		Page
1	Development of Model	1
2	Analytical Development of the General Problem	3
3.	Numerical Solution of Equations	13
4	Numerical Results	19
Appendix A	Solution for Eq. (5)	32

List of Symbols

$R(t)$	Thrust force on the missile
W	Weight of the missile
m	Mass of the missile
θ_E	Angle of elevation of the rail
$\xi(t)$	Position coordinate of missile on the rail
k_1, k_2	Understructure spring rates
a, b	Locations of springs with respect to rear of rail
c	Total length of the rail
L	Length between shoes of the missile
L_1	Length from rear shoe to center of gravity of the missile
$P(t), Q(t)$	Contact forces between the missile and the rail
EI	Flexural rigidity of the rail
ρA	Mass per unit length of rail
J	Principal transverse moment of inertia of the missile
d_1	Length of guidance for two point contact
d_2	Total length of guidance

Other symbols are defined in the text when introduced.

CHAPTER 1

Development of Model

A typical straight rail missile launcher might appear as sketched in Fig. 1. We replace this with the model shown schematically in Fig. 2. In

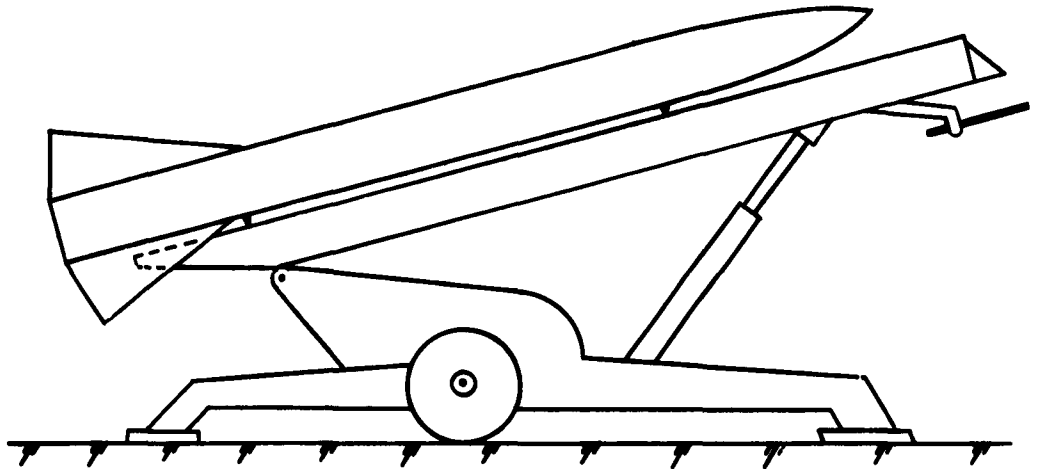

Figure 1

the undeformed state the beam is straight, uniform, and at an elevation angle θ_E . The x axis is taken along the undeformed axis of the beam and the y axis is

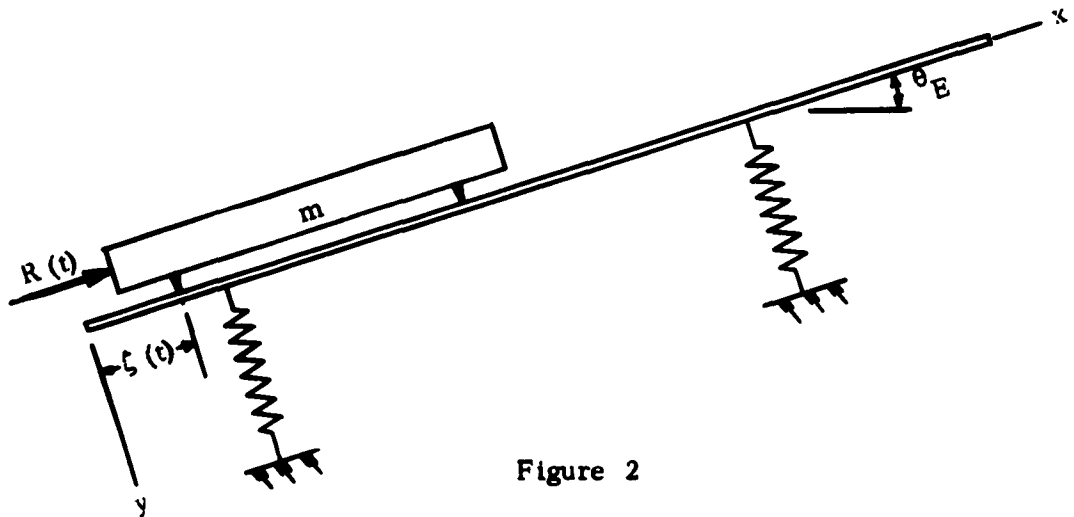

Figure 2

generally downward. The beam is supported at two points by linear springs and suitable constraints act to prevent axial motion of the beam.

We assume that the missile is a rigid mass which is forced to move along the beam under the action of the prescribed force $R(t)$. The motion of the mass along the beam is measured by the coordinate $\xi(t)$ as indicated in Fig. 2.

During the motion, two points of the missile are constrained to maintain contact with the rail. At some later time T_p , with $\xi(T_p) = d_2$, the rear shoe also leaves the rail and the missile is in flight. (It is possible for T_p and T_Q to be equal). We refer to T_p as the tipoff time and assume that all motion occurs in the xy -plane and that the entire system is initially at rest.

CHAPTER 2

Analytical Development of the General Problem

Consider the free body diagram shown in Fig. 3.

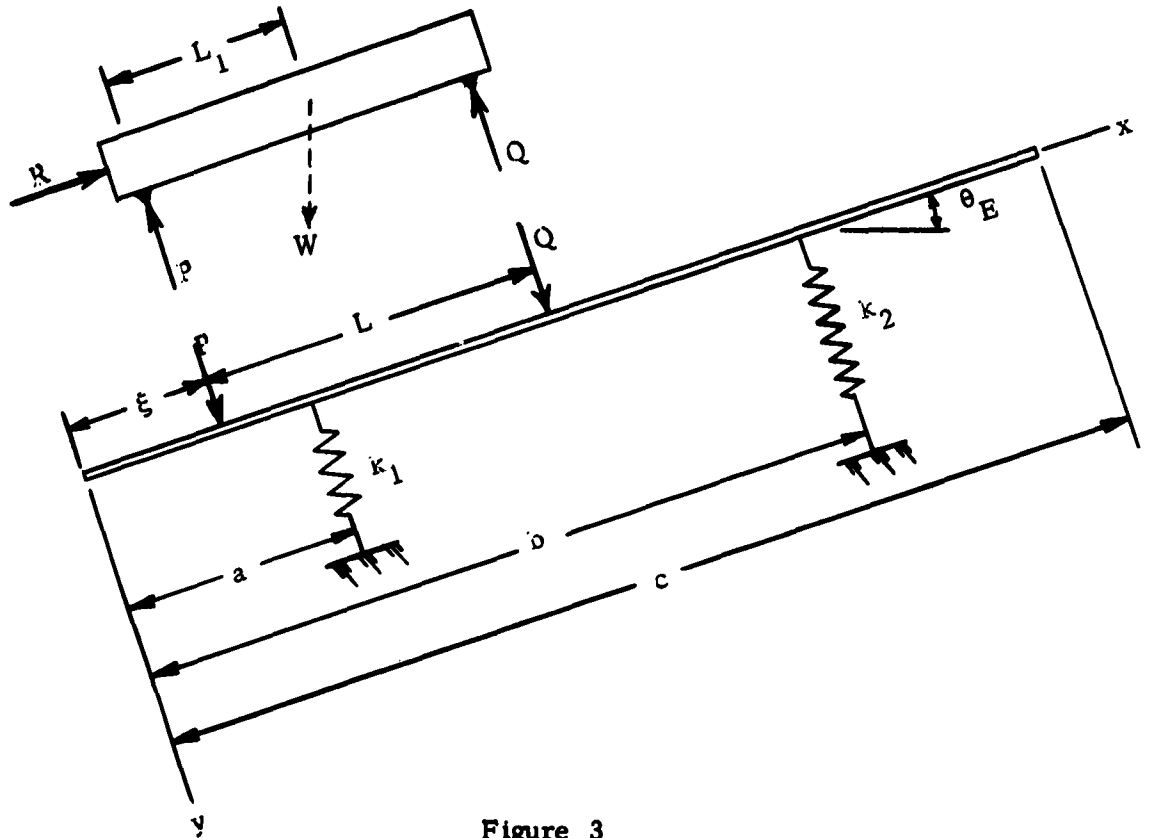

Figure 3

Referring to Fig. 4, let $\bar{\theta}$ be the rotation of the missile and \bar{y} the displacement of its center of mass. The equations of motion of the mass are

$$m \ddot{\bar{y}} = -P - Q + m g \cos \theta_E$$

$$J \ddot{\bar{\theta}} = L_1 P - (L - L_1) Q$$

If we let y_P and y_Q be the transverse displacements of the points of contact then for small displacements and rotations of the missile

$$\bar{y} \doteq \frac{L_1}{L} y_Q + \frac{L-L_1}{L} y_P$$

$$\bar{\theta} \doteq \frac{y_Q - y_P}{L}$$

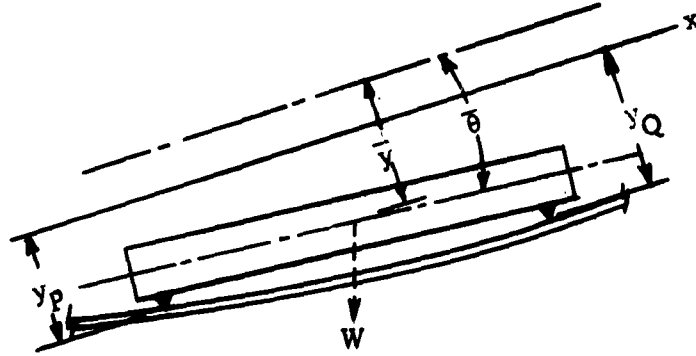

Figure 4

and therefore

$$P = m(\bar{g} h - J_3 \ddot{y}_P + J_1 \ddot{y}_Q) \quad (1)$$

$$Q = m(\bar{g} d + J_1 \ddot{y}_P - J_2 \ddot{y}_Q) \quad (2)$$

where

$$\frac{L_1}{L} = d \quad \frac{L-L_1}{L} = h \quad J_1 = \frac{J}{mL^2} - \frac{L_1(L-L_1)}{L^2}$$

$$J_2 = \frac{J}{mL^2} + \left(\frac{L_1}{L}\right)^2 \quad J_3 = \frac{J}{mL^2} + \left(\frac{L-L_1}{L}\right)^2 \quad \bar{g} = g \cos \theta_E$$

In order to obtain a good approximation of $\xi(t)$ we integrate the equation

$$m \ddot{\xi} = R ; \quad \dot{\xi}(0) = 0, \quad \xi(0) = \xi_0$$

where R is assumed to be a known function.

For the beam of Fig. 3, the equation of motion is

$$E I \frac{\partial^4 y(x, t)}{\partial x^4} + \rho A \frac{\partial^2 y(x, t)}{\partial t^2} = P \delta(\xi, x) + Q \delta(\xi + L, x) \quad (3)$$

where δ is the Dirac Delta or Unit Impulse function defined in the usual manner, i. e.

$$\int_{x_1}^{x_2} \delta(\xi, x) dx = \begin{cases} 0, & x_1 < x_2 < \xi \\ 1, & x_1 < \xi < x_2 \\ 0, & \xi < x_1 < x_2 \end{cases}$$

Since the system is initially at rest, the rail's initial velocity $y_t(x, 0)$ is zero and its initial displacement $y(x, 0)$ is due to the static loads produced by the mass m .

Assume that the solution of Eq. (3) may be written in the form

$$y(x, t) = \sum_{n=1}^{\infty} X_n(x) q_n(t) \quad ; \quad 0 \leq t \leq T_Q \quad (4)$$

where $X_n(x)$ is the n^{th} normal mode for the spring supported beam of Fig. 3, and each $q_n(t)$ may be regarded as a generalized coordinate. The set of functions $\{X_n(x)\}$ are the eigenfunctions of the equation

$$\frac{d^4 X_n(x)}{dx^4} - \lambda_n^4 X_n(x) = 0, \quad \lambda_n^4 = \frac{\rho A}{E I} \omega_n^2 \quad (5)$$

$$n = 1, 2, 3, \dots$$

subject to the appropriate boundary conditions for the beam. (The detailed solution of this equation is given in Appendix A). ω_n is the n^{th} natural frequency for the beam. The set of functions $\{X_n(x)\}$ also have the property

$$\int_0^c X_m(x) X_n(x) dx = \begin{cases} 0, & m \neq n \\ 1, & m = n \end{cases} \quad (6)$$

Having determined the functions $X_n(x)$ we can expand the Dirac functions in the following series

$$\delta(\xi, x) = \sum_{n=1}^{\infty} X_n(\xi) X_n(x) \quad (7)$$

$$\delta(\xi + L, x) = \sum_{n=1}^{\infty} X_n(\xi + L) X_n(x) \quad (8)$$

Using Eqs. (4), (7), and (8), Eq. (3) can be written

$$EI \sum_{n=1}^{\infty} X_n^{IV} q_n + \rho A \sum_{n=1}^{\infty} X_n \ddot{q}_n = P \sum_{n=1}^{\infty} X_n(\xi) X_n(x) + Q \sum_{n=1}^{\infty} X_n(\xi + L) X_n(x)$$

and with the use of Eq. (5) this expression becomes

$$\sum_{n=1}^{\infty} [\ddot{q}_n + \omega_n^2 q_n] X_n(x) = \sum_{n=1}^{\infty} \left[\frac{P}{\rho A} X_n(\xi) + \frac{Q}{\rho A} X_n(\xi + L) \right] X_n(x)$$

Upon comparing coefficients of the functions $\{X_n(x)\}$, we obtain

$$\ddot{q}_n + \omega_n^2 q_n = \frac{P}{\rho A} X_n(\xi) + \frac{Q}{\rho A} X_n(\xi + L), \quad n = 1, 2, 3, \dots \quad (9)$$

$0 \leq t \leq T_Q$

Since

$$y(x, 0) = \sum_{n=1}^{\infty} X_n(x) q_n(0)$$

$$y_t(x, 0) = \sum_{n=1}^{\infty} X_n(x) \dot{q}_n(0) = 0$$

it follows that the solutions of Eq. (9) are subject to the conditions

$$q_n(0) = \int_0^c X_n(x) y(x, 0) dx \quad (10)$$

$$\dot{q}_n(0) = 0 \quad (11)$$

(An expression for $q_n(0)$ is derived in Appendix A). Thus the solution of Eq. (9) becomes

$$q_n(t) = q_n(0) \cos \omega_n t + \frac{1}{\rho \Lambda \omega_n} \int_0^t \left\{ P(\tau) X_n[\xi(t)] + Q(\tau) X_n[\xi(t) + L] \right\} \sin \omega_n(t - \tau) d\tau$$

$n = 1, 2, 3, \dots$ (12)

Upon setting $x = \xi(t)$ in Eq. (4), we obtain the deflection of the point of contact of the rear shoe:

$$y_p(t) = y(\xi, t) = \sum_{n=1}^{\infty} X_n[\xi(t)] q_n(t) \quad (13)$$

Similarly for $x = \xi(t) + L$, we find

$$y_Q(t) = y(\xi + L, t) = \sum_{n=1}^{\infty} X_n[\xi(t) + L] q_n(t) \quad (14)$$

Then combining Eqs. (1), (2), and (14) and substituting this result into Eqs. (13) and (14) we obtain the pair of coupled integro-differential equations in the shoe deflections and their accelerations, i. e.

$$y_p(t) = F(t) + \int_0^t \left[K_1(t, \tau) + K_2(t, \tau) \ddot{y}_p(\tau) + K_3(t, \tau) \ddot{y}_Q(\tau) \right] d\tau$$

$0 \leq t \leq T_Q$ (15)

$$y_Q(t) = G(t) + \int_0^t \left[K_4(t, \tau) + K_5(t, \tau) \ddot{y}_p(\tau) + K_6(t, \tau) \ddot{y}_Q(\tau) \right] d\tau$$

$0 \leq t \leq T_Q$ (16)

where

$$F(t) = \sum_{n=1}^{\infty} X_n [\xi(t)] q_n(0) \cos \omega_n t$$

$$G(t) = \sum_{n=1}^{\infty} X_n [\xi(t) + L] q_n(0) \cos \omega_n t$$

$$K_1(t, \tau) = \frac{m \bar{g}}{\rho A} \sum_{n=1}^{\infty} \frac{X_n [\xi(t)] \sin \omega_n (t-\tau)}{\omega_n} \left\{ h X_n [\xi(\tau)] + d X_n [\xi(\tau) + L] \right\}$$

$$K_2(t, \tau) = \frac{m}{\rho A} \sum_{n=1}^{\infty} \frac{X_n [\xi(t)] \sin \omega_n (t-\tau)}{\omega_n} \left\{ J_1 X_n [\xi(\tau) + L] - J_3 X_n [\xi(\tau)] \right\}$$

$$K_3(t, \tau) = \frac{m}{\rho A} \sum_{n=1}^{\infty} \frac{X_n [\xi(t)] \sin \omega_n (t-\tau)}{\omega_n} \left\{ J_1 X_n [\xi(\tau)] - J_2 X_n [\xi(\tau) + L] \right\}$$

$$K_4(t, \tau) = \frac{m \bar{g}}{\rho A} \sum_{n=1}^{\infty} \frac{X_n [\xi(t) + L] \sin \omega_n (t-\tau)}{\omega_n} \left\{ h X_n [\xi(\tau)] + d X_n [\xi(\tau) + L] \right\}$$

$$K_5(t, \tau) = \frac{m}{\rho A} \sum_{n=1}^{\infty} \frac{X_n [\xi(t) + L] \sin \omega_n (t-\tau)}{\omega_n} \left\{ J_1 X_n [\xi(\tau) + L] - J_3 X_n [\xi(\tau)] \right\}$$

$$K_6(t, \tau) = \frac{m}{\rho A} \sum_{n=1}^{\infty} \frac{X_n [\xi(t) + L] \sin \omega_n (t-\tau)}{\omega_n} \left\{ J_1 X_n [\xi(\tau)] - J_2 X_n [\xi(\tau) + L] \right\}$$

Note that the $K_i(t, \tau)$ are non-symmetric kernels with the property $K_1(t, t) = 0$.

In order to put Eqs. (15) and (16) in a more tractable form, let

$$u_P(t) \equiv \ddot{y}_P(t)$$

$$u_Q(t) \equiv \ddot{y}_Q(t)$$

Then since the missile is initially at rest,

$$y_P(t) = \int_0^t (t - \tau) u_P(\tau) d\tau + y_P(0) \quad (21)$$

$$y_Q(t) = \int_0^t (t - \tau) u_Q(\tau) d\tau + y_Q(0) \quad (22)$$

in which $y_P(0)$ and $y_Q(0)$ are the initial displacements of the shoes and are computed from

$$y_P(0) = \sum_{n=1}^{\infty} q_n(0) X_n(\xi_0)$$

$$y_Q(0) = \sum_{n=1}^{\infty} q_n(0) X_n(\xi_0 + L)$$

Therefore Eqs. (15) and (16) can be written in the form

$$y_P(0) = F(t) + \int_0^t \left\{ K_1(t, \tau) + [K_2(t, \tau) - (t-\tau)] u_P(\tau) + K_3(t, \tau) u_Q(\tau) \right\} d\tau \quad (23)$$

$$y_Q(0) = G(t) + \int_0^t \left\{ K_4(t, \tau) + K_5(t, \tau) u_P(\tau) + [K_6(t, \tau) - (t-\tau)] u_Q(\tau) \right\} d\tau \quad (24)$$

These equations are to be solved for $u_P(t)$ and $u_Q(t)$. (In the next section we will present a numerical technique for obtaining appropriate solutions). The motion of the missile is then computed from Eqs. (21) and (22) and the motion of the beam can be obtained from Eqs. (4) after P and Q are determined from Eqs. (1) and (2) and $q_n(t)$ is found from Eq. (12).

Eqs. (23) and (24) are applicable when both shoes of the missile are in contact with the rail. When the front shoe loses contact with the rail, Q becomes and remains zero. For this case we set

$$y(x, t) = \sum_{n=1}^{\infty} X_n(x) q_n^*(t) \quad T_Q \leq t \leq T_P \quad (25)$$

obtaining

$$\ddot{q}_n^* + \omega_n^2 q_n^* = \frac{P^*}{\rho A} X_n(\xi) \quad (26)$$

$$n = 1, 2, 3, \dots$$

subject to the continuity conditions $q_n^*(T_Q) = q_n(T_Q)$ and $\dot{q}_n^*(T_Q) = \dot{q}_n(T_Q)$,
i. e. the displacements and velocities of the beam are continuous. Therefore,

$$q_n^*(t) = q_n(T_Q) \cos \omega_n(t-T_Q) + \frac{1}{\omega_n} \dot{q}_n^*(T_Q) \sin \omega_n(t-T_Q) \\ + \frac{1}{\rho A \omega_n} \int_{T_Q}^t P^*(\tau) X_n[\xi(\tau)] \sin \omega_n(t-\tau) d\tau \quad (27)$$

$n = 1, 2, 3, \dots$
 $T_Q \leq t \leq T_P$

where

$$P^* = m \frac{J_1 + h d}{J_2} [\bar{g} - \ddot{y}_P^*] \quad (28)$$

is found by setting $Q = 0$ in Eq. (2), solving for \ddot{y}_Q , and then substituting this result into Eq. (1).

Differentiating Eq. (13) twice we obtain

$$\ddot{y}_P(t) = \sum_{n=1}^{\infty} [\ddot{X}_n(\xi) q_n(t) + 2\dot{X}_n(\xi) \dot{q}_n(t) + X_n(\xi) \ddot{q}_n(t)] \\ 0 \leq t \leq T_Q$$

and similarly, from Eq. (25) after setting $x = \xi(t)$

$$\ddot{y}_P^*(t) = \sum_{n=1}^{\infty} [\ddot{X}_n(\xi) q_n^*(t) + 2\dot{X}_n(\xi) \dot{q}_n^*(t) + X_n(\xi) \ddot{q}_n^*(t)] \\ T_Q \leq t \leq T_P$$

If we set $t = T_Q$ in each of these equations and subtract, we find

$$\ddot{y}^*_P(T_Q) = \ddot{y}_P(T_Q) + Q(T_Q) \frac{\sum_{n=1}^{\infty} X_n[\xi(T_Q)] \left\{ J_1 X_n[\xi(T_Q)] - J_2 X_n[\xi(T_Q) + L] \right\}}{\rho A J_2 + m(J_1 + h d) \sum_{n=1}^{\infty} \left\{ X_n[\xi(T_Q)] \right\}^2} \quad (29)$$

where use has been made of Eqs. (1), (2), (9), (26), and (28) to simplify the result.

In Eq. (25) we now substitute $\xi(t)$ for x and proceed as before to obtain the displacement of the rear shoe,

$$y^*_P(t) = F^*(t) + \int_{T_P}^t [K^*_1(t, \tau)] [\bar{g} - \ddot{y}^*_P(\tau)] d\tau \quad (30)$$

$T_Q < t < T_P$

where

$$F^*(t) = \sum_{n=1}^{\infty} \left\{ \frac{\dot{q}_n(T_Q)}{\omega_n} \sin \omega_n(t - T_Q) + q_n(T_Q) \cos \omega_n(t - T_Q) \right\} X_n[\xi(t)]$$

$$K^*_1(t, \tau) = m \frac{J_1 + h d}{\rho A J_2} \sum_{n=1}^{\infty} \frac{X_n[\xi(t)] X_n[\xi(\tau)]}{\omega_n} \sin \omega_n(t - \tau)$$

($K^*_1(t, \tau)$ is also a non-symmetric kernel with the property $K^*_1(t, t) = 0$).

If we now set

$$u^*_P(t) = \ddot{y}^*_P(t)$$

then upon integrating,

$$y^*_P(t) = (t - T_Q) \left[\dot{y}_P(T_Q) + \frac{1}{2} (t - T_Q) \bar{g} \right] + y_P(T_Q) - \int_{T_Q}^t (t - \tau) [\bar{g} - u^*_P(\tau)] d\tau$$

Therefore Eq. (30) can be written in the form

$$(t - T_Q) \left[\dot{y}_P(T_Q) + \frac{1}{2} (t - T_Q) \bar{g} \right] + y_P(T_Q) = F^*(t) + \int_{T_Q}^t [K^*_1(t, \tau) + (t - \tau)] [\bar{g} - u^*_P(\tau)] d\tau \quad (31)$$

$T_Q < t < T_P$

For the condition of only the rear shoe in contact with the rail we obtain a single integral equation which we must solve for $\bar{g} - u_p^*(t)$. (In the next section we will present a numerical technique for obtaining appropriate solutions). The motion of the system is now computed as before except that the determination of u_Q is replaced by the condition $Q = 0$.

CHAPTER 3

Numerical Solution of Equations

An approximate solution of the equations of motion can be obtained in the following manner. For definiteness, we suppose the thrust curve is as shown in Fig. 5.

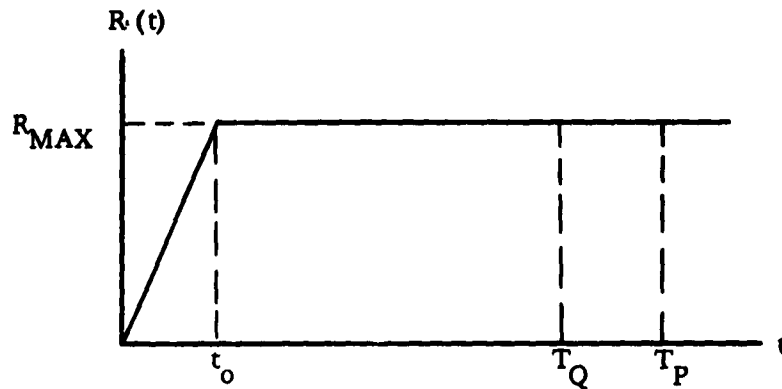

Figure 5

If t_0 is the thrust buildup time and R_{MAX} is the value of $R(t)$ at t_0 , then

$$0 \leq t \leq t_0 ; \quad \xi = \frac{R_{MAX}}{m t_0} \frac{t^3}{6} + \xi_0$$

$$t_0 \leq t ; \quad \xi = \frac{R_{MAX}}{2m} t(t - t_0) + \frac{R_{MAX}}{6m} t_0^2 + \xi_0$$

and

$$T_Q = \frac{t_0}{2} + \sqrt{\frac{m}{2} \frac{d_1 - \xi_0}{R_{MAX}} - \frac{t_0^2}{12}}$$

$$T_P = \frac{t_0}{2} + \sqrt{\frac{m}{2} \frac{d_2 - \xi_0}{R_{MAX}} - \frac{t_0^2}{12}}$$

Now we divide the interval $0 \leq t \leq T_Q$ into M equal intervals of time $\Delta t = \frac{T_Q}{M}$ in length. Observing that $u_p(0) = u_Q(0) = 0$, $K_1(t_1 t) = 0$, and applying

the trapezoidal rule of integration, we obtain the following approximations for Eqs. (15) and (16).

$$\begin{aligned}
 \frac{y_p(0) - F(N \Delta t)}{\Delta t} &= \frac{1}{2} K_1(N \Delta t, 0) \quad 2 \leq N \leq M \\
 &+ \sum_{j=1}^{N-2} \left\{ K_1(N \Delta t, j \Delta t) + [K_2(N \Delta t, j \Delta t) - (N-j) \Delta t] u_p(j \Delta t) \right. \\
 &\quad \left. + K_3(N \Delta t, j \Delta t) u_Q(j \Delta t) \right\} \\
 &+ K_1[N \Delta t, (N-1) \Delta t] + \left\{ K_2[N \Delta t, (N-1) \Delta t] - \Delta t \right\} u_p[(N-1) \Delta t] \\
 &\quad + K_3[N \Delta t, (N-1) \Delta t] u_Q[(N-1) \Delta t]
 \end{aligned} \tag{32}$$

$$\begin{aligned}
 \frac{y_Q(0) - G(N \Delta t)}{\Delta t} &= \frac{1}{2} K_4(N \Delta t, 0) \quad 2 \leq N \leq M \\
 &+ \sum_{j=1}^{N-2} \left\{ K_4(N \Delta t, j \Delta t) + K_5(N \Delta t, j \Delta t) u_p(j \Delta t) \right. \\
 &\quad \left. + [K_6(N \Delta t, j \Delta t) - (N-j) \Delta t] u_Q(j \Delta t) \right\} \\
 &+ K_4[N \Delta t, (N-1) \Delta t] + K_5[N \Delta t, (N-1) \Delta t] u_p[(N-1) \Delta t] \\
 &\quad + \left\{ K_6[N \Delta t, (N-1) \Delta t] - \Delta t \right\} u_Q[(N-1) \Delta t]
 \end{aligned} \tag{33}$$

We begin the numerical process with $N = 2$ and then use successive substitutions to carry out the numerical integration to $N = M$. The advantage of using this form for the equations is that they are recursive in nature and therefore do not involve the inversion of a matrix for their solution. The bulk of the computations will be in computing the kernels $K_i(t, \tau)$ at the various sub-intervals of time.

The sums on j create no large amount of computation because the kernels can be rewritten so that the corresponding values at $j + 1$ are obtained from those at j by adding a term.

Because $K_1(t, t) = 0$, we use Eqs. (32) and (33) to compute $u_p(t)$ and $u_Q(t)$ only up to $T_Q - \Delta t$. In order to compute the values at T_Q a second degree polynomial is fitted to the preceding three values resulting in the formulae

$$u_p(T_Q) \doteq u_p[(M-3)\Delta t] + 3 \left\{ u_p[(M-1)\Delta t] - u_p[(M-2)\Delta t] \right\}$$

$$u_Q(T_Q) \doteq u_Q[(M-3)\Delta t] + 3 \left\{ u_Q[(M-1)\Delta t] - u_Q[(M-2)\Delta t] \right\}$$

The main factor influencing the choice of the number of subdivisions $M = \frac{T_Q}{\Delta t}$ is the factor $\sin \omega_n(t - \tau) = \sin \omega_n(N-j)\Delta t$ in each kernel. In numerical computations we have to truncate the series expressions at some value $n = p$. Then the factor $\sin \omega_p(t - \tau)$ could range over many complete cycles in the interval $0 \leq t \leq T_Q$. $\omega_p(n-j)\Delta t$ changes by the amount $\omega_p \Delta t$ with each increase in j and prudence demands that, at the very least, $\omega_p \Delta t < \frac{\pi}{2}$. (In the computations made, the worst case had five points per cycle in the third mode, i. e. $p = 3$ was used).

For Eq. (31) we divide the interval $T_Q \leq t \leq T_P$ into M^* equal intervals of time $\Delta t^* = \frac{T_P - T_Q}{M^*}$ in length. Observing that $K_1^*(t, t) = 0$, the trapezoidal rule of integration applied to Eq. (31) yields

$$\begin{aligned}
& \frac{N^* \Delta t^* \left[\dot{y}_p(T_Q) + \frac{1}{2} N^* \Delta t^* \bar{g} \right] + y_p(T_Q) - F^*(T_Q + N^* \Delta t^*)}{\Delta t^*} = \\
& \hspace{20em} 2 \leq N^* \leq M^* \\
& = \frac{1}{2} \left[K^*_1(T_Q + N^* \Delta t^*, T_Q) + N^* \Delta t^* \right] \left[\bar{g} - u^*_p(T_Q) \right] \\
& \quad + \sum_{j=1}^{N^*-2} \left[K^*_1(T_Q + N^* \Delta t^*, T_Q + j \Delta t^*) + (N^*-j) \Delta t^* \right] \left[\bar{g} - u^*_p(T_Q + j \Delta t^*) \right] \\
& \quad + \left\{ K^*_1 \left[T_Q + N^* \Delta t, T_Q + (N^*-1) \Delta t^* \right] + \Delta t^* \right\} \left\{ \bar{g} - u^*_p \left[T_Q + (N^*-1) \Delta t^* \right] \right\}
\end{aligned} \tag{34}$$

where we have set $t = T_Q + N^* \Delta t^*$. We begin the numerical process with $N^* = 2$ and carry out the same resubstitution process that was used in Eqs. (32) and (33). Since Eq. (34) can be used only up to $T_p - \Delta t^*$, we again compute the value at T_p from a second degree polynomial approximation. The time interval Δt^* is chosen comparable to Δt by taking M^* as the next integer larger than $(T_p - T_Q)/M T_Q$.

Having determined the values of u_p , u_Q , and $\bar{g} - u^*_p$ at each of the sub-interval points, we are in a position to determine values for the following parameters. Each of the indicated integrations may be carried out using Simpson's rule for example, and only p normal modes are considered in the series expansion.

For $\bar{\theta}$, the pitch angle of the missile

$$\bar{\theta}(t) = \begin{cases} \bar{\theta}(0) + \frac{1}{L} \int_0^t (t-\tau) [u_Q(\tau) - u_p(\tau)] d\tau, & 0 \leq t \leq T_Q \\ (t - T_Q) \dot{\bar{\theta}}(T_Q) + \bar{\theta}(T_Q) + \frac{d}{j_2 L} \int_{T_Q}^t (t-\tau) [\bar{g} - u^*_p(\tau)] d\tau, & T_Q \leq t \leq T_p \end{cases}$$

For $\dot{\bar{\theta}}$, the pitch velocity of the missile

$$\dot{\bar{\theta}}(t) = \begin{cases} \frac{1}{L} \int_0^t [u_Q(\tau) - u_P(\tau)] d\tau & , 0 \leq t \leq T_Q \\ \dot{\bar{\theta}}(T_Q) + \frac{d}{J_2 L} \int_{T_Q}^t [\bar{g} - u_P^*(\tau)] d\tau & , T_Q \leq t \leq T_P \end{cases}$$

For \bar{y} , the center of gravity displacement of the missile

$$\bar{y}(t) = \begin{cases} \bar{y}(0) + \int_0^t (t-\tau) [h u_P(\tau) + d u_Q(\tau)] d\tau, & 0 \leq t \leq T_Q \\ (t-T_Q) \dot{\bar{y}}(T_Q) + \bar{y}(T_Q) + \frac{1}{2} (t-T_Q)^2 \bar{g} - \frac{J_1 h d}{J_2 T_Q} \int_{T_Q}^t (t-\tau) [g - u_P^*(\tau)] d\tau, & T_Q \leq t \leq T_P \end{cases}$$

For $\dot{\bar{y}}$, the center of gravity transverse velocity of the missile

$$\dot{\bar{y}}(t) = \begin{cases} \int_0^t [h u_P(\tau) + d u_Q(\tau)] d\tau & , 0 \leq t \leq T_Q \\ \dot{\bar{y}}(T_Q) + (t - T_Q) \bar{g} - \frac{J_1 + h d}{J_2 T_Q} \int_{T_Q}^t [\bar{g} - u_P^*(\tau)] d\tau, & T_Q \leq t \leq T_P \end{cases}$$

For y_{TIP} , the tip displacement of the rail

$$y_{TIP}(t) = \begin{cases} \sum_{n=1}^P X_n(c) q_n(t) & , 0 \leq t \leq T_Q \\ \sum_{n=1}^P X_n(c) q_n^*(t) & , T_Q \leq t \leq T_P \end{cases}$$

For \dot{y}_{TIP} , the tip transverse velocity of the rail

$$\dot{y}_{TIP}(t) = \begin{cases} \sum_{n=1}^P X_n(c) \dot{q}_n(t) & , 0 \leq t \leq T_Q \\ \sum_{n=1}^P X_n(c) \dot{q}_n^*(t) & , T_Q \leq t \leq T_P \end{cases}$$

For y'_{TIP} , the tip angular displacement of the rail

$$y'_{\text{TIP}}(t) = \begin{cases} \sum_{n=1}^p X'_n(c) q_n(t) & , \quad 0 \leq t \leq T_Q \\ \sum_{n=1}^p X'_n(c) q_n^*(t) & , \quad T_Q \leq t \leq T_P \end{cases}$$

For \dot{y}'_{TIP} , the tip angular velocity of the beam

$$\dot{y}'_{\text{TIP}}(t) = \begin{cases} \sum_{n=1}^p X'_n(c) \dot{q}_n(t) & , \quad 0 \leq t \leq T_Q \\ \sum_{n=1}^p X'_n(c) \dot{q}_n^*(t) & , \quad T_Q \leq t \leq T_P \end{cases}$$

CHAPTER 4
Numerical Results

Table 1 gives the nominal values of the parameters specifying a particular system.

Table 1

<u>Parameter</u>	<u>Description</u>	<u>Value</u>
k_1	Rear spring support	∞
k_2	Front spring support	9, 230 lb/in
a	x coordinate of k_1	46 in
b	x coordinate of k_2	160 in
c	Total rail length	328 in
EI	Flexural rigidity of rail	$54 \times 10^3 \text{ lb-in}^2$
ρA	Mass per unit length of rail	$0.018325 \text{ lb-sec}^2/\text{in-in}$
θ_E	Angle of elevation of rail	0. 8 rad
L	Length between shoes of missile	144 in
L_1	Length from rear shoe to center of gravity of the missile	100 in
W	weight of missile	4150 lb
J	Principal transverse moment of inertia of missile	$41, 200 \text{ lb-sec}^2\text{in}^2/\text{in}$
ξ_0	x coordinate of rear shoe at $t = 0$	4 in
R_{MAX}	Maximum thrust force on missile	124, 686. 6 lb
d_1	Length of guidance for two shoe contact	180 in
d_2	Total length of guidance	180 in
t_0	Thrust build-up time	0. 100 sec

The following variations of the nominal values were also considered

Table 2

<u>System</u>	<u>Parameters Changed</u>
Soft beam	$E I = \frac{1}{2} (E I)_{\text{nom}}$
Stiff beam	$E I = \frac{1}{2} (E I)_{\text{nom}}$
Soft spring	$k_2 = \frac{1}{2} (k_2)_{\text{nom}}$
Stiff spring	$k_2 = 10 (k_2)_{\text{nom}}$
Short overhang	$b = (c)_{\text{nom}}$ $k_2 = \left(\frac{b-a}{c}\right)^2_{\text{nom}} (k_2)_{\text{nom}}$
Short tipoff	$d_2 = 1.01 (d_1)_{\text{nom}}$
Long tipoff	$d_2 = (d_1)_{\text{nom}} + (L)_{\text{nom}}$
Light beam	$\rho A = \frac{1}{2} (\rho A)_{\text{nom}}$
Heavy beam	$\rho A = 2 (\rho A)_{\text{nom}}$

For the nominal system results were computed using one, two and three modes. The results for $\bar{\theta}$ and $\dot{\bar{\theta}}$ are shown in Figs 6 and 7. For the parameters involved, two modes apparently furnish values as accurate as three.

Figs 8 through 15 present graphically the results obtained for the systems given in Tables 1 and 2. Three modes were used in all of the computations. The effect of long and short tipoff are given in Table 3.

Table 3

	Nominal Short Tipoff ($T_p = 222.7$)	Long Tipoff ($T_p = 283.1$)
$\bar{\theta}$	3.300	10.320
$\dot{\theta}$	24.960	199.210
\bar{y}	0.061	0.142
\dot{y}	0.944	1.742
y_{TIP}	0.074	.057
\dot{y}_{TIP}	0.342	-0.513
y'_{TIP}	3.340	2.670
\dot{y}'_{TIP}	4.690	2.770

The natural frequencies of the unloaded beams in the above systems are also of interest. These are presented for the first three modes in Table 4.

Table 4

<u>System</u>	<u>Natural Frequency, cycles/sec</u>		
	f_1	f_2	f_3
Nominal	4.6	52.6	156.3
Soft beam	4.6	37.7	110.5
Stiff beam	4.7	73.8	221.0
Soft spring	3.3	52.2	156.3
Stiff spring	13.0	58.9	156.3
Short overhang	4.7	52.1	156.3
Short tipoff	4.6	52.6	156.3
Long tipoff	4.6	52.6	156.3
Light beam	6.6	74.3	221.0
Heavy beam	3.3	37.2	110.5

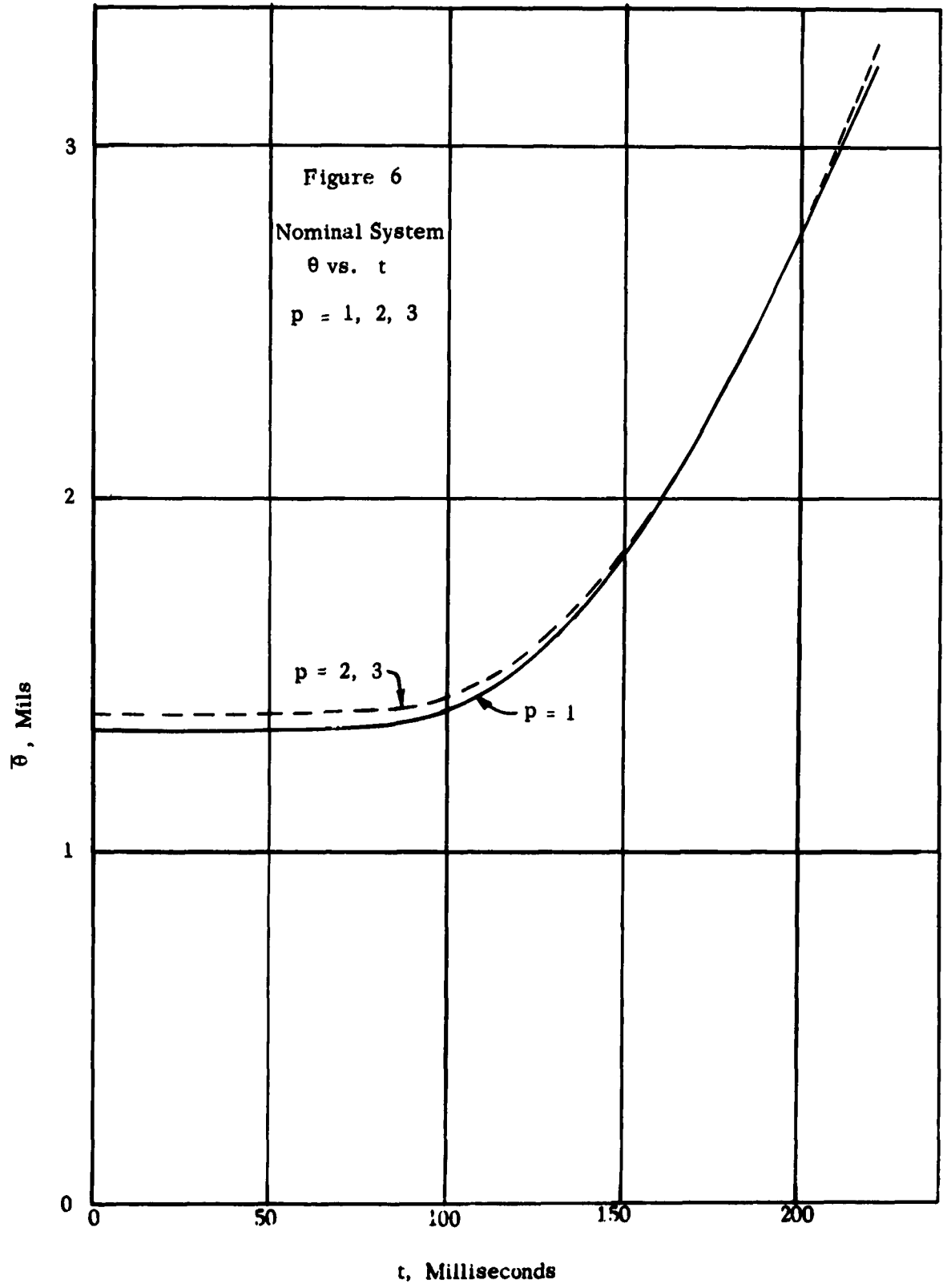

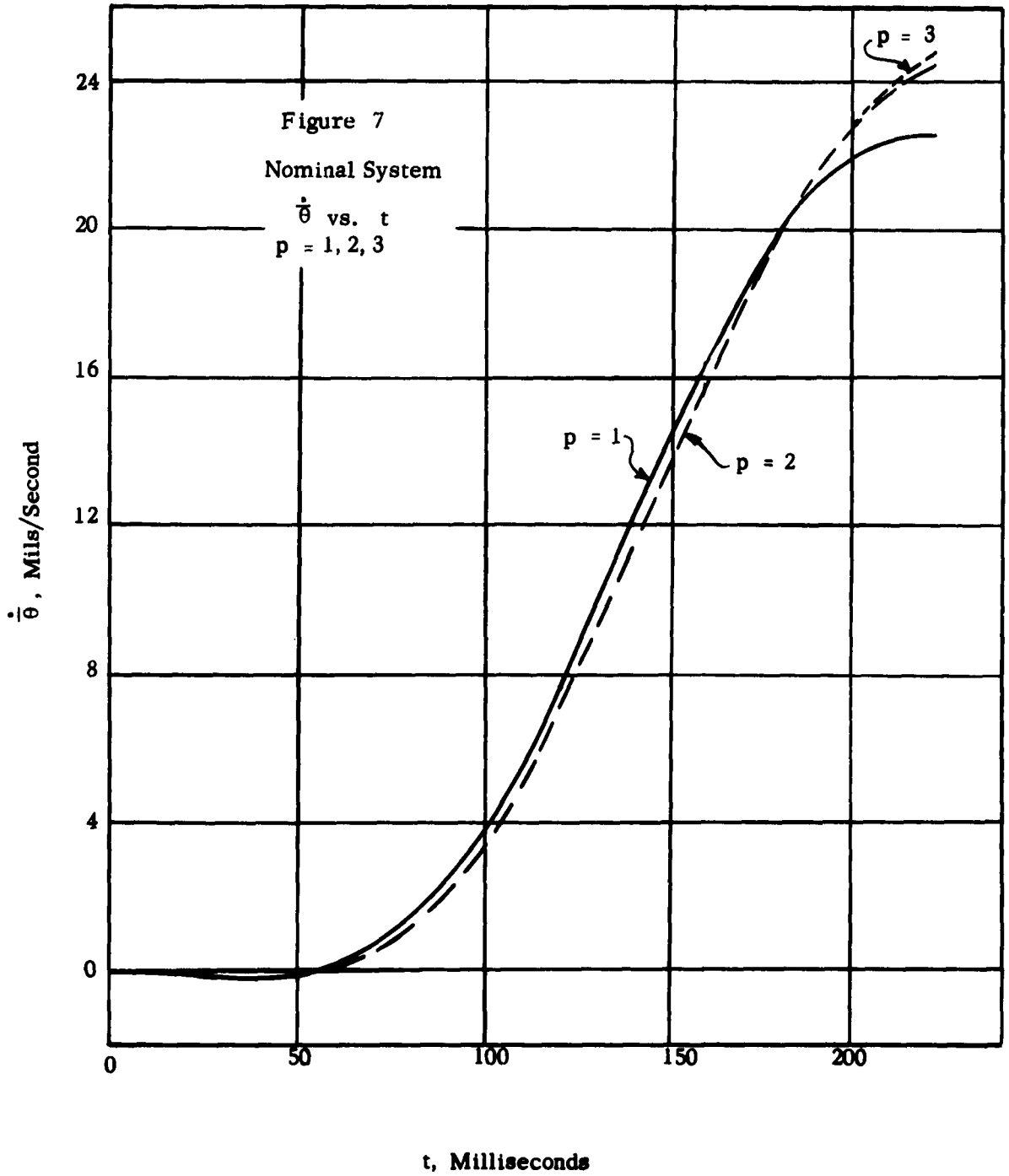

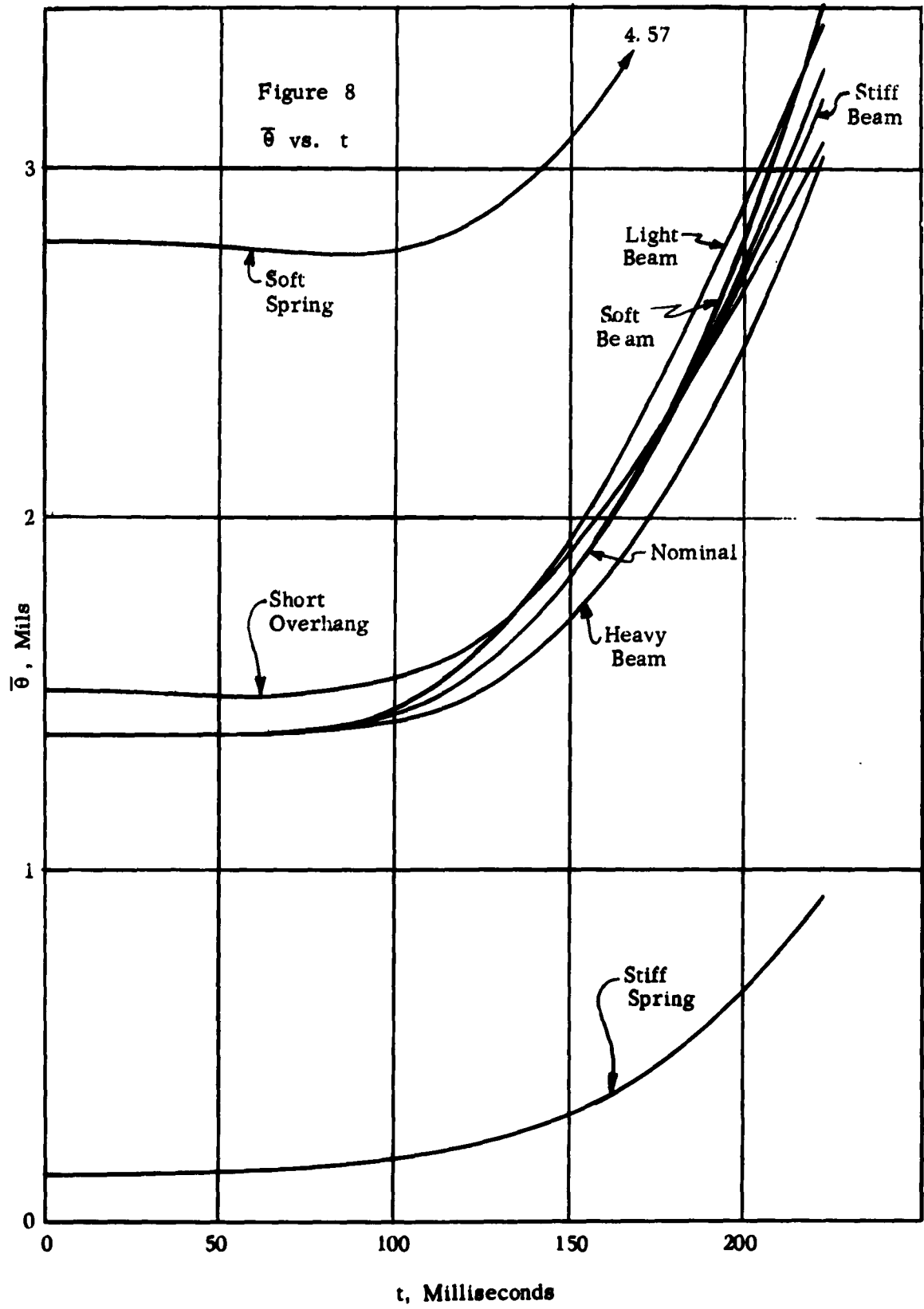

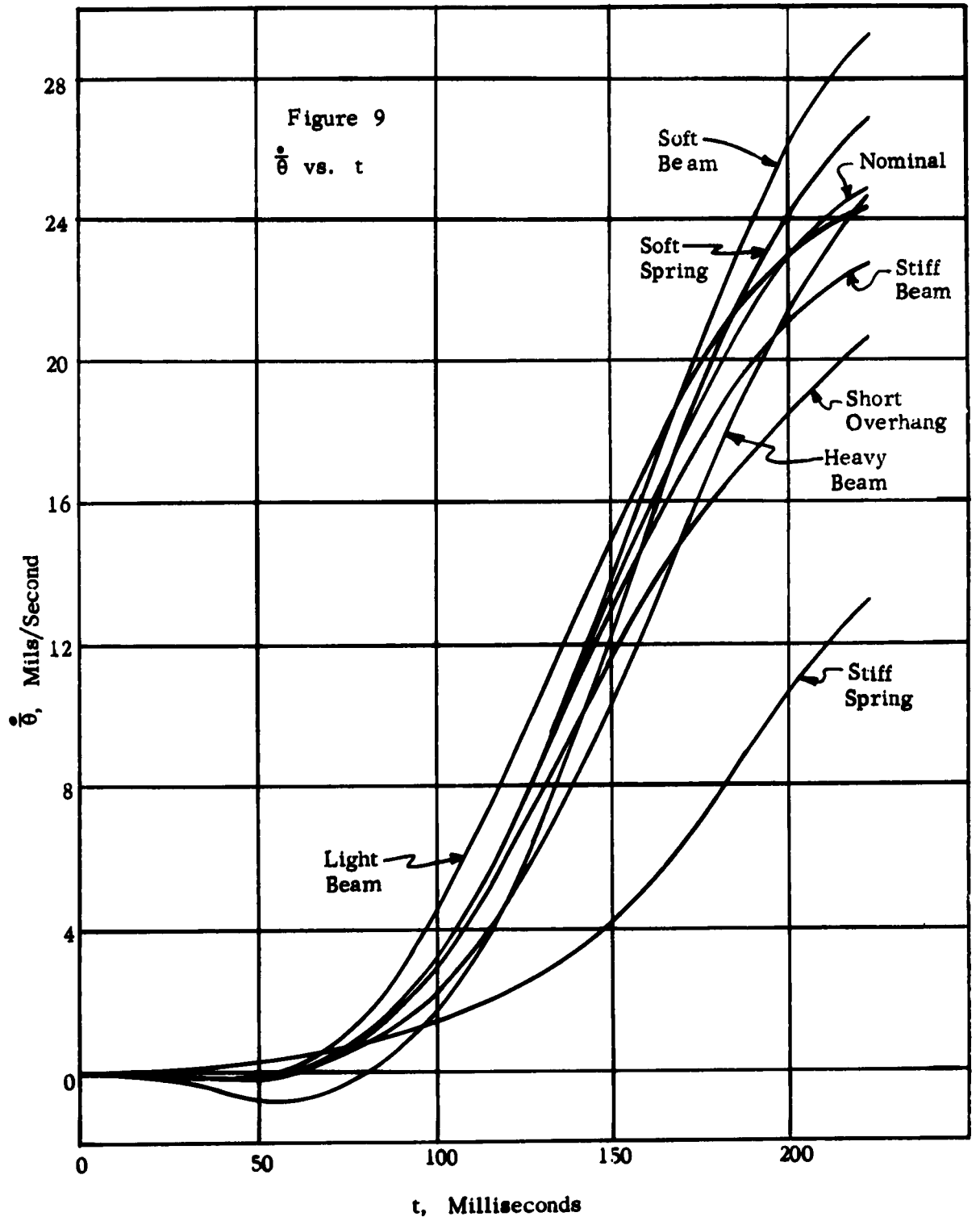

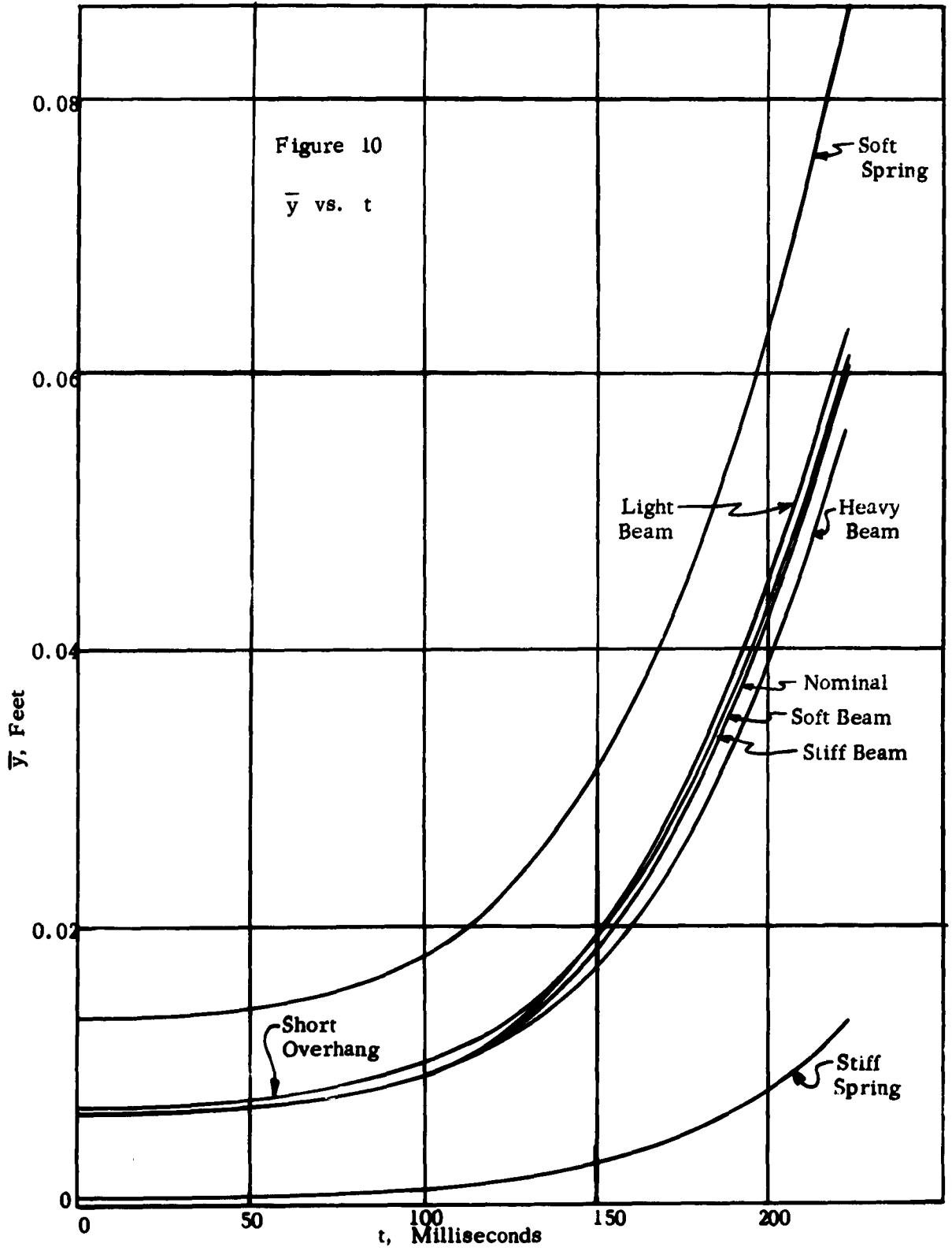

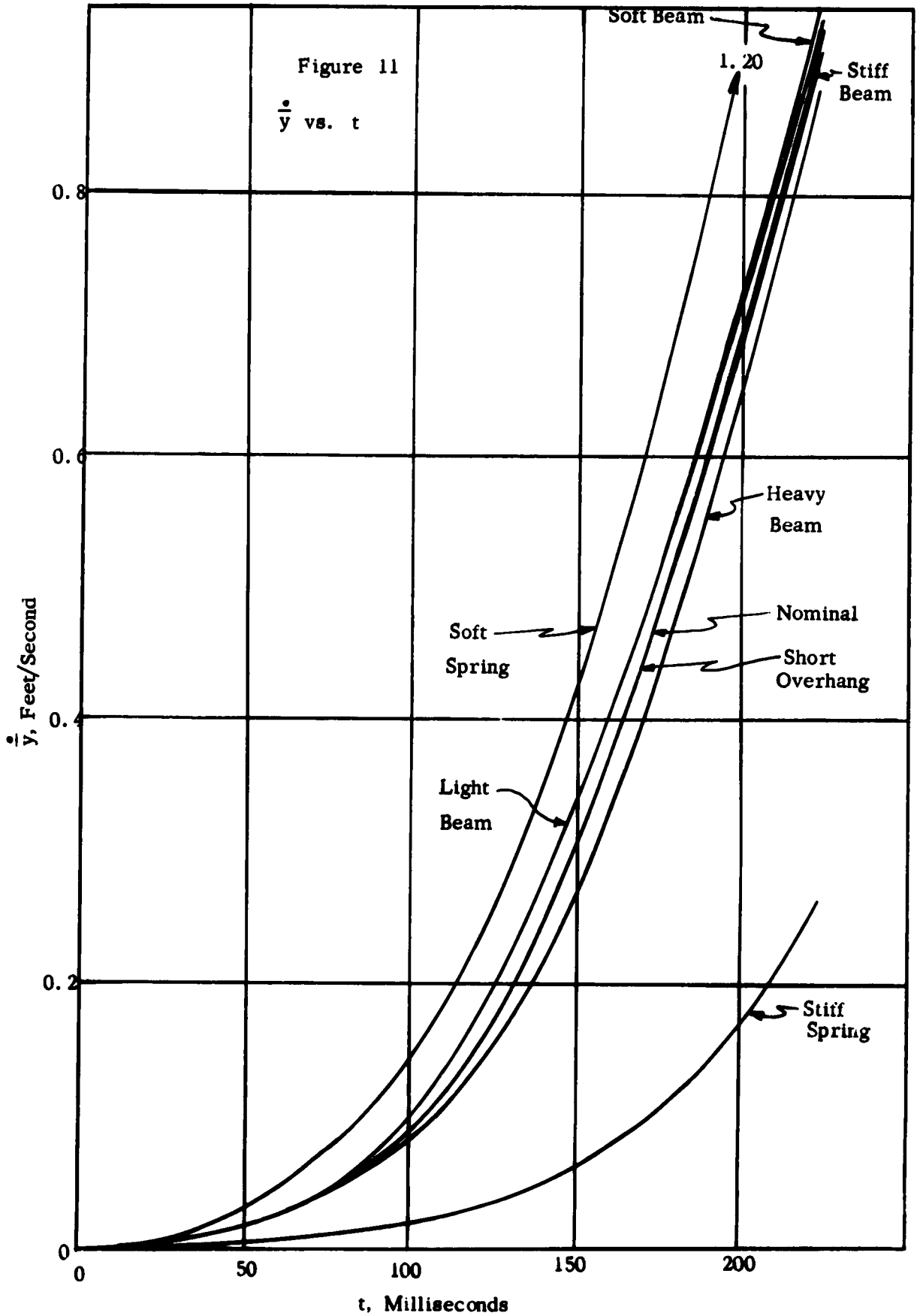

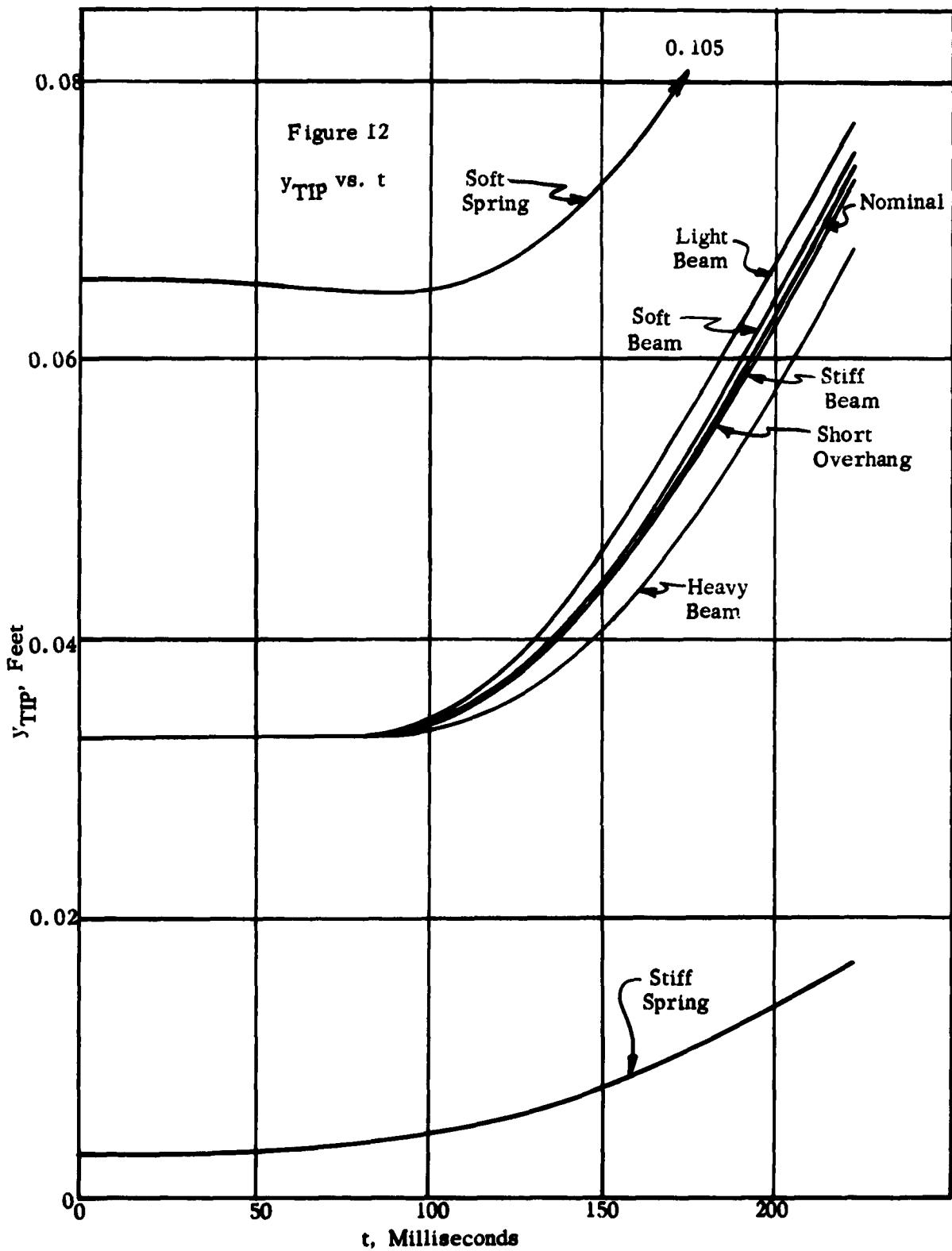

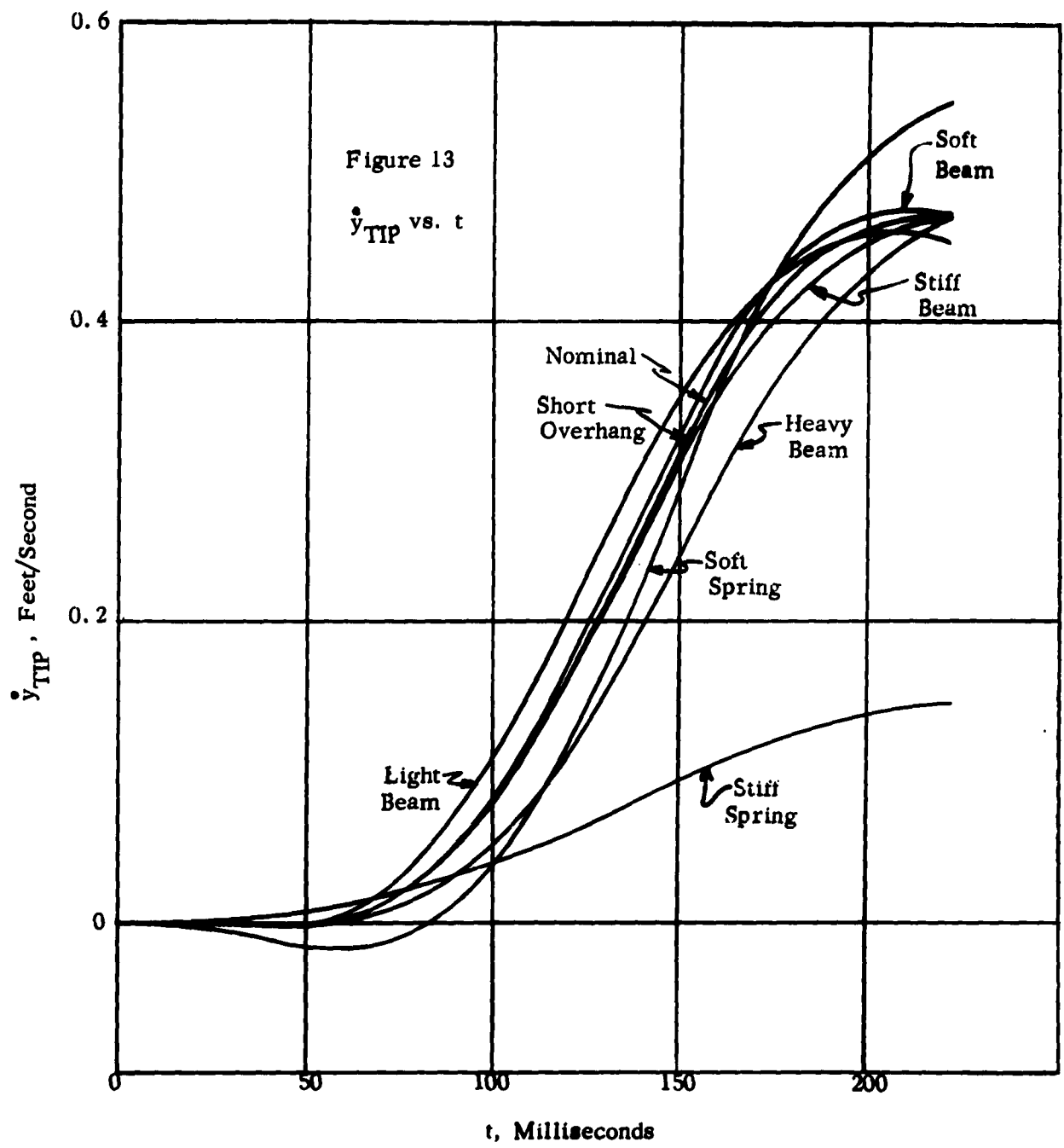

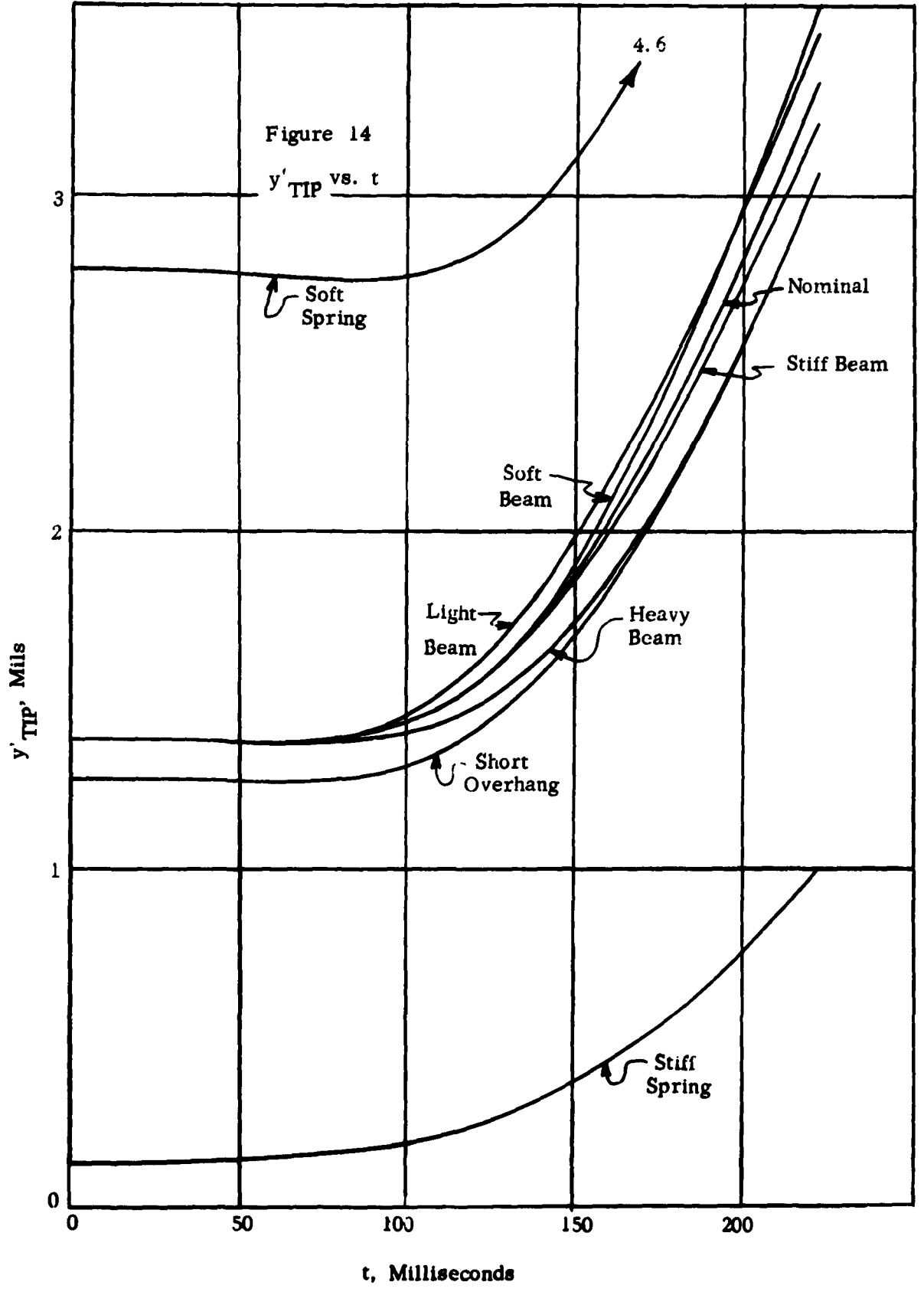

APPENDIX A

Solution for Eq. (5)

Fig. A. 1 shows the beam of Fig. 3 in an unloaded state.

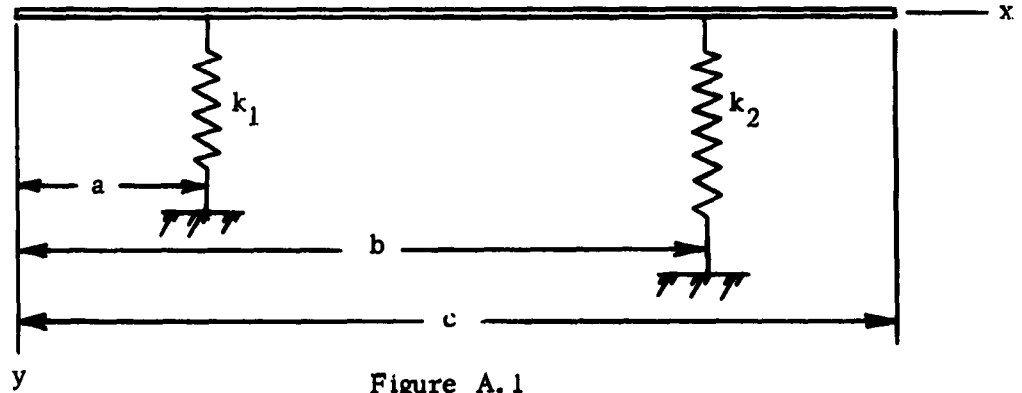

Figure A. 1

The n^{th} normal mode $X_n(x)$ for this spring supported beam are the eigenfunctions of the equation

$$\frac{d^4 X_n}{d x^4} - \lambda_n^4 X_n = 0 \quad (\text{A. 1})$$

whose general solution is

$$X_n(x) = A'_n \sin \lambda_n x + B'_n \cos \lambda_n x + C'_n \sinh \lambda_n x + D'_n \cosh \lambda_n x \quad (\text{A. 2})$$

Since both ends of the beam are free, we must have

$$X''_n(0) = X'''_n(0) = X''_n(c) = X'''_n(c) = 0 \quad (\text{A. 3})$$

At the supports, i. e. at $x = a$ and $x = b$, $X_n(x)$, $X'_n(x)$, and $X''_n(x)$ must be continuous and

$$E I X_n'''(a^-) - E I X_n'''(a^+) - k_1 X_n(a) = 0 \quad (\text{A. 4})$$

$$E I X_n'''(b^-) - E I X_n'''(b^+) - k_2 X_n(b) = 0 \quad (\text{A. 5})$$

In view of Eqs. (A. 4) and (A. 5) we make the following definitions

$$\begin{aligned} 0 \leq x \leq a: X_n(x) = \phi_n(x) = & A_n \sin \lambda_n(a-x) + B_n \cos \lambda_n(a-x) + C_n \sinh \lambda_n(a-x) \\ & + D_n \cosh \lambda_n(a-x) \end{aligned} \quad (\text{A. 6})$$

$$\begin{aligned} a \leq x \leq b: X_n(x) = \mu_n(x) = & E_n \sin \lambda_n x + F_n \cos \lambda_n x + G_n \sinh \lambda_n x \\ & + H_n \cosh \lambda_n x \end{aligned} \quad (\text{A. 7})$$

$$\begin{aligned} b \leq x \leq c: X_n(x) = \eta_n(x) = & I_n \sin \lambda_n(x-b) + J_n \cos \lambda_n(x-b) + K_n \sinh \lambda_n(x-b) \\ & + L_n \cosh \lambda_n(x-b) \end{aligned} \quad (\text{A. 8})$$

Satisfying the conditions on $X_n(x)$ at the supports k_1 and k_2 results in

$$\begin{aligned} A_n &= -E_n \cos \lambda_n a + F_n \sin \lambda_n a + a \Delta_n \mu_n(a) \\ B_n &= E_n \sin \lambda_n a + F_n \cos \lambda_n a \\ C_n &= -G_n \cosh \lambda_n a - H_n \sinh \lambda_n a - a \Delta_n \mu_n(a) \\ D_n &= G_n \sinh \lambda_n a + H_n \cosh \lambda_n a \\ I_n &= E_n \cos \lambda_n b - F_n \sin \lambda_n b - \beta \Delta_n \mu_n(b) \\ J_n &= E_n \sin \lambda_n b + F_n \cos \lambda_n b \\ K_n &= G_n \cosh \lambda_n b + H_n \sinh \lambda_n b - \beta \Delta_n \mu_n(b) \\ L_n &= G_n \sinh \lambda_n b + H_n \cosh \lambda_n b \end{aligned} \quad (\text{A. 9})$$

where

$$a = \frac{1}{2} \frac{k_1}{EI} \quad \beta = \frac{1}{2} \frac{k_2}{EI} \quad \Delta_n = \frac{1}{\lambda_n^3}$$

Using Eqs. (A.9) we now have

$$0 \leq x \leq a: X_n(x) = \phi_n(x) = \mu_n(x) + a \Delta_n \mu_n'(a) \left[\sin \lambda_n(a-x) - \sinh \lambda_n(a-x) \right] \quad (\text{A.10})$$

$$a \leq x \leq b: X_n(x) = \mu_n(x) = E_n \sin \lambda_n x + F_n \cos \lambda_n x + G_n \sinh \lambda_n x + H_n \cosh \lambda_n x \quad (\text{A.11})$$

$$b \leq x \leq c: X_n(x) = \eta_n(x) = \mu_n(x) - \beta \Delta_n \mu_n'(b) \left[\sin \lambda_n(x-b) + \sinh \lambda_n(x-b) \right] \quad (\text{A.12})$$

From the end conditions of Eq. (A.3) we then have

$$\begin{aligned} & E_n a \Delta_n \sin \lambda_n a (\sin \lambda_n a + \sinh \lambda_n a) \\ & + F_n \left[1 + a \Delta_n \cos \lambda_n a (\sin \lambda_n a + \sinh \lambda_n a) \right] \\ & + G_n a \Delta_n \sinh \lambda_n a (\sin \lambda_n a + \sinh \lambda_n a) \\ & + H_n \left[a \Delta_n \cosh \lambda_n a (\sin \lambda_n a + \sinh \lambda_n a) - 1 \right] = 0 \end{aligned}$$

$$\begin{aligned} & E_n \left[a \Delta_n \sin \lambda_n a (\cos \lambda_n a + \cosh \lambda_n a) - 1 \right] \\ & + F_n a \Delta_n \cos \lambda_n a (\cos \lambda_n a + \cosh \lambda_n a) \\ & + G_n \left[1 + a \Delta_n \sinh \lambda_n a (\cos \lambda_n a + \cosh \lambda_n a) \right] \\ & + H_n a \Delta_n \cosh \lambda_n a (\cos \lambda_n a + \cosh \lambda_n a) = 0 \end{aligned}$$

$$\begin{aligned}
& E_n \left\{ -\sin \lambda_n c + \beta \Delta_n \sin \lambda_n b \left[\sin \lambda_n (c-b) - \sinh \lambda_n (c-b) \right] \right\} \\
& + F_n \left\{ -\cos \lambda_n c + \beta \Delta_n \cos \lambda_n b \left[\sin \lambda_n (c-b) - \sinh \lambda_n (c-b) \right] \right\} \\
& + G_n \left\{ \sinh \lambda_n c + \beta \Delta_n \sinh \lambda_n b \left[\sin \lambda_n (c-b) - \sinh \lambda_n (c-b) \right] \right\} \\
& + H_n \left\{ \cosh \lambda_n c + \beta \Delta_n \cosh \lambda_n b \left[\sin \lambda_n (c-b) - \sinh \lambda_n (c-b) \right] \right\} = 0
\end{aligned}$$

$$\begin{aligned}
& E_n \left\{ -\cos \lambda_n c + \beta \Delta_n \sin \lambda_n b \left[\cos \lambda_n (c-b) - \cosh \lambda_n (c-b) \right] \right\} \\
& + F_n \left\{ \sin \lambda_n c + \beta \Delta_n \cos \lambda_n b \left[\cos \lambda_n (c-b) - \cosh \lambda_n (c-b) \right] \right\} \\
& + G_n \left\{ \cosh \lambda_n c + \beta \Delta_n \sinh \lambda_n b \left[\cos \lambda_n (c-b) - \cosh \lambda_n (c-b) \right] \right\} \\
& + H_n \left\{ \sinh \lambda_n c + \beta \Delta_n \cosh \lambda_n b \left[\cos \lambda_n (c-b) - \cosh \lambda_n (c-b) \right] \right\} = 0
\end{aligned}$$

These last four equations are a homogeneous set and for non-zero values of E_n , F_n , G_n , and H_n the determinant of the coefficients must be zero. The roots λ_n of this determinant are the eigenvalues for the problem .

We solve the homogeneous equations in the form

$$E_n = e_n z_n$$

$$F_n = f_n z_n$$

$$G_n = g_n z_n$$

$$H_n = h_n z_n$$

where at least one of the e_n , f_n , g_n , and h_n is one. Then we choose the value of z_n such that

$$\int_0^c X_n(x) X_n(x) dx = \frac{1}{4} \left[x X_n^2 + \frac{3}{\lambda_n^4} X_n X_n''' - \frac{X_n' X_n''}{\lambda_n^4} + \frac{x}{\lambda_n^4} (X_n'')^2 - \frac{2x}{\lambda_n^4} X_n' X_n''' \right]_0^c = 1$$

For this problem this means that z_n is chosen such that

$$\frac{1}{4} \left\{ 6a \Delta_n [\eta_n(a)]^2 - 4a a \eta_n'(a) \eta_n(a) + 6\beta \Delta_n [\eta_n(b)]^2 - 4\beta b \mu_n'(b) \mu_n(b) + c [\eta_n(c)]^2 \right\} = 1$$

To prove that

$$\int_0^c X_m(x) X_n(x) dx = 0 \quad \text{for} \quad m \neq n$$

we write

$$X_m X_n^{IV} - \lambda_n^4 X_m X_n = 0$$

$$X_n X_m^{IV} - \lambda_m^4 X_m X_n = 0$$

Subtracting and integrating over the length of the beam results in

$$(\lambda_n^4 - \lambda_m^4) \int_0^c X_m(x) X_n(x) dx = \int_0^c (X_m X_n^{IV} - X_n X_m^{IV}) dx$$

Integrating the right hand side by parts yields

$$\begin{aligned} (\lambda_n^4 - \lambda_m^4) \int_0^c X_m(x) X_n(x) dx = & \left[\phi_m \phi_n''' - \phi_m' \phi_n'' \right]_0^a + \left[\mu_m \mu_n''' - \mu_m' \mu_n'' \right]_a^b \\ & + \left[\eta_m \eta_n''' - \eta_m' \eta_n'' \right]_b^c - \left[\phi_n \phi_m''' - \phi_n' \phi_m'' \right]_0^a \\ & - \left[\mu_n \mu_m''' - \mu_n' \mu_m'' \right]_a^b - \left[\eta_n \eta_m''' - \eta_n' \eta_m'' \right]_b^c \end{aligned}$$

And upon applying the conditions on $\phi_n(x)$, $\mu_n(x)$, and $\eta_n(x)$ we have

$$(\lambda_n^4 - \lambda_m^4) \int_0^c X_m(x) X_n(x) dx = 0$$

Since in general $\lambda_n^4 - \lambda_m^4 \neq 0$ then

$$\int_0^c X_n(x) X_m(x) dx = 0 \quad \text{for } m \neq n$$

Thus proving the orthogonality of the beam functions $\{X_n(x)\}$.

For Eq. (10) we write

$$\lambda_n^4 q_n(0) = \int_0^c X_n^{IV}(x) y(x, 0) dx$$

Integrating by parts results in

$$\lambda_n^4 q_n(0) = \left[X_n'''(x) y(x, 0) - X_n''(x) y'(x, 0) + X_n'(x) y''(x, 0) - X_n(x) y'''(x, 0) \right]_0^c + \int_0^c X_n(x) y^{IV}(x, 0) dx.$$

For a beam statically loaded with concentrated loads $y^{IV}(x, 0)$ is zero and for the beam of Fig. A. 1 $y(x, 0)$, $y'(x, 0)$, and $y''(x, 0)$ must be continuous and $y'''(x, 0)$ satisfies the same discontinuity conditions which $X_n(x)$ satisfies.

Therefore the final results for $q_n(0)$ can be shown to be

$$q_n(0) = \frac{m \bar{g}}{\rho A \omega_n^2} \left[h X_n(\xi_0) + d X_n(\xi_0 + L) \right] \quad (\text{A. 13})$$

**DISTRIBUTION LIST
FOR TECHNICAL REPORTS UNDER
LAUNCHER DYNAMICS CONTRACT**

Office, Chief of Ordnance Department of the Army Washington 25, D. C. ATTN: ORDTW ORDTB ORDTU	1 1 1	Commanding General Aberdeen Proving Ground Aberdeen, Md. ATTN: ORDBG-BRL	1
Commanding General Ordnance Weapons Command Rock Island, Illinois ATTN: ORDOW-TL	2	Commander Armed Services Technical Information Agency Document Service Center Arlington Hall Station Arlington 12, Va. ATTN: DSC-SE	10
Commander Army Ballistics Missile Agency Redstone Arsenal, Ala. ATTN: ORDAB-RAP ORDAB-RH	2 1	Commanding Officer Diamond Ordnance Fuze Laboratory Connecticut Ave. & Van Ness Washington 25, D. C. ATTN: Technical Reference Section	1
Commanding General Headquarters, CONARC Fort Monroe, Va. ATTN: Chief Development Section	1	Commanding Officer Rock Island Arsenal Rock Island, Ill. ATTN: 9310 5100	17 1
Commandant U. S. Army, A & M School Fort Sill, Okla.	1	Commanding Officer Picatinny Arsenal Dover, N. J.	1
President U. S. Army Artillery Board Fort Sill, Okla.	1	Director Marine Corps Development Center Marine Corps Schools Quantico, Va.	1
Department of Ordnance U. S. Military Academy West Point, N. Y.	1	Commanding General U. S. Army Ordnance Test Activity Yuma Test Station Yuma, Arizona	1
Commanding General Army Rocket & Guided Missile Agency Redstone Arsenal, Ala.	1	Commanding General White Sands Missile Range Las Cruces, N. M.	1
Commanding Officer Chicago Ordnance District 623 S. Wabash Ave. Chicago 6, Ill.	2		

AD _____ Div. 22

University of Illinois, Dept. of TAM, Urbana, Illinois
ANALYSIS OF MISSILE LAUNCHERS, PART M₁
TWO POINT MASS MOVING ON A FLEXIBLE BEAM
by C. C. Fretwell, March, 1962, 37 pages incl. illus.
Contract DA-11-070-508-ORD-593, Proj. No. 517-01-002

Contains an approximate analysis of the motion of a flexible launcher rail which is supported by a flexible understructure and is loaded by a missile with two point contact which moves across the rail under the action of a prescribed thrust force. A pair of coupled integral equations are obtained which define the motion of the missile and a numerical technique of integration is developed for their solution. Numerical results are presented.

AD _____ Div. 22

University of Illinois, Dept. of TAM, Urbana, Illinois
ANALYSIS OF MISSILE LAUNCHERS, PART M₁
TWO POINT MASS MOVING ON A FLEXIBLE BEAM
by C. C. Fretwell, March, 1962, 37 pages incl. illus.
Contract DA-11-070-508-ORD-593, Proj. No. 517-01-002

Contains an approximate analysis of the motion of a flexible launcher rail which is supported by a flexible understructure and is loaded by a missile with two point contact which moves across the rail under the action of a prescribed thrust force. A pair of coupled integral equations are obtained which define the motion of the missile and a numerical technique of integration is developed for their solution. Numerical results are presented.

AD _____ Div. 22

University of Illinois, Dept. of TAM, Urbana, Illinois
ANALYSIS OF MISSILE LAUNCHERS, PART M₁
TWO POINT MASS MOVING ON A FLEXIBLE BEAM
by C. C. Fretwell, March, 1962, 37 pages, incl. illus.
Contract DA-11-070-508-ORD-593, Proj. No. 517-01-002

Contains an approximate analysis of the motion of a flexible launcher rail which is supported by a flexible understructure and is loaded by a missile with two point contact which moves across the rail under the action of a prescribed thrust force. A pair of coupled integral equations are obtained which define the motion of the missile and a numerical technique of integration is developed for their solution. Numerical results are presented.

AD _____ Div. 22

University of Illinois, Dept. of TAM, Urbana, Illinois
ANALYSIS OF MISSILE LAUNCHERS, PART M₁
TWO POINT MASS MOVING ON A FLEXIBLE BEAM
by C. C. Fretwell, March, 1962, 37 pages, incl. illus.
Contract DA-11-070-508-ORD-593, Proj. No. 517-01-002

Contains an approximate analysis of the motion of a flexible launcher rail which is supported by a flexible understructure and is loaded by a missile with two point contact which moves across the rail under the action of a prescribed thrust force. A pair of coupled integral equations are obtained which define the motion of the missile and a numerical technique of integration is developed for their solution. Numerical results are presented.

AD

Div. 22

University of Illinois, Dept. of TAM, Urbana, Illinois
ANALYSIS OF MISSILE LAUNCHERS, PART M₁
TWO POINT MASS MOVING ON A FLEXIBLE BEAM
by C. C. Fretwell, March, 1962, 37 pages incl. illus.
Contract DA-11-070-508-ORD-593, Proj. No. 517-01-002

Contains an approximate analysis of the motion of a flexible launcher rail which is supported by a flexible understructure and is loaded by a missile with two point contact which moves across the rail under the action of a prescribed thrust force. A pair of coupled integral equations are obtained which define the motion of the missile and a numerical technique of integration is developed for their solution. Numerical results are presented.

AD

Div. 22

University of Illinois, Dept. of TAM, Urbana, Illinois
ANALYSIS OF MISSILE LAUNCHERS, PART M₁
TWO POINT MASS MOVING ON A FLEXIBLE BEAM
by C. C. Fretwell, March, 1962, 37 pages incl. illus.
Contract DA-11-070-508-ORD-593, Proj. No. 517-01-002

Contains an approximate analysis of the motion of a flexible launcher rail which is supported by a flexible understructure and is loaded by a missile with two point contact which moves across the rail under the action of a prescribed thrust force. A pair of coupled integral equations are obtained which define the motion of the missile and a numerical technique of integration is developed for their solution. Numerical results are presented.

AD

Div. 22

University of Illinois, Dept. of TAM, Urbana, Illinois
ANALYSIS OF MISSILE LAUNCHERS, PART M₁
TWO POINT MASS MOVING ON A FLEXIBLE BEAM
by C. C. Fretwell, March, 1962, 37 pages, incl. illus.
Contract DA-11-070-508-ORD-593, Proj. No. 517-01-002

Contains an approximate analysis of the motion of a flexible launcher rail which is supported by a flexible understructure and is loaded by a missile with two point contact which moves across the rail under the action of a prescribed thrust force. A pair of coupled integral equations are obtained which define the motion of the missile and a numerical technique of integration is developed for their solution. Numerical results are presented.

AD

Div. 22

University of Illinois, Dept. of TAM, Urbana, Illinois
ANALYSIS OF MISSILE LAUNCHERS, PART M₁
TWO POINT MASS MOVING ON A FLEXIBLE BEAM
by C. C. Fretwell, March, 1962, 37 pages, incl. illus.
Contract DA-11-070-508-ORD-593, Proj. No. 517-01-002

Contains an approximate analysis of the motion of a flexible launcher rail which is supported by a flexible understructure and is loaded by a missile with two point contact which moves across the rail under the action of a prescribed thrust force. A pair of coupled integral equations are obtained which define the motion of the missile and a numerical technique of integration is developed for their solution. Numerical results are presented.