

**2012 NDIA GROUND VEHICLE SYSTEMS ENGINEERING AND TECHNOLOGY
SYMPOSIUM
POWER AND MOBILITY (P&M) MINI-SYMPOSIUM
AUGUST 14-16, MICHIGAN**

**MODERNIZING THE OPPOSED-PISTON ENGINE FOR MORE
EFFICIENT MILITARY GROUND VEHICLE APPLICATIONS**

**Laurence Fromm
Dr. Randy Herold
John Koszewnik
Dr. Gerhard Regner**
Achates Power, Inc.
San Diego, CA

ABSTRACT

This paper provides a brief historical look at opposed-piston, two-stroke (OP2S) engines and their use in military applications. It also highlights the engine's fundamental architectural advantages. In addition, the paper introduces the Achates Power opposed-piston engine, providing detailed, measured results of its power density, thermal efficiency and low heat rejection. Furthermore, the paper includes an overview of the fundamental challenges of OP2S engines, along with a discussion of how Achates Power has addressed these issues. Finally, the paper demonstrates that the operating characteristics of the Achates Power opposed-piston engine allow for optimizing the power density of the entire vehicle propulsion system as defined by Charles Raffa, Ernest Schwarz and John Tasdemir [1].

INTRODUCTION

Opposed-piston engines have a long history, starting with the Junkers Jumo 205 diesel aviation engine from the 1930s and continuing today in marine diesel engines. Each cylinder has two facing pistons that come together at top dead center and move outward upon combustion. Since the pistons cyclically expose or occlude the exhaust and intake ports, there is no valve train, camshaft, pushrods, rocker arms, valves, valve springs, valve keepers, etc. Because the intake and exhaust ports are at the opposite ends of the cylinder, opposed-piston engines have efficient, uniflow scavenging.

Opposed-piston engines, when properly sized and configured, have inherent thermodynamic advantages [2]. Due to the high thermal efficiency and lack of cylinder heads, OP engines have lower heat rejection to coolant. Moreover, as a two-stroke engine, they have inherently high specific power. By eliminating cylinder heads and the valve train, OP engines cost less than conventional four-stroke engines.

Achates Power was formed in 2004 to modernize the opposed-piston engine, and has achieved breakthroughs in combustion efficiency and thermal efficiency, demonstrated through more than 3,000 hours of dynamometer testing. While much of the development by Achates Power is directed at

commercial and passenger vehicle markets, high thermal efficiency, high specific power and low heat rejection make the Achates Power opposed-piston engine ideally suited for military applications as well.

DESIGN ATTRIBUTES

Several design attributes of the Achates Power opposed-piston, two-stroke engine optimize its performance.

Opposed-Piston Architecture

The advantages of opposed-piston engines are described in the book, *Opposed Piston Engines: Evolution, Use, and Future Applications* [3]:

“OP engines evolved because of their ease of manufacture, excellent balance, and competitive performance and fuel-efficiency relative to comparable four-stroke engines....With the progressive development of OP engines...other significant advantages also emerged...Among these advantages were cutting-edge specific output, high specific torque, very high power density, and very high power-to-bulk ratio....Other OP two-stroke advantages, compared to the four-stroke engine, were relatively low heat-to-coolant ratios, high reliability and low maintenance, relative ease of servicing, excellent multi-

Report Documentation Page

Form Approved
OMB No. 0704-0188

Public reporting burden for the collection of information is estimated to average 1 hour per response, including the time for reviewing instructions, searching existing data sources, gathering and maintaining the data needed, and completing and reviewing the collection of information. Send comments regarding this burden estimate or any other aspect of this collection of information, including suggestions for reducing this burden, to Washington Headquarters Services, Directorate for Information Operations and Reports, 1215 Jefferson Davis Highway, Suite 1204, Arlington VA 22202-4302. Respondents should be aware that notwithstanding any other provision of law, no person shall be subject to a penalty for failing to comply with a collection of information if it does not display a currently valid OMB control number.

1. REPORT DATE 20 AUG 2012		2. REPORT TYPE Journal Article		3. DATES COVERED 20-07-2012 to 19-08-2012	
4. TITLE AND SUBTITLE MODERNIZING THE OPPOSED-PISTON ENGINE FOR MORE EFFICIENT MILITARY GROUND VEHICLE APPLICATIONS				5a. CONTRACT NUMBER	
				5b. GRANT NUMBER	
				5c. PROGRAM ELEMENT NUMBER	
6. AUTHOR(S) Laurence Fromm; Randy Herold; John Koszewnik; Gerhard Regner				5d. PROJECT NUMBER	
				5e. TASK NUMBER	
				5f. WORK UNIT NUMBER	
7. PERFORMING ORGANIZATION NAME(S) AND ADDRESS(ES) Achates Power, Inc.,4060 Sorrento Valley Boulevard,San Diego,CA,92121				8. PERFORMING ORGANIZATION REPORT NUMBER ; #23224	
9. SPONSORING/MONITORING AGENCY NAME(S) AND ADDRESS(ES) U.S. Army TARDEC, 6501 East Eleven Mile Rd, Warren, Mi, 48397-5000				10. SPONSOR/MONITOR'S ACRONYM(S) TARDEC	
				11. SPONSOR/MONITOR'S REPORT NUMBER(S) #23224	
12. DISTRIBUTION/AVAILABILITY STATEMENT Approved for public release; distribution unlimited					
13. SUPPLEMENTARY NOTES Submitted to 2012 NDIA GROUND VEHICLE SYSTEMS ENGINEERING AND TECHNOLOGY SYMPOSIUM August 14-16, Michigan					
14. ABSTRACT This paper provides a brief historical look at opposed-piston, two-stroke (OP2S) engines and their use in military applications. It also highlights the engine's fundamental architectural advantages. In addition, the paper introduces the Achates Power opposed-piston engine, providing detailed, measured results of its power density, thermal efficiency and low heat rejection. Furthermore, the paper includes an overview of the fundamental challenges of OP2S engines, along with a discussion of how Achates Power has addressed these issues. Finally, the paper demonstrates that the operating characteristics of the Achates Power opposed-piston engine allow for optimizing the power density of the entire vehicle propulsion system as defined by Charles Raffa, Ernest Schwarz and John Tasdemir [1].					
15. SUBJECT TERMS					
16. SECURITY CLASSIFICATION OF:			17. LIMITATION OF ABSTRACT Public Release	18. NUMBER OF PAGES 9	19a. NAME OF RESPONSIBLE PERSON
a. REPORT unclassified	b. ABSTRACT unclassified	c. THIS PAGE unclassified			

fuel tolerance, low injection pressures, and simple fuel injection nozzles.”

The source and magnitude of the thermal efficiency advantage has been described by Achates Power [2]. Eliminating the cylinder heads has two advantages. The surface area/volume ratio is reduced compared to conventional engines, decreasing heat transfer, which increases indicated thermal efficiency. And since cylinder heads are cooled to lower maximum temperatures than pistons, the heat transfer benefits of the opposed-piston design are even greater. Also, the stroke is split between two pistons, enabling high stroke/bore ratios without excessive mean piston speeds. Since intake and exhaust ports are on opposite sides of the cylinder, efficient uniflow scavenging is utilized.

Two-Stroke Operation

Two-stroke engines have fuel efficiency advantages compared to four-stroke engines [2]. The amount of fuel injected for each combustion event can be reduced to roughly half for the same power as a four-stroke engine. This provides two thermal efficiency advantages to the two-stroke engine:

- A leaner operating condition at the same boost pressure maintains a higher ratio of specific heats during combustion.
- A reduced energy release density at the same power level allows for a shorter combustion duration without exceeding a maximum rate of pressure rise constraints.

Moreover, as a two-stroke, the Achates Power engine allows for optimized pumping losses by only partially scavenging the exhaust from the combustion chamber. This is accomplished by controlling the supercharger, a feature that avoids the complex and expensive design of the variable valve train mechanisms used for the same purpose in four-stroke engines.

The double firing frequency also provides specific power advantages. Since each cylinder fires every revolution in a two-stroke engine, engine displacement can be reduced for the same power as a four-stroke engine without exceeding peak cylinder pressures or other design constraints.

Power Cylinder System

The heart of the engine is the power cylinder system. It includes the pistons, cylinders, cylinder liners, port designs and fuel system design, and has been designed, manufactured, tested and refined through iterative versions on a series of single-cylinder test engines to prove the performance and emissions capability and durability of the engine.

Using computational fluid dynamic studies correlated with single-cylinder engine test results, a very clean and efficient combustion system for opposed-piston engines has been developed. Of critical importance, the design results in large stoichiometric isosurfaces with excellent mixing and charge motion at the point of auto-ignition. These combustion system attributes are accomplished with a unique set of intake ports that provide swirl, coupled with mating converging-crown pistons that induce tumble. Additionally, a unique and proprietary nozzle design provides interdigitated fuel plumes with the appropriate flow rates and penetration. Together, this hardware combination provides for very fast burn rates, contributing to both power and fuel efficiency.

Lastly, port timing has been optimized over multiple CFD and physical testing iterations of the cylinder liner to provide the optimal blow-down, uniflow scavenging and supercharging characteristics. An example of CFD simulation results is shown in Figure 1. In the first frame, in the upper left, the expansion cycle after combustion is well underway. In the next frame, to the right, the exhaust (left side) ports open as the pistons continue their outward travel, and blowdown begins. During blowdown, the intake is closed so only exhaust gas leaves the cylinder via the exhaust ports. The intake ports in this example open at a 145° crank angle. The pressure in the cylinder falls below the pressure level of the intake manifold and fresh charge starts to enter the cylinder. This is the start of the scavenging phase where intake and exhaust ports are open at the same time. Scavenging continues until a 230° crank angle, at which time the exhaust ports close. The final frame in the diagram shows a small amount of residual gas left in the cylinder. Careful design and analysis of the ports, manifolds and gas exchange system balances good scavenging efficiency while minimizing pumping losses.

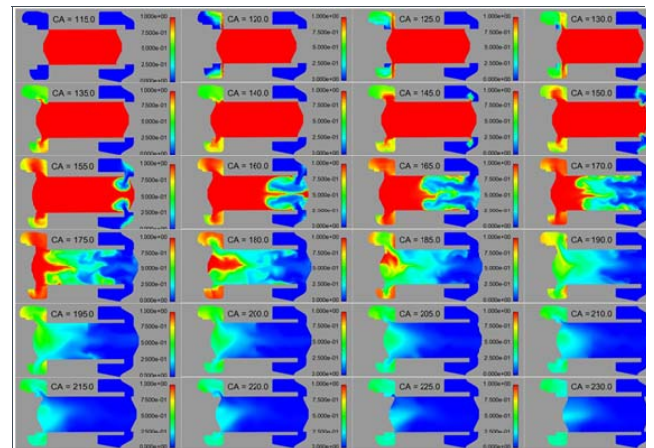

Figure 1: Full Load CFD Simulation Results of In-cylinder Gas Exchange

In addition to serving as the foundation for all combustion development, the single-cylinder was also used to validate the durability of the power cylinder components. This includes successful completion of a 50-hour AEP-5 NATO durability test, which further demonstrates the mechanical integrity of the power cylinder system.

Cranktrain System

Several mechanical design arrangements of crankshafts and connecting rods to articulate the pistons have been analyzed, developed and tested. The dual-crankshaft, Jumo-style arrangement has several advantages. A cut-away of this arrangement and a 3-cylinder representation is shown in Figure 2. This mechanical design is referred to by Achates Power as the “A48” design, and its advantages include robustness, compactness and low friction.

Most of the successful opposed-piston engines throughout history utilize the dual-crankshaft architecture that is similar to the A48, including Junkers Jumo 205 and 207, Fairbanks Morse 38D, Rolls Royce K60, Leyland L60, Kharkiv Morozov and Coventry Climax H30. A number of improvements have been made to the architecture to address concerns about piston thermal management, cylinder thermal management, wrist pin durability and piston ring durability. These improvements have been tested and are discussed in more detail in the section on Risk Elements and Mitigation.

The virtues of the Achates Power A48 engine architecture include:

- **Conventional crank-slider mechanism**
The A48 architecture uses conventionally designed crankshafts and connecting rods, which are commonplace in the industry. It does not require any unconventional and unproven engine mechanisms.
- **Integrated internal gear train**
The A48 mechanism has an internal gear train, which allows the flexibility to have the power taken off of any crankshaft or idler gear. A depiction of a generic geartrain is shown in Figure 2. The engine characteristics as seen by the transmission input can be varied, then, by altering the gear ratios of the internal gear train if power is taken off one of the idler gears. If an application requires high torque, a drive ratio can be chosen to reduce speed of the engine output shaft. Other applications might benefit from increased output speed at reduced torque to drive, for example, a high-speed generator in hybrid drive applications. The engine, then, can serve a wide range of applications from a core

engine design by altering the gear ratio of the internal gear train.

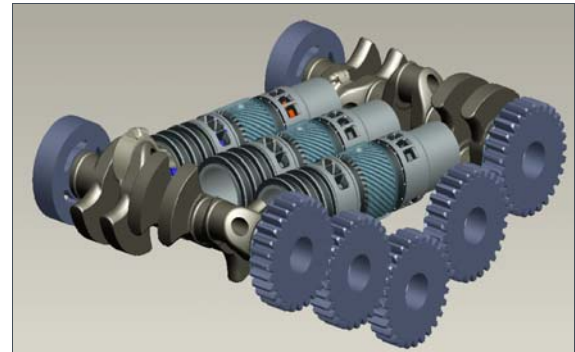

Figure 2: Cutaway of Power Module Concept, Showing Internal Gear Train

- **Compact shape**
Compared to other opposed-piston architectures, the A48 design does not suffer from excessive width or volume, yet still maintains a thermally-efficient stroke/bore ratio. Indeed, the compact flat shape of the A48 architecture (similar to the familiar boxer-style engine) lends itself to enhanced packaging options. Moreover, because of the compact size of the architecture, A48 variants have been designed that package into existing passenger and commercial vehicles.

Optimal Stroke-to-Bore Ratio

Extensive analysis has been performed to determine the optimal stroke/bore ratio needed to maximize engine thermal efficiency. There are three main effects to consider:

- In-cylinder heat transfer decreases as the stroke/bore ratio increases due to a decreased combustion chamber area/volume ratio. The decreased heat transfer directly leads to higher indicated thermal efficiency and reduced heat rejection to the coolant. Figure 3 shows simulated indicated thermal efficiency loss calculated at the same operating conditions for a range of cylinder stroke/bore ratios. The effect is non-linear as the change in indicated thermal efficiency gets progressively worse as the stroke/bore ratio decreases.



Figure 3: Effect of Stroke/Bore Ratio on Indicated Thermal Efficiency

- The scavenging efficiency increases as the stroke/bore ratio is increased. To quantify the impact this effect has on engine efficiency, Achates Power combined 3D CFD and 1D simulations to calculate the change in pumping work (measured as a percent of fuel energy) required to maintain a constant scavenging efficiency with changes in the stroke/bore ratio. Results of these simulations are provided in Figure 4, which shows the change in pumping work relative to that obtained with a stroke/bore ratio of 2.65. The pumping work increases rapidly after the stroke/bore ratio decreases below 2.2.

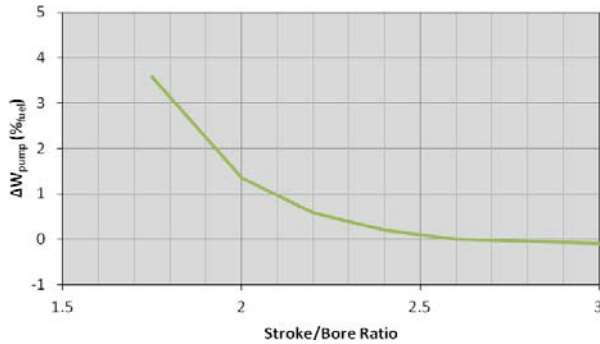

Figure 4: Effect of Stroke/Bore Ratio on Pumping Work

- Engine friction was found to have a non-linear dependence on stroke/bore ratio, as displayed in Figure 5. Using a published friction model [4], Achates Power found that the crankshaft bearing friction decreases as the stroke/bore ratio increases, while the power-cylinder friction has the opposite effect. The net effect is that the friction increases when the stroke/bore ratio exceeds a value of about

2.3, although the magnitude of the effect is much smaller than the heat transfer and pumping effects.

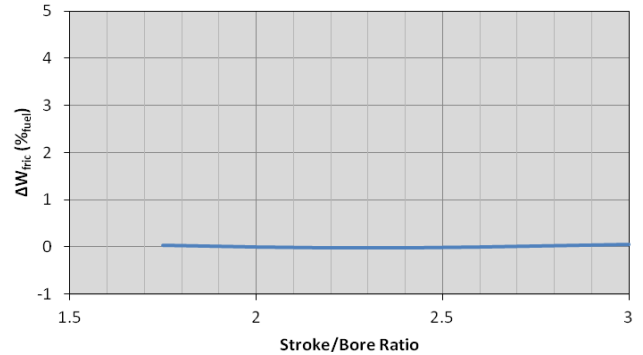

Figure 5: Effect of Stroke/Bore Ratio on Friction Work

Combining these factors, indicated thermal efficiency and pumping work benefit from a longer stroke/bore ratio. Friction work decreases until a stroke/bore value of about 2.3 and then increases as the stroke/bore is increased further. Any opposed-piston engine with a stroke/bore below 2.0 will be compromised from an efficiency and heat rejection-to-coolant basis.

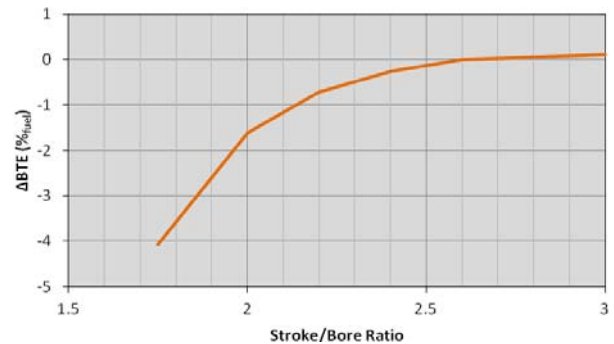

Figure 6: Combined Impact of Stroke/Bore Ratio on BTE

Three-Cylinder Configuration

Extensive analysis has determined that a 3-cylinder, opposed-piston engine is optimal from a gas exchange perspective compared to 2-cylinder or 4-cylinder versions, primarily due to gas dynamical effects. As shown in Figure 7, the gas exchange duration in a two-stroke engine is about 120° crank angle. In a three-cylinder design, the scavenging events are aligned in a way that they have minimal interference with each other and still keep enough mass flow going over the cycle to provide

adequate energy to the turbocharger so it operates most efficiently to compress the intake air.

In a two-cylinder configuration, however, the gas-exchange events are too far separated in time. This separation causes the turbocharger to lose energy over the cycle, which has a negative effect on the turbine's efficiency—especially at lower loads and engine speeds. The loss on turbocharger energy has to be compensated by the crank-driven supercharger, which causes a reduction in brake thermal efficiency.

Conversely, in a four-cylinder configuration, the gas-exchange events overlap too much. This causes the cross charging to occur at a point in time when hot exhaust gases are leaving the cylinder. The interruption of exhaust gas flow causes an increase in residual gas content and, therefore, a lower scavenging efficiency—leading to a reduction in power. Even with a complex design of the exhaust manifold to separate the pulses, there will be communication over the twin scroll turbine housing. Separating the exhaust system into two turbochargers leads back to the two-cylinder problem with the energy flow leak over the cycle.

Two-, 4-, and 5- cylinder options are all viable as part of a family of engines—and indeed speak to the modularity of the design—but a 3-cylinder design is optimal.

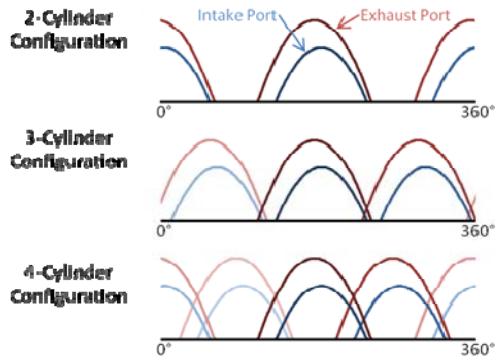

Figure 7: Cross-charging in a 2-stroke Engine

Air-Handling System

Both a current production supercharger and fixed geometry turbocharger are used. The turbocharger utilizes exhaust energy to compress air downstream of the compressor wheel. The supercharger is required to provide the initial boost used for starting, and the supercharger and its associated recirculation valve are used to adjust boost pressure into the intake manifold to manage the gas exchange process while minimizing pumping losses. The supercharger drive system is

optimized to maintain high thermal efficiency over the entire engine map, increase low-speed torque, and enhance the cold-start capability of the engine. In addition, the supercharger improves transient performance and acts as an EGR pump for efficient exhaust gas recirculation.

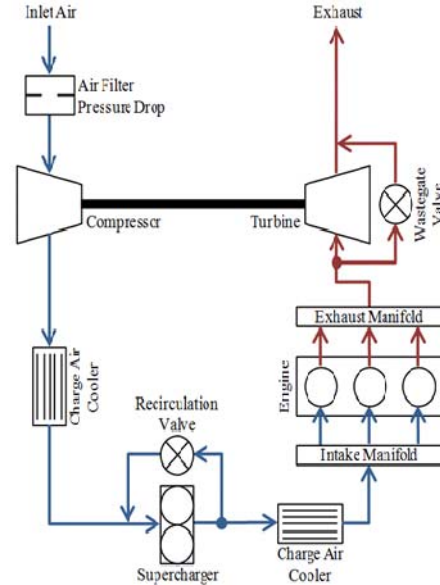

Figure 8: Air Handling System Layout

Fuel Injection

The engine has a 2000 bar capable, common-rail, fuel-injection system using production Bosch injectors. Unique nozzles were created to account for the different combustion chamber geometry inherent in the opposed-piston engine. Each cylinder contains two injectors facing each other. This proprietary design has been extensively tested.

Cooling System

The consequence of high specific power is higher thermal loading into the engine components, especially the pistons. In order to cope with the heat going into the pistons, a conventional gallery-cooled design is used, with dual oil cooling jets per piston providing the necessary oil flow to maintain acceptable piston temperatures. The gallery cooling has been developed and tested on the single-cylinder research engine.

The cylinder liner contains a water jacket to reject the combustion heat out of the liner. A patented cylinder liner design has been developed in order to manage the high thermal loading at the center of the liner and at the exhaust port

bridges. The cooling arrangement for the liner has been developed and tested on the single-cylinder research engine.

Summary of Architectural and Design Advantages

The Achatas Power opposed-piston engine has been designed to meet emissions and durability requirements while minimizing fuel consumption. The following architectural and design advantages combine to make it the superior solution.

Feature	Optimal	Achatas Engine	Rationale
Cycle	2-Stroke	2-Stroke	<ul style="list-style-type: none"> Combustion event in every cylinder every revolution ¹ High indicated thermal efficiency from leaner combustion ^{2,3} Low pumping loss by only partially scavenging cylinder at times ^{2,3}
Architecture	Opposed Piston	Opposed Piston	<ul style="list-style-type: none"> Favorable surface area to volume increases indicated thermal efficiency and reduces heat rejection to coolant ^{2,3}
Stroke/Bore	>2.4	2.65	<ul style="list-style-type: none"> Improved scavenging reduces pumping loss ^{2,3} Reduced heat transfer increases indicated thermal efficiency and reduces heat rejection to coolant ^{2,3}
Cylinder Count	3	3	<ul style="list-style-type: none"> 3-cylinder design maintains turbocharger energy while eliminating negative cross-charging effects ^{1,2,3}
Combustion System	Efficiency optimized	Efficiency optimized	<ul style="list-style-type: none"> The patented Achatas Power combustion system, including injector design and configuration, piston bowl design, and port design, is proven to have extremely high indicated thermal efficiency and low pumping losses ^{2,3}

Note: 1 = High Power Density; 2 = Low Fuel Consumption; 3 = Low Heat Rejection

Table 1: Design Advantages of Achatas Power Engine

The Achatas Power engine has been configured to optimize fuel consumption and heat rejection characteristics. Given large vehicle space requirements for fuel systems and cooling systems, the approach of minimizing the fuel consumption and heat rejection reduces the overall power pack power density. Additionally, by reducing the heat rejected to coolant, the frontal area of the radiator can be decreased, offering aerodynamic efficiency advantages.

MEASURED PERFORMANCE
Performance and Emissions

Based on measurements from the single-cylinder test engine, a fully configured¹ 3.2L three-cylinder Achatas engine is expected to consume, at its most efficient point, 185 g/kWh of fuel. The peak power of the engine is 225 hp. The projected fuel map for the multi-cylinder engine is shown below.

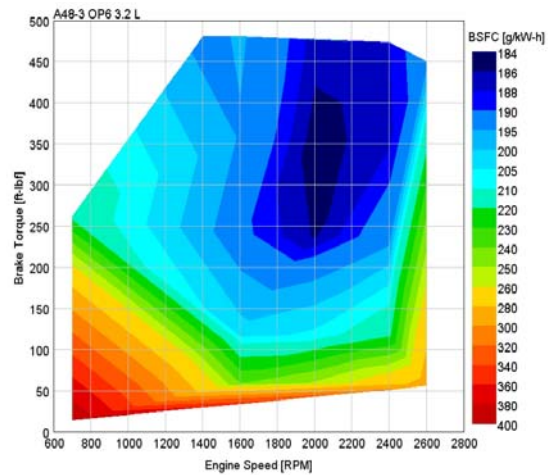

Figure 9: Predicted BSFC Map For 3.2L Engine

Larger and smaller engines can be designed, and will exhibit similar thermal efficiency and heat rejection advantages.

Heat Rejection

Based on measured results and a GT-Power model, the engine is expected to reject 59% of brake power as heat to coolant at its maximum power. The heat rejection is split into two parts: heat rejected by the high temperature radiator used to extract combustion heat from the cylinder and from the engine oil cooler, and heat rejected by the low temperature radiator used to capture heat from the air handling and EGR system upstream and downstream of the supercharger.

¹ Includes coolant and oil pumps, fuel injection system, air system (turbocharger and supercharger), alternator (unloaded), air condition compressor (unloaded), air compressor (unloaded), and power steering pump (unloaded)

The coolant outlet temperature from the high temperature radiator usually is in the range of 85°C to 95°C, while the coolant temperature in the low temperature radiator was set to 36°C. The plot below shows the engine energy balance at C75 in form of a pie chart for brake power, overall heat rejection in high and low temperature radiator, and exhaust enthalpy.

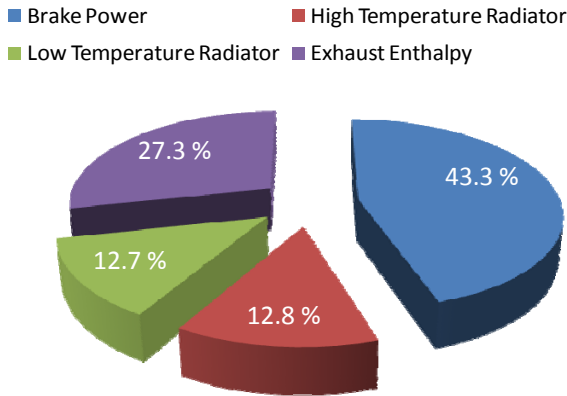

Figure 10: Predicted Energy Balance at Peak Power

Specific Power

TARDEC has found that, “the real need is for the complete propulsion system to be power dense,” including the engine, transmission, cooling system, air filtration system, intake and exhaust ducting, controls, accessories, batteries, fuel systems, and final drives [1]. The Achatas Power opposed-piston engine has high specific power and, as important, its substantially lower fuel consumption and heat rejection to coolant greatly enhances the specific power of the power pack, especially cooling and fuel systems which consume large volumes.

RISK ELEMENTS AND MITIGATION

While opposed-piston engines eliminate many engine components that are among the most common to fail in conventional engines—cylinder head, cylinder head gaskets, exhaust valves, cams, etc.—they introduce new design features that have to be fully validated.

Wrist Pin Durability

Because wrist pins for two-stroke engines are primarily under continuous compressive load, it is challenging to adequately lubricate the bearing. Without a force reversal on the wrist pin, lubricating oil fails to migrate to all surfaces of the pin, leading to premature wear. The following figure shows a comparison between the wrist pin forces in 4-stroke and 2-stroke engines, illustrating the problem.

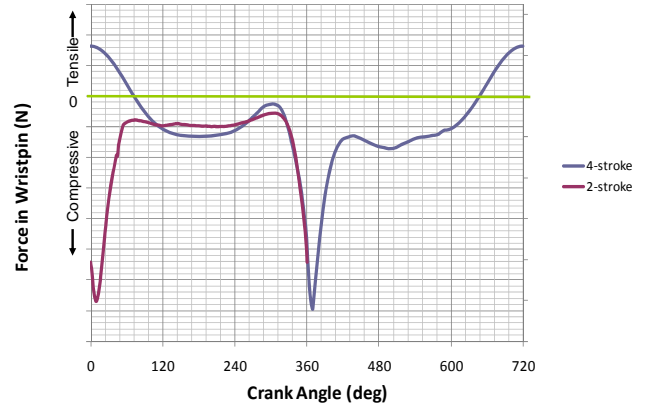

Figure 11: Wrist Pin Load Comparison: 4- vs. 2-stroke

To address this failure mode, a biaxial bearing, which is illustrated in Figure 12, has been designed and developed. This bearing design uses two distinct, non-concentric journals to carry the load. The motion and geometry of the pin and carrier alternately load and unload different portions of the bearing so that the full bearing is squeeze film lubricated in each engine cycle.

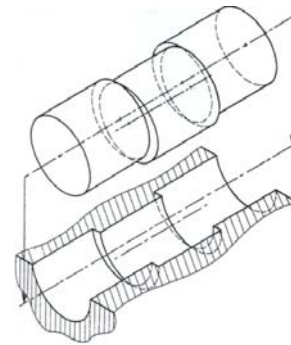

Figure 12: Bi-axial Wrist Pin Illustration

Similar designs have been used successfully on crosshead two-stroke marine engines and on the EMD 710 two-stroke locomotive engine now in production. The type of wrist pin is well-understood [5]. A photograph of a successfully-used EMD710 wrist pin is shown below.



Figure 13: EMD710 Bi-axial Wrist Pin with 18,000 Hours in Service

Additionally, experimentally-calibrated and proprietary analytical models have been developed to determine minimum oil film thickness of different bearing design alternatives which enable rapid design evolution. Currently, Achates Power has biaxial bearing designs in operation in an A48 engine configuration being developed for other engine programs.

Piston and Cylinder Thermal Management

Since two-stroke engines fire in every cylinder during every engine revolution, they tend to have high thermal loads on the piston and cylinders. The proposed power module design has several advantages over many other two-stroke engines:

- The very high thermal efficiency, described previously, results in less heat being transferred to the combustion chamber surface than in other 2-stroke engines.
- The Achates Power engine has moderate BMEP and gas temperatures compared to some two-stroke engines.
- Achates Power has extensive experience in managing the piston and cylinder thermal loads. Proven impingement cooling solutions for both pistons and cylinders have been developed, which are covered by multiple U.S. and foreign patents and patent applications (Lemke, Hoffman, Wahl, & Lee, 2008), (Lemke, McHargue, Wahl, & Lee, 2009).

Beyond this, management of piston and liner temperatures requires a total systems approach, including:

- Selection of the appropriate injector spray patterns and piston bowl geometries to reduce heat flux into the piston crown
- Port timing selections that manage trapped air charge temperatures
- Use of appropriate calibration settings, such as air/fuel ratios and beginning of injection timing
- Optimal flow rates of the piston cooling jets and fill ratios for the galleries.

One of the key cylinder cooling objectives is to maintain a uniform temperature axially along the bore to minimize bore distortion and allow use of lower friction piston rings. This is accomplished by introducing the impingement cooling along the outside circumference of the middle of the cylinder, which is the area of highest heat transfer. This also allows the coolant flows along the exhaust side and the intake side of the cylinder to be metered separately, recognizing that there will be higher heat transfer on the exhaust side.

Achates Power has published a technical paper SAE 2012-01-1215 "Cylinder Cooling for Improved Durability on an

Opposed-Piston Engine" on the topic at the 2012 SAE World Congress [6]. The paper describes the analytic methods to design and analyze cylinder cooling solutions. The method includes performing conjugate heat transfer analysis using computational fluid dynamics, accounting for the dynamic effects of swirl and piston motion. The paper also describes how alternative cooling jacket designs were analyzed and refined to find a robust solution.

Technical goals for maximum piston temperatures have been developed to prevent oil degradation, ring jacking and carbon build-up. Experimentally-calibrated and proprietary analytical models are used to evaluate thermal loading and thermal management of piston and cylinder design alternatives, which enables rapid design evolution.

Oil Consumption and Cylinder Durability

Ported engines have historically been known to have problems with excessive oil consumption, driven by a tradeoff between low oil consumption and acceptable cylinder and piston durability. The oil consumption goal for Achates Power for commercial engines is 0.1% of fuel (fuel specific oil consumption = 0.1%), well below what is required for most military applications.

Experimentally calibrated proprietary analytical models have been developed to determine oil consumption based on cylinder, piston and ring design, which enables rapid design evolution. A Da Vinci sulfur trace system is in use at Achates Power that enables the measurement of oil consumption in real-time [7].

Mitigation techniques to reduce oil consumption, as needed, include:

- Modifying oil ring tension
- Modifying scraper element conformability
- Modifying ring end gaps, end chamfers and land chamfers
- Modifying ring groove tilt, pinch, keystone angle, texture and flatness
- Modifying ring side clearance, cross sealing and side sealing
- Modifying volume behind ring and volume between rings
- Modifying bore texture, form after honing and form at operating temperature
- Modifying cylinder cooling design and operation to change liner temperature
- Utilizing cast iron liners with high graphite content

In addition, poorly designed ported engines have been known to have problems with piston ring clipping, where the ring makes metal-to-metal contact with a port timing edge. This contact abrades the material and eventually leads to scuffing or excessive wear of the liner. Achates Power has developed and tested a number of design solutions to mitigate this problem.

To mitigate this failure mode, experimentally calibrated proprietary analytical models have been developed to evaluate the ring clipping potential of different design alternatives, which enable rapid design evolution. Current mitigation actions have included:

- Reducing port widths to limit ring excursion
- Designing unique ring geometries common to production two-stroke engines. To limit contact stress, maximum radial acceleration of the ring is limited.

SUMMARY

The opposed-piston engine is the most thermally efficient internal combustion engine known, combining advantageous surface area/volume ratio, short combustion duration, higher ratio of specific heat and efficient scavenging. The architecture also has benefits of high specific power, light weight and low cost. Achates Power has modernized the architecture by mitigating the design challenges and designing a proprietary and patented combustion system that is clean and efficient. Achates Power has validated its engine designs through more than 3,000 hours of dynamometer testing.

REFERENCES

- [1] Raffa, C., Schwarz, E., Tasdemir, J., "Combat Vehicle Engine Selection Methodology Based on Vehicle Integration Considerations", SAE International Technical Paper 2005-01-1545, 2005, doi:10.4271/2005-01-1545.
- [2] Foster, D., Herold, R., Lemke, J., Regner, G., Wahl, M., "Thermodynamic Benefits of Opposed-Piston Two-Stroke Engines", SAE International Technical Paper 2011-01-2216, 2011, doi:10.4271/2011-01-2216.
- [3] Flint, M. and Pirault, J.P., "Opposed Piston Engines: Evolution, Use, and Future Applications", SAE International, Warrendale, PA ISBN 978-0-7680-1800-4, 2009.
- [4] Sandoval, D. and Heywood, J., "An Improved Friction Model for Spark-Ignition Engines", SAE International Technical Paper 2003-01-0725, 2003, doi:10.4271/2003-01-0725.
- [5] Wakuri, Y., Ono, S., & Soejima, M. (1982). On the Lubrication of Crosshead-pin Bearing with Eccentric Journal. *Bulletin of the JSME, Vol. 25, No. 206.*
- [6] Lee, P., Wahl, M., "Cylinder Cooling for Improved Durability on an Opposed-Piston Engine", SAE International Technical Paper 2012-01-1215, 2012, doi:10.4271/2012-01-1215.
- [7] Callahan, B., Froelund, K., Wahl, M., "Oil Consumption Measurements for a Modern Opposed-Piston Two-Stroke Diesel Engine", ASME Technical Paper, ICEF2011-60140, 2011.