

Characterizing the Performance of GPS Disciplined Oscillators with Respect to UTC(NIST)

Michael A. Lombardi, Andrew N. Novick, and Victor S. Zhang
Time and Frequency Division
National Institute of Standards and Technology (NIST)
Boulder, Colorado 80305

Abstract — Global Positioning System Disciplined Oscillators (GPSDOs) are now the primary standard of time and frequency at many laboratories and calibration facilities. They are typically accepted as self-calibrating standards, and their users generally assume that they meet the manufacturer's specifications. To gain a better understanding of the actual performance of GPSDOs, this paper presents a method of characterizing both their long and short-term performance that uses the UTC(NIST) time scale as a reference. It then describes how this method is used to characterize four GPSDOs, including two that use an oven controlled quartz oscillator (OCXO) as their time base, and two equipped with a rubidium oscillator. All four devices were simultaneously tested using the same antenna over two 60 d measurement intervals. During the first 60 d measurement, a previously surveyed antenna position was used and the same coordinates were applied to all four devices. During the second 60 d measurement, each GPSDO performed an independent survey of the antenna's position and applied its own coordinates. Both the timing output (1 pulse per second) and the frequency output (10 MHz) of each GPSDO was measured during both 60 d intervals. A low-noise dual mixer time difference system was used to characterize the short-term frequency stability of each device's 10 MHz output, and all measurement results are presented and summarized.

I. INTRODUCTION

Due to their excellent long-term accuracy and stability, and their low acquisition and maintenance costs when compared to cesium oscillators, GPS Disciplined Oscillators (GPSDOs) are widely used as standards of time and frequency. Standards laboratories and research facilities often rely on GPSDOs as their primary reference for time and frequency calibrations [1], and in some cases as the frequency reference for the Josephson voltage standard [2] and for the mode-locked lasers used in length metrology [3]. Cellular phone networks based on code division multiple access (CDMA) technology use GPSDOs to meet their 1 μ s timing requirement, and as the frequency reference for their base station carrier transmissions [4, 5, 6]. Electric power grids use time information from GPSDOs to rapidly locate faults [7]. These applications generally treat GPSDOs as self-calibrating standards, where it is assumed that the devices perform according to the manufacturer's

specification, and that they do not need to be periodically calibrated or compared to another standard.

Because GPSDOs are continuously adjusted to agree with signals broadcast by the GPS satellite constellation, it's true that they are self-calibrating standards. Even so, the performance of GPSDOs still differs by a significant amount from device to device, and some models are not suited for all applications. Specifications provided by the manufacturer might provide only a rough indication of their actual performance. Several published reports [8, 9, 10] have compared the performance of commercially available GPSDOs to internationally traceable time scales, but these studies were made prior to the deactivation of the Selective Availability (SA) program in May 2000, an event that improved the performance of most GPSDOs by a factor of five or more. This paper revisits the topic of GPSDO performance in the post-SA era by introducing a test procedure that measures both the short and long-term performance of GPSDOs. This test procedure was used to characterize the performance of four GPSDOs by measuring their accuracy and stability for both time and frequency with respect to the UTC(NIST) time scale located in Boulder, Colorado.

II. THE GPSDOs UNDER TEST

The four GPSDOs characterized in this report were chosen for two reasons: they were available to the authors, and they were believed to be a reasonable sample of models commonly used by government and industry. However, we are aware that this is not a comprehensive survey. We will not identify manufacturers or model numbers, but will instead refer to them as devices A, B, C, and D. Device A was designed for use in the telecommunications industry and formerly installed inside a CDMA base station; devices B and C are marketed as being suitable for a variety of applications; and device D is marketed primarily as a frequency standard for calibration and metrology laboratories. All devices provide a 1 pulse per second (pps) timing output, and at least one 10 MHz sine wave output for use as a frequency reference (devices C and D provide multiple 10 MHz outputs). Table I summarizes the features of the tested models.

Report Documentation Page

*Form Approved
OMB No. 0704-0188*

Public reporting burden for the collection of information is estimated to average 1 hour per response, including the time for reviewing instructions, searching existing data sources, gathering and maintaining the data needed, and completing and reviewing the collection of information. Send comments regarding this burden estimate or any other aspect of this collection of information, including suggestions for reducing this burden, to Washington Headquarters Services, Directorate for Information Operations and Reports, 1215 Jefferson Davis Highway, Suite 1204, Arlington VA 22202-4302. Respondents should be aware that notwithstanding any other provision of law, no person shall be subject to a penalty for failing to comply with a collection of information if it does not display a currently valid OMB control number.

1. REPORT DATE AUG 2005	2. REPORT TYPE	3. DATES COVERED 00-00-2005 to 00-00-2005			
4. TITLE AND SUBTITLE Characterizing the Performance of GPS Disciplined Oscillators with Respect to UTC(NIST)		5a. CONTRACT NUMBER			
		5b. GRANT NUMBER			
		5c. PROGRAM ELEMENT NUMBER			
6. AUTHOR(S)		5d. PROJECT NUMBER			
		5e. TASK NUMBER			
		5f. WORK UNIT NUMBER			
7. PERFORMING ORGANIZATION NAME(S) AND ADDRESS(ES) National Institute of Standards and Technology (NIST), Time and Frequency Division, Boulder, CO, 80305		8. PERFORMING ORGANIZATION REPORT NUMBER			
9. SPONSORING/MONITORING AGENCY NAME(S) AND ADDRESS(ES)		10. SPONSOR/MONITOR'S ACRONYM(S)			
		11. SPONSOR/MONITOR'S REPORT NUMBER(S)			
12. DISTRIBUTION/AVAILABILITY STATEMENT Approved for public release; distribution unlimited					
13. SUPPLEMENTARY NOTES Joint IEEE International Frequency Symposium and Precise Time and Time Interval (PTTI) Systems and Applications Meeting, 29-31 Aug 2005, Vancouver, BC, Canada					
14. ABSTRACT Global Positioning System Disciplined Oscillators (GPSDOs) are now the primary standard of time and frequency at many laboratories and calibration facilities. They are typically accepted as self-calibrating standards, and their users generally assume that they meet the manufacturer's specifications. To gain a better understanding of the actual performance of GPSDOs, this paper presents a method of characterizing both their long and short-term performance that uses the UTC(NIST) time scale as a reference. It then describes how this method is used to characterize four GPSDOs, including two that use an oven controlled quartz oscillator (OCXO) as their time base, and two equipped with a rubidium oscillator. All four devices were simultaneously tested using the same antenna over two 60 d measurement intervals. During the first 60 d measurement, a previously surveyed antenna position was used and the same coordinates were applied to all four devices. During the second 60 d measurement, each GPSDO performed an independent survey of the antenna's position and applied its own coordinates. Both the timing output (1 pulse per second) and the frequency output (10 MHz) of each GPSDO was measured during both 60 d intervals. A low-noise dual mixer time difference system was used to characterize the short-term frequency stability of each device's 10 MHz output, and all measurement results are presented and summarized.					
15. SUBJECT TERMS					
16. SECURITY CLASSIFICATION OF:			17. LIMITATION OF ABSTRACT Same as Report (SAR)	18. NUMBER OF PAGES 8	19a. NAME OF RESPONSIBLE PERSON
a. REPORT unclassified	b. ABSTRACT unclassified	c. THIS PAGE unclassified			

TABLE I. FEATURE SUMMARY OF THE TESTED GPSDOs

Feature	A	B	C	D
Satellite Channels	6	12	12	8
Selectable Mask Angle?	Yes, set to 10°	No, fixed at 5°	No, fixed at 10°	Yes, set to 10°
Delay resolution	1 ns	1 cm	1 ns	1 ns
Time Base	OCXO	OCXO	Rubidium	Rubidium
Displays Signal Strength?	Yes	No	No	Yes
Shows Satellites Being Tracked?	Yes	No	No	Yes

Two of the tested models (A and B) contain oven controlled crystal oscillator (OCXO) time bases, the other two (C and D) contain rubidium oscillator time bases, which increases their cost but provides them with potential performance advantages that might or might not be realized. One device (A) is capable of tracking six satellites at once, one (D) is capable of tracking eight, and the other two (B and C) can track 12 satellites simultaneously. All four devices allow the timing output of the device to be calibrated by entering a delay constant. However, while three of the devices predictably allow this number to be entered in time units (with 1 ns resolution), one device (B) requires entering the length of the antenna cable in centimeters and some conversion (and knowledge of the cable type) is necessary to equate centimeters to the actual time delay. All four devices have the ability to accept a position input by the user, and offer a “position hold” mode that allows them to operate in a stationary position without continuing to compute position fixes, a highly desirable feature for all GPSDOs used as time and frequency standards.

III. GPSDO INSTALLATION

Prior to testing, the GPSDOs were mounted in an equipment rack and connected to the same antenna through the use of an antenna splitter. The antenna was mounted on the rooftop of the NIST Boulder laboratories. The antenna is typical of those supplied by GPSDO manufacturers. It is cone shaped, and has a polycarbonate outer casing with a height of about 163 mm and a diameter of 90 mm. It has a relatively narrow bandwidth of ± 10 MHz around the 1575.42 MHz L1 carrier frequency and a gain that exceeds 30 dB, with 38 dB being typical for satellites at an elevation angle of 90°.

The antenna’s position was surveyed with respect to known geodetic survey markers and other GPS antennas used at NIST to contribute common-view data to

International Atomic Time (TAI). The latitude was calculated as 39° 59’ 44.291” N, the longitude as 105° 15’ 43.322” W, and the altitude as 1645.54 m, with respect to the GPS ellipsoid (WGS84). The estimated uncertainty of these coordinates is less than 20 cm. During the initial tests, these identical coordinates were entered into devices A, C, and D, all of which allow coordinate entry with a resolution of 1 milliarcsecond for latitude and longitude, and 1 cm for altitude. It should be noted, however, that slightly different numbers for latitude and longitude were used for device B (see Table III in Section VI), since that device has a position resolution of 1 microdegree, or 3.6 milliarcseconds. In this case, the coordinates entered for device B differ by about 4 cm from the known coordinates, an amount believed to be insignificant. The mask angle of each device was set to 10°, with the exception of device B, which uses a 5° mask angle that cannot be changed (Table I).

An 18.29 m coaxial cable (LMR-400) with a measured delay of 73 ns was used to connect the antenna to an 8-channel antenna splitter (only four channels were used). The splitter has its own power supply, and provides 5 V dc to the antenna through the antenna cable. According to the manufacturer, it introduces a group delay ranging from 3 to 4 ns across all outputs, so we estimate the mean delay contributed by the splitter to be 3.5 ns. Four identical cables, with a length of 0.94 m and a measured delay of 4.5 ns, were used to connect the splitter to the antenna inputs of the four GPSDOs. Therefore, we estimate the combined antenna cable/splitter delay as 81 ns (Table II).

IV. DESCRIPTION OF MEASUREMENT SYSTEMS

To perform a complete characterization, we decided that the time and frequency outputs (1 pps and 10 MHz) would need to be measured simultaneously, so we could determine, among other things, whether the two outputs were in phase with each other. To conduct a fair comparison, it was also decided that the devices should be tested simultaneously, so that each device had access to the same GPS satellites under the same atmospheric conditions. This required simultaneous data collection from eight measurement channels, including four 1 pps channels and four 10 MHz channels.

To meet the requirement of having four 1 pps channels, a PC-based time measurement system was built that used a four-port RS-232 interface card connected to four identical time interval counters (Fig. 1). Software was written to read all four ports every second, and to time tag and store each value. Thus, a nominal total of 86 400 data points were recorded from each GPSDO each day. Each counter reading was corrected in software for the cable delay between the UTC(NIST) time scale and our testing laboratory, a delay near 750 ns for all channels. The time tag was provided by the PC clock, which was periodically synchronized to the NIST Internet Time Service [11] so that better than 0.5 s time-of-day accuracy was continuously maintained.

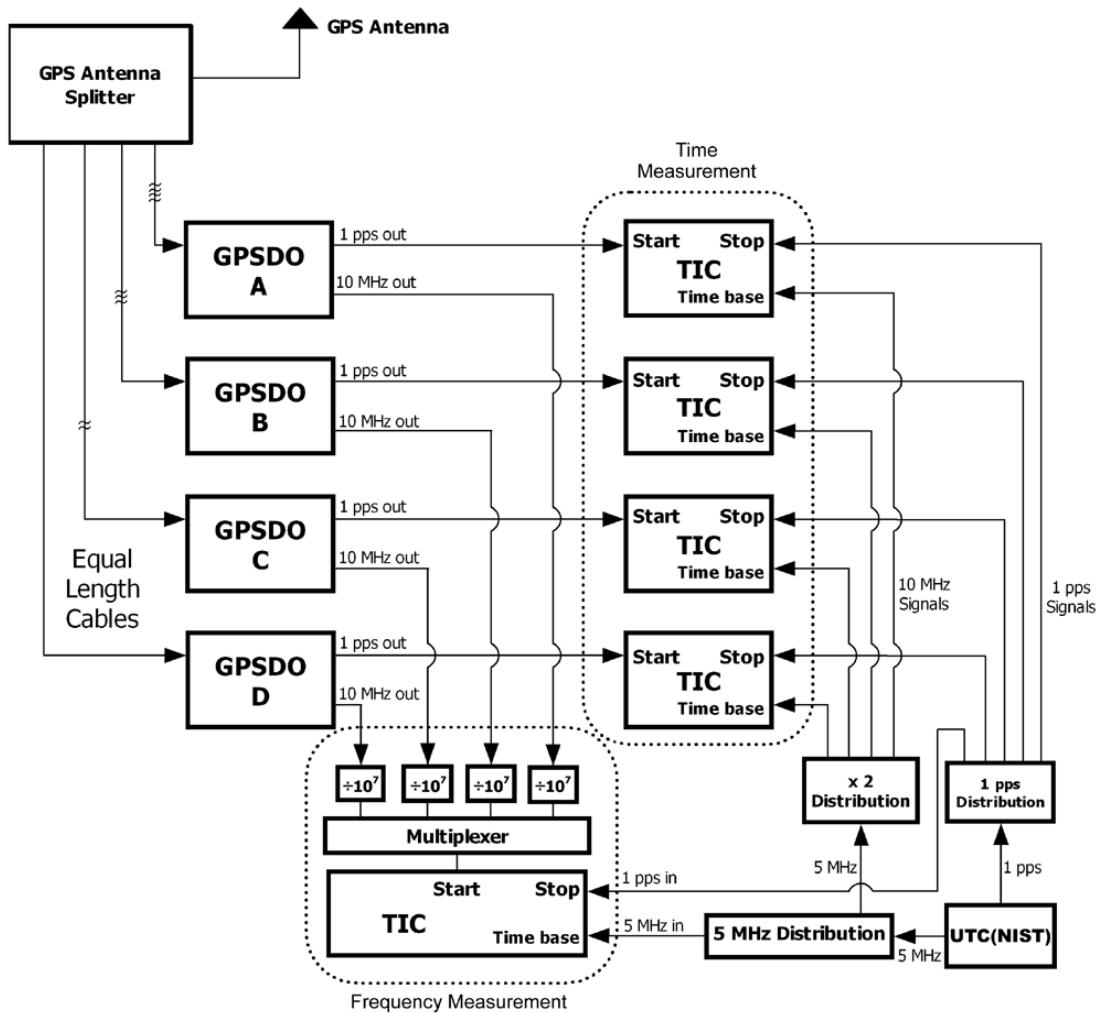

Figure 1. Block diagram of 1 pps and 10 MHz measurement systems used for long-term tests.

The four 10 MHz channels were provided by a measurement system identical to those used by subscribers of the NIST Frequency Measurement and Analysis Service (FMAS) [12]. The FMAS unit contains a time interval counter with single shot resolution of < 0.03 ns, and a start channel multiplexer that allows up to five inputs to be selected. All inputs to the multiplexer pass through software-configurable dividers. For our measurements, the dividers were configured to divide 10 MHz signals from each GPSDO by 10^7 , and then the multiplexer passed the resulting 1 pps signals to the counter in sequence (Fig. 1), with each count stopped by 1 pps from UTC(NIST). A fifth channel (not shown in Fig. 1) was used for diagnostics, so one reading was taken from each GPSDO every 5 s, and 1 h averages were stored. The results are given in Section VII.

We included a short-term frequency stability test in our characterization, because GPSDOs are often used to distribute frequency, an application where frequency stability at an averaging time of a few seconds or less is important. The two measurement systems described above have limited resolution, and can measure frequency stability

only to parts in 10^{10} or 10^{11} at $\tau = 1$ s. For this reason, a dual mixer time difference system with resolution near 10^{13} at $\tau = 1$ s [13] was used. The dual mixer system compared a 10 MHz signal derived from UTC(NIST) to a 10 MHz signal from each GPSDO. Ideally, these measurements would be made simultaneously using the same satellites and atmospheric conditions as was done with the long-term measurements. However, because only one dual mixer system was available, the four devices were tested sequentially, and the results are shown in Section VIII.

V. DELAY CALIBRATIONS

The characterization began with a delay calibration of each GPSDO, so that their on-time pulses would coincide with UTC(NIST). The 1 pps outputs from all four devices were simultaneously compared to UTC(NIST) for 7 d (02/25/05 to 03/03/05), and the mean time offset was calculated and entered into each device. This offset included delays in the GPSDO itself, delays in the antenna system and cables, and the time difference between GPS and UTC(NIST) during the calibration (Table II).

TABLE II. RESULTS (IN NANoseconds) OF THE GPSDO DELAY CALIBRATION.

Delay	A	B	C	D
Mean time offset , Device – UTC(NIST), 7 d average	-1283	-145	-193	-122
Antenna cables/splitter delay, D_1	81	81	81	81
Cable delay (1.575 m) from device to counter, D_2	7.5	7.5	7.5	7.5
Receiver/antenna delay, D_3	1189	51	99	28
Average UTC(NIST) delay (GPS – UTC(NIST)) during 7 d calibration interval, D_4	5.5	5.5	5.5	5.5
Delay constant entered into device, $D_1 + D_2 + D_3 + D_4$	1283	145	193	122

The results indicate the time accuracy that can be expected by users who calibrate their cable delays, but who lack access to another reference and cannot measure the internal delays of the GPSDO. After compensating for cable delays, B and D have an offset of < 100 ns with respect to UTC(NIST), and C is near the 100 ns specification. This indicates that some GPSDOs can provide time within 100 ns of UTC(NIST) if the cable delays are measured and entered, and if the antenna coordinates are known to within a few meters. However, A is an older unit whose internal delay is > 1 μ s. While delays this large are not believed to be common with newer models, it indicates that, unbeknownst to users, a GPSDO can possibly have an internal delay much larger than the cable delays.

VI. TIMING RESULTS WITH KNOWN COORDINATES AND SELF-SURVEYED ANTENNAS

The 1 pps outputs of the four GPSDOs were measured over the 60 d interval from 03/10/2005 (MJD 53439) through 05/08/2005 (MJD 53498). Data were recorded continuously (86 400 readings per day) from all four devices. However, a series of short power outages on MJDS 53442, 53489, and 53493 caused 74 s of data to be lost, since the distribution amplifier supplying UTC(NIST) was connected to a backup generator that required at least several seconds to respond after each outage. This did not impact the results, because the GPSDOs and measurement hardware were not interrupted. Since so much data were collected (5 183 926 data points), they were converted to 1 min averages, and a phase plot is provided in Fig. 2.

None of the devices appeared to lose lock during the test, and nearly all readings were within ± 50 ns of UTC(NIST). However, C had three unexplained phase excursions of > 140 ns and a number of smaller outliers. Device A had one outlier of about 150 ns, and D had one

exceeding 200 ns. Meanwhile, B had no visible outliers during the 60 d test. The mean time offset from UTC(NIST) was -8.07 ns for A, 1.40 ns for B, -2.12 ns for C, and 1.24 ns for D.

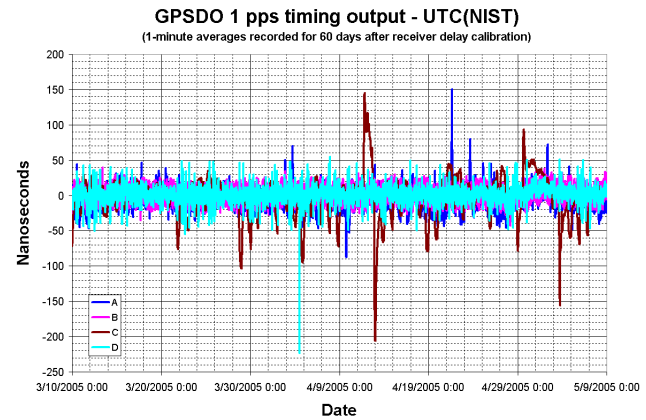

Figure 2. Phase plot of GPSDO 1 pps – UTC(NIST) using known antenna coordinates.

Most users do not have previously surveyed coordinates and thus rely on the GPSDO’s ability to survey its own antenna position. Thus, we decided to repeat the 60 d test after each device had completed its own antenna survey to obtain a better estimation of “real world” performance. All four devices have built-in antenna survey capability. Devices A, C, and D average position fixes for about 10 000 s, and while B allows the user to select the length of the survey, it was also set to 10 000 s for the sake of comparison. Each device simultaneously surveyed the same antenna (through the splitter described earlier), but the results were quite different, as summarized in Table III.

Nearly all of the error in the self-surveyed coordinates was due to the error in altitude, because averaging latitude and longitude values for 10 000 s tends to provide very good results. Altitude errors correlate directly to time errors at a ratio that can approach 3 ns per meter. During the self-survey, the altitude errors ranged from about 1.7 m for D to 23.2 m for A. If multiple surveys were performed, it is almost certain that A would do better on some attempts and that D would do worse, and that the average might vary considerably from the single result listed here. However, in the “real world” most users will perform only one survey (when the device is first installed) and accept whatever results they obtain as correct from that day forward.

A 60 d measurement using the self-surveyed coordinates was conducted from 05/20/2005 (MJD 53510) through 07/18/2005 (MJD 53569). Data were recorded continuously (86 400 readings per day) from all four devices. For the same reason noted earlier, a small amount of data (in this case 30 s) was lost due to short power outages on MJDS 53512 and 53520. As before, the 1 s data were converted to 1 min averages for analysis, and a phase plot is provided in Fig. 3.

TABLE III. GPSDO COORDINATES (KNOWN AND SELF-SURVEYED).

	A	B	C	D
Known coordinates entered into devices	39°59'44.291" N 105°15'43.322" W 1645.54 m	39°59'44.2896" N 105°15'43.3224" W 1645.54 m	39°59'44.291" N 105°15'43.322" W 1645.54 m	39°59'44.291" N 105°15'43.322" W 1645.54 m
Length of time required for antenna survey	Not specified, appeared to be 10 000 s	Selectable from 1 to 65000 s, 10 000 s selected	10 000 s	10 000 s
Coordinates obtained by device during antenna survey	39°59'44.276" N 105°15'43.262" W 1668.76 m	39°59'44.2896" N 105°15'43.344" W 1653.76 m	39°59'44.318" N 105°15'43.263" W 1650.54 m	39°59'44.320" N 105°15'43.289" W 1647.26 m
Error in altitude with respect to known coordinates	23.22 m	8.22 m	5.00 m	1.72 m
Total error in self-surveyed coordinates with respect to known coordinates	23.27 m	8.24 m	5.26 m	2.09 m

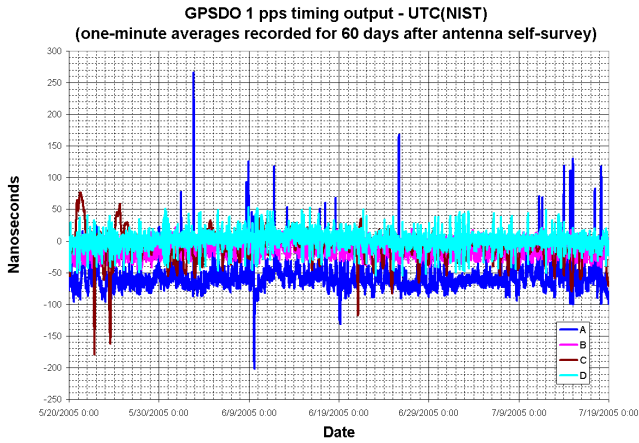

Figure 3. Phase plot of GPSDO 1 pps – UTC(NIST) using self-surveyed antenna coordinates.

Note that Fig. 2 shows the data set of all four devices to be centered near 0 with respect to UTC(NIST), since the devices had just been calibrated using the known antenna coordinates. After the self-survey, however, the mean time offset of each device has moved further away from 0, and the tracks from the four devices have separated from each other (Fig. 3). Device A is the most extreme example. The 23.2 m altitude error introduced by the antenna self-survey results in a mean time offset of -57.62 ns with respect to UTC(NIST). The mean time offset for the other devices was much smaller, -10.33 ns for B, -8.84 ns for C, and 1.02 ns for D. Note that the mean time offset for D was actually slightly smaller than with the known coordinates, despite the fact that the self-survey introduced an altitude error of about 1.7 m. This suggests that the uncertainty of our initial delay calibration is large enough to overlap the uncertainty introduced by the error in the antenna coordinates.

Fig. 3 also shows that the number of outliers for device A increased over the first 60 d run, with one outlier exceeding 250 ns, and a number of outliers exceeding 100 ns. In contrast, the number of outliers for C decreased slightly, but two outliers still exceeded 150 ns. Devices B and D have no visible outliers, with B making it through both 60 d tests without any obvious outliers. It is likely that the number of outliers was not related to the difference between known and self-surveyed coordinates, but rather to differences in GPS reception conditions on different days.

The time stability (time deviation, $\sigma_x(\tau)$) of each device was estimated at τ values ranging from 1 min to 8192 min (about 5.7 d) using the data collected from both 60 d runs. The results (in nanoseconds) are shown in Table IV, and Fig. 4 is a graph of the time deviation, produced using the known coordinates data set collected during the first 60 d run.

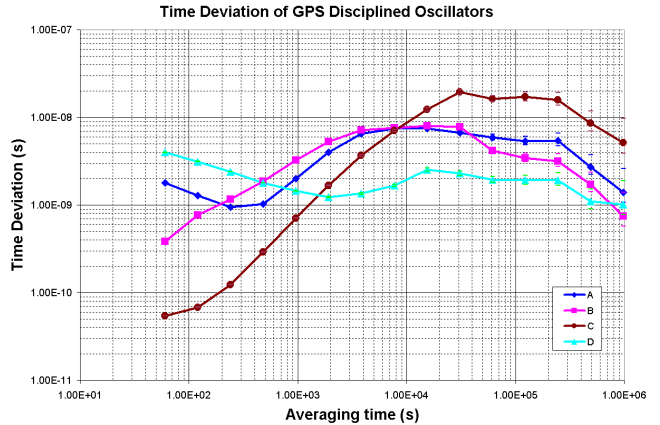

Figure 4. Time stability of GPSDO 1 pps outputs.

TABLE IV. TIME DEVIATIONS (NANOSECONDS) FOR KNOWN AND SELF-SURVEYED ANTENNA COORDINATES.

Minutes	A		B		C		D	
	KC	SS	KC	SS	KC	SS	KC	SS
1	1.80	1.80	0.38	0.35	0.05	0.05	3.99	4.16
2	1.29	1.28	0.77	0.70	0.07	0.06	3.15	3.25
4	0.96	1.03	1.17	1.13	0.12	0.11	2.41	2.39
8	1.04	2.01	1.89	2.28	0.29	0.35	1.80	1.61
16	2.02	4.56	3.30	3.70	0.72	0.68	1.46	1.32
32	4.05	8.68	5.33	5.94	1.69	1.69	1.25	1.10
64	6.61	13.2	7.35	8.43	3.73	5.34	1.38	1.45
128	7.67	12.4	7.79	8.22	7.25	9.67	1.73	2.09
256	7.83	11.5	8.39	7.81	12.8	14.9	2.63	2.50
512	7.10	9.26	8.31	4.64	20.7	12.6	2.43	1.85
1024	6.40	8.64	4.55	3.75	17.7	11.7	2.13	1.90
2048	6.05	4.61	3.90	2.67	19.4	8.42	2.17	1.36
4096	6.56	4.01	3.81	2.43	19.2	6.46	2.34	2.41
8192	3.74	8.58	2.38	7.96	11.9	7.75	1.53	6.87

We expected the time stability to be approximately the same using both known (KC) and self-surveyed (SS) antenna coordinates at short averaging times, reflecting the stability of the time base oscillator, but to change significantly with both coordinate sets when the GPS disciplining begins. This was evident in the case of C, which produced sub-nanosecond stability numbers until τ exceeded 16 min, when the GPS time corrections apparently began to be applied. However, D also includes a rubidium time base, and had the worst time stability of any of the four units until τ exceeded 4 min. Even so, the time deviation for D remained fairly flat across the entire range (Fig. 4), with no obvious point where GPS corrections begin. An examination of the raw 1 pps data revealed a “sawtooth” like phase pattern with an ambiguity near ± 50 ns. This appears to be the raw output of a commercial GPS timing engine [12, 14]. Thus, we assume that the 1 pps output for D is not derived from the rubidium time base. Device A also appears to get its timing output from a source that lacks the short-term stability of its OCXO time base, but it does not look identical to the raw output of the GPS timing engine, so perhaps an occasional correction from the time base is being applied.

VII. FREQUENCY RESULTS WITH KNOWN COORDINATES AND SELF-SURVEYED ANTENNAS

During the two 60 d measurements of the timing outputs, the 10 MHz outputs were simultaneously measured using the FMAS unit described in Section IV. The two 60 d frequency measurements produced similar results, and only results from the second run (Fig. 5) are shown here, because while the altitude errors introduced by the self-survey

significantly change the time offset (Fig. 3), they do not significantly change the frequency.

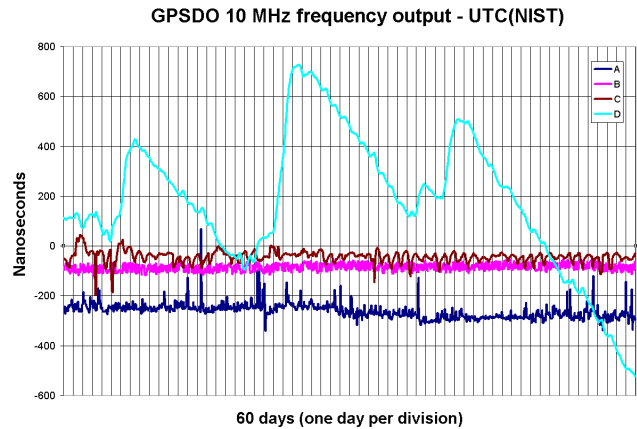

Figure 5. GPSDO 10 MHz – UTC(NIST) using self-surveyed coordinates.

As noted in the last section, D has a 1 pps output that is not derived from its time base oscillator, and by comparing the phase “signature” of Fig. 3 and 5, it is obvious that the frequency and time outputs of D are not in phase. The phase of D does not closely track the GPS signals, and it appears that the rubidium oscillator is allowed free run most of the time, with steering corrections occasionally applied. The resulting peak-to-peak phase variation exceeds 1 μ s, much larger than any of the other devices. Although less obvious, it appears that the 10 MHz output from A is also not in phase with its timing output, since the outliers appear in different places. Both examples illustrate that GPSDOs

can differ from cesium and rubidium standards, whose outputs are typically in phase with each other.

Table V and Fig. 6 show the long-term frequency stability of the 10 MHz outputs, as estimated with the Allan deviation, $\sigma_y(\tau)$, at τ values ranging from 1 h to 256 h. Device D exhibited the best frequency stability at 1 h, reaching 2.8×10^{-13} , and A, B, and C all reach stabilities of $< 5 \times 10^{-13}$ at $\tau = 1$ d and below 1×10^{-13} at $\tau = 5$ d, better than what most GPSDO manufacturers specify, and predictably much lower than what could be obtained with “undisciplined” OCXO or rubidium oscillators. Device D did not fare as well as the others at long averaging times, because its curious steering method (Fig. 5) does not take advantage of the excellent long-term stability of the signals from the GPS satellites.

TABLE V. LONG-TERM FREQUENCY STABILITY ESTIMATES.

Hours	A	B	C	D
1	1.56E-12	4.62E-12	6.75E-12	2.83E-13
2	1.80E-12	2.91E-12	4.61E-12	3.82E-13
4	1.62E-12	1.53E-12	2.38E-12	5.55E-13
8	1.25E-12	8.46E-13	1.28E-12	7.01E-13
16	6.65E-13	4.22E-13	6.32E-13	6.75E-13
32	3.78E-13	2.17E-13	3.26E-13	7.68E-13
64	1.77E-13	1.04E-13	1.64E-13	7.39E-13
128	7.46E-14	5.06E-14	4.56E-14	7.37E-13
256	4.02E-14	2.69E-14	4.56E-14	5.17E-13

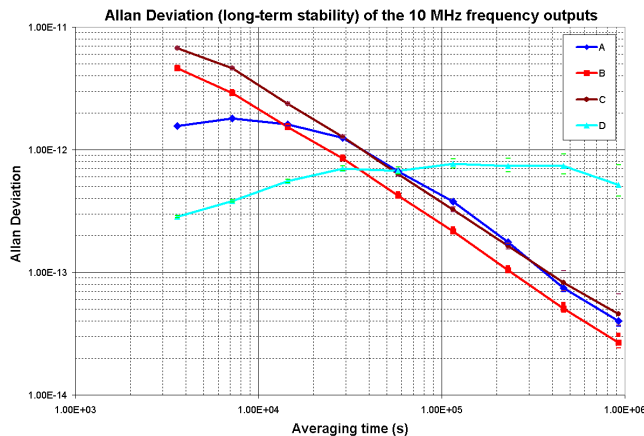

Figure 6. Long-term frequency stability of GPSDO 10 MHz outputs.

VIII. SHORT-TERM FREQUENCY STABILITY RESULTS

The short-term frequency stability of each device was measured with the dual mixer time difference system described in Section IV. Each device was tested for 1 d so that a large number of samples could be obtained. The test was repeated twice, first with the self-surveyed coordinates and then with the known coordinates, but the results were

nearly identical, because GPS disciplining does not occur at short averaging times and the measurement simply reveals the stability of the time base. The Allan deviation estimates for τ values spaced at 10 s intervals are listed in Table VI.

TABLE VI. SHORT-TERM FREQUENCY STABILITY ESTIMATES.

Seconds	A	B	C	D
1	1.21E-12	3.61E-12	5.92E-12	7.02E-12
10	1.13E-12	6.57E-12	1.69E-12	2.62E-12
20	1.45E-12	8.46E-12	1.26E-12	2.86E-12
30	1.73E-12	9.93E-12	1.07E-12	3.04E-12
40	1.98E-12	1.11E-11	9.80E-13	3.04E-12
50	2.21E-12	1.21E-11	9.26E-13	2.87E-12
60	2.41E-12	1.28E-11	8.82E-13	2.56E-12
70	2.61E-12	1.33E-11	8.55E-13	2.18E-12
80	2.79E-12	1.37E-11	8.46E-13	1.78E-12
90	2.98E-12	1.39E-11	8.50E-13	1.39E-12
100	3.13E-12	1.40E-11	8.52E-13	1.15E-12

Fig. 7 provides a graph showing all τ values from 1 to 100 s. As might be expected, the OCXO time bases in A and B had the best stability at $\tau = 1$ s, but the advantage of a rubidium time base is made evident at longer averaging times, with C’s stability dropping below A at an averaging time of about 15 s, and D dropping below A after about 1 min of averaging. Device B’s time base proved to be the least stable, with both rubidium models dropping below B after about 3 s of averaging. The most stable time base belonged to C, which dropped below 1×10^{-12} when τ was near 40 s, and stayed there for the duration of the test.

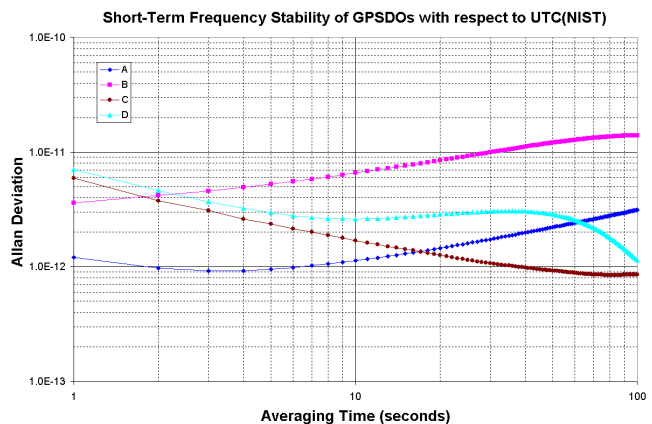

Figure 7. Short-term frequency stability of GPSDO 10 MHz outputs.

IX. SUMMARY

GPSDOs serve as excellent time and frequency standards that are indispensable to a wide variety of measurements and applications, and some technologies would simply not be possible without them. Some models

can provide time accurate to within 100 ns of UTC(NIST) after a simple calibration of the cable delays, can distribute frequency with short-term stability measured in parts in 10^{12} at $\tau = 1$ s; and since they are ultimately steered by signals from the GPS satellites, the very long-term stability of most GPSDOs is exceptional. However, the performance of GPSDOs can differ by a significant amount from device to device, and some models will not meet all requirements. None of the devices characterized in this report excelled in all areas. Several potential problems are worth noting: the internal delays of a device can be much larger than the cable delays (A), antenna self-surveys can introduce large timing errors (A), some devices have occasional phase excursions exceeding 100 ns for no obvious reason (A, C, D), some devices lack user interface features that might be necessary for diagnostics, such as signal strength displays or satellite tracking information (B, C), some devices employ non-conventional methods of entering coordinates and cable delays (B), some devices only discipline the oscillator at very long intervals and do not closely track the signals from the GPS satellites (D), and some devices have time and frequency outputs that are not in phase with each other (A, D). Users should be aware that the specifications provided by the manufacturer might provide only a rough indication of a GPSDO's actual performance. If better knowledge of the performance is required, it is advisable to have the device characterized by NIST, or by another laboratory that maintains an internationally traceable time scale.

REFERENCES

- [1] M. A. Lombardi, L. M. Nelson, A. N. Novick, and V. S. Zhang, "Time and frequency measurements using the Global Positioning System," *Cal Lab: International Journal of Metrology*, vol. 8, no. 3, July-September 2001, pp. 26-33..
- [2] Y. Tang, M. A. Lombardi, D. A. Howe, "Frequency uncertainty analysis for Josephson voltage standard", in *2004 Conf. Precision Electromagnetic Measurements Digest*, London, UK, June 2004, pp. 338-339.
- [3] R. W. Fox, S. A. Diddams, A. Bartels, and L. Hollberg, "Optical frequency measurements with the global positioning system: tests with an iodine-stabilized He-Ne laser", *Applied Optics*, vol. 44, no. 1, January 2005, pp. 113-120.
- [4] "Mobile station-base station compatibility standard for wideband spread spectrum cellular systems," *TIA/EIA Standard 95-B*, Arlington, VA: Telecommunications Industry Association, March 1999.
- [5] "Recommended minimum performance standards for base stations supporting dual mode spread spectrum systems," *TIA/EIA Standard 97-D*, Arlington, VA: Telecommunications Industry Association, June 2001.
- [6] B. M. Penrod, "A new class of precision UTC and frequency reference using IS-95 CDMA base station transmissions", in *Proceedings of the 33rd Annual Precise Time and Time Interval Meeting (PTTI)*, December 2001, pp. 279-291.
- [7] H. Lee and A. N. Mousa, "GPS travelling wave fault locator systems: investigation into the anomalous measurements related to lightning strikes", *IEEE Transactions on Power Delivery*, vol. 11, no. 3, July 1996, pp. 1214-1223.
- [8] F. Cordara and V. Pettiti, "GPS disciplined oscillators for traceability to the Italian time standard", in *Proceedings of the 27th Annual Precise Time and Time Interval Meeting (PTTI)*, November 1995, pp. 113-124.
- [9] J. A. Davis and J. M. Furlong, "Report on the study to determine the suitability of GPS disciplined oscillators as time and frequency standards traceable to the UK national time scale UTC(NPL)," *National Physical Laboratory Report CTM 1*, June 1997.
- [10] V. Pettiti and F. Cordara, "Short-term characterization of GPS disciplined oscillators and field trial of Italian calibration centers," in *Proc. Joint Meeting of the European Frequency and Time Forum and the IEEE International Frequency Control Symposium*, April 1999, pp. 404-407..
- [11] J. Levine, M. A. Lombardi, and A. N. Novick, "NIST computer time services: Internet Time Service (ITS), Automated Computer Time Service (ACTS), and time.gov web sites", *National Institute of Standards and Technology Special Publication 250-59*, May 2002.
- [12] M. A. Lombardi, "Remote frequency calibrations: The NIST frequency measurement and analysis service", *National Institute of Standards and Technology Special Publication 250-29*, June 2004.
- [13] L. Sojdr, J. Cermak, and G. Brida, "Comparison of High-Precision Frequency-Stability Measurement Systems", in *Proceedings of 2003 IEEE International Frequency Control Symposium*, May 2003, pp. 317-325.
- [14] J. B. Bullock, T. M. King, H. L. Kennedy, E. D. Berry, and G. Zanfino, "Test Results and Analysis of a Low Cost Core GPS Receiver for Time Transfer Applications," in *Proceedings of 1997 IEEE International Frequency Control Symposium*, May 1997, pp. 314-322..