

NACA TN 2525

NATIONAL ADVISORY COMMITTEE FOR AERONAUTICS

TECHNICAL NOTE 2525

THE EFFECT OF RATE OF CHANGE OF ANGLE OF ATTACK
ON THE MAXIMUM LIFT COEFFICIENT
OF A PURSUIT AIRPLANE

By Burnett L. Gadeberg

Ames Aeronautical Laboratory
Moffett Field, Calif.

Reproduced From
Best Available Copy



Washington
October 1951

DISTRIBUTION STATEMENT A
Approved for Public Release
Distribution Unlimited

20000731 100

DTIC QUALITY INSPECTED 4

AGM00-10-3107

1

NATIONAL ADVISORY COMMITTEE FOR AERONAUTICS

TECHNICAL NOTE 2525

THE EFFECT OF RATE OF CHANGE OF ANGLE OF ATTACK

ON THE MAXIMUM LIFT COEFFICIENT

OF A PURSUIT AIRPLANE¹

By Burnett L. Gadeberg

SUMMARY

The effect of rate of change of angle of attack on the maximum lift coefficient of a pursuit airplane equipped with a low-drag-type wing has been investigated in stalls of varying abruptness over the Mach number range from 0.18 to 0.49 and Reynolds number range from 6.1 to 13.4 million.

The maximum lift coefficients were found to increase linearly with increasing rate of change of angle of attack per chord length of travel up to the maximum rate attained in the tests (0.66° per chord length of travel) in contradistinction to the results of the flight tests of two other airplanes.

The tests indicated that the Mach and Reynolds numbers effects were of sufficient importance to produce more than a twofold variation in the increment of $C_{l_{max}}$ due to a given rate of change of angle of attack.

INTRODUCTION

To provide data on the effect of abrupt changes of angle of attack on the maximum lift characteristics of airplanes, flight tests have been conducted on three airplanes at the Ames Aeronautical Laboratory. The results of one of these investigations on an airplane with low-drag wing sections have been presented in reference 1. The results of another, an airplane with conventional wing sections, have been presented in reference 2. The present report presents results of the third investigation, on an airplane with a low-drag wing, and discusses the effect of abrupt changes in angle of attack in greater detail than the other two.

¹Supersedes NACA RM A8130, "The Effect of Rate of Change of Angle of Attack on the Maximum Lift Coefficient of a Pursuit Airplane" by Burnett L. Gadeberg, 1948.

The investigation was limited in scope in that the effect of rate of change of angle of attack on the maximum lift coefficient was investigated over the relatively low Mach number range from 0.18 to 0.49, Reynolds number range from 6.1 to 13.4 million, and rate of change of angle-of-attack range from that occurring in gradual stalls to that equivalent to 0.66° per chord length of travel.

SYMBOLS

A_{ZS}	normal acceleration factor at the stall, the ratio of the net aerodynamic force along the Z axis (positive when directed upward) to the weight of the airplane
$C_{L_{max}}$	airplane maximum lift coefficient
$\left(\frac{\bar{c}}{V}\right) \left(\frac{d\alpha}{dt}\right)$	pitching parameter, degrees per chord length of travel
\bar{c}	mean aerodynamic chord (80.17 in. per manufacturer's specification)
g	acceleration of gravity, feet per second squared
K	$\frac{d(C_{L_{max}})}{d\left(\frac{\bar{c}}{V} \frac{d\alpha}{dt}\right)}$, per degree
q	dynamic pressure at the stall, pounds per square foot
S	wing area, square feet
V	true airspeed, feet per second
V_i	indicated airspeed, miles per hour
W	weight of airplane, pounds
$\frac{d\alpha}{dt}$	rate of change of angle of attack, degrees per second
θ	flight-path angle, degrees
ϕ	angle of bank, degrees
ω	airplane pitching velocity due to flight path curvature, radians per second

DESCRIPTION OF THE AIRPLANE

The test airplane was a single-place, single-engine, low-wing, cantilever monoplane. Figure 1 is a two-view drawing of the airplane and figure 2 shows the airplane as instrumented for the flight tests. General details of the airplane as tested are as follows:

Engine V-1650-9

Propeller (hydromatic)

Diameter 11 ft 1 in.

Number of blades four

Weight at take-off 8660 lb

Center-of-gravity position at take-off 25 percent M.A.C.

Wing

Span 37.03 ft

Area 235.75 sq ft

Aspect ratio 5.82

Taper ratio 2.19

Incidence (root) 1°

Dihedral (25-percent chord) 5°

Sweepback (leading edge) 3°40'

Mean aerodynamic chord 80.17 in.

Airfoil

Root NACA 66,2-(1.8)(15.5)(a = 0.6)

Tip NACA 66,1-(1.8)(12)(a = 0.6)

Horizontal-tail surfaces

Span 14.65 ft

Area 48.35 sq ft

Incidence 1/2°

INSTRUMENTATION

Standard NACA photographically recording flight instruments were used to determine, as a function of time, the following variables: airspeed, pressure altitude, normal acceleration, and pitching velocity. The pitch and roll angles of the airplane relative to the horizontal plane were ascertained from camera records of the indications of an

attitude gyroscope. The swiveling head used for the measurement of airspeed and altitude was mounted on a boom one chord length ahead of the left wing tip and the installation was calibrated for position error. True airspeed was determined by the use of free-air temperatures obtained from radio-sonde observations taken during the day of each flight.

TESTS AND RESULTS

A series of stalls, varying in degree of abruptness of pitch-up, were executed at each of three altitudes and five airspeeds. The altitudes and airspeeds were 5,000, 15,000, and 25,000 feet and 125, 150, 175, 200, and 225 miles per hour. The altitude and airspeed during each series of stalls were maintained as closely as possible to minimize the variation of Mach and Reynolds numbers at which each series was conducted. The Mach and Reynolds number ranges over which the stalls were performed at each of the test altitudes are shown in figure 3.

Gradual stalls representing the slowest practical approach to the limit lift coefficient, in the opinion of the pilot, were performed from spiral turns in which the turn was gradually tightened to increase the lift and gradually steepened to maintain the proper indicated airspeed. The altitudes from which the turns were started were coordinated by the pilot with the rate of tightening of the turns so that the stalls occurred at the desired altitudes.

The abrupt stalls were made by flying the airplane in a steady spiral turn at the desired airspeed at an angle of attack below that required for a gradual stall,² and then as the desired altitude was approached the stick was moved sharply rearward until the airplane stalled. The procedure was then repeated with increasing degrees of abruptness until the severity of the maneuver was the maximum which the pilot cared to experience.

All stalls were made with the flap and gear up, cockpit canopy closed, power off, propeller governing, and with the oil and engine coolant shutters set to operate automatically.

²Care was taken to keep this initial steady-state condition at a lift coefficient of less than 60 percent of the steady-state $C_{L_{max}}$. In this way it was assured that a partially separated boundary layer would not build up previous to initiating the abrupt stall maneuver. Any premature thickening of the boundary layer would have modified the abrupt stall $C_{L_{max}}$, since after the pitch-up was initiated the time required to complete the thickening of the boundary layer to the condition of instability and separation would have been reduced.

The results of the stall tests are presented in figures 4, 5, and 6 for 5,000 feet, 15,000 feet, and 25,000 feet altitude, respectively. Each figure shows the values of maximum lift coefficient measured in the stalls plotted as a function of the rate of change of angle of attack for five values of Mach number.

The ordinates of the curves (maximum lift coefficient) were computed from the equation

$$C_{L_{\max}} = \frac{WA_{ZS}}{qS}$$

It is seen from the equation that the lift was assumed equal to the normal force WA_{ZS} . Although this is not rigorous, since the lift is a function of the normal and longitudinal accelerations as well as the angle of attack of the airplane, it was determined that the maximum deviation was only of the order of 5 percent.

The time at which the maximum lift coefficient was obtained during the tests was determined from the film records. In most cases, time histories of the stall tests were plotted. From these time histories, it was determined that the elevator had not reached the maximum up-position until after the lift coefficient had reached a maximum. It was then assumed that the maximum lift coefficient had not been limited by either the pilot, the travel of the elevator control surface, or the stability of the airplane.

Although the propeller and tail-surface lift components affect the measurement of the wing lift coefficient of an airplane in flight, these were neglected and use was made of the airplane lift coefficient. The difference between the two was estimated to amount to less than 2 percent of the measured values.

The abscissa of the curves is the parameter, representing the change in angle of attack per chord length of travel,

$$\left(\frac{\bar{c}}{V} \right) \left(\frac{d\alpha}{dt} \right)$$

Since the total pitching velocity of an airplane is composed of the pitching velocity due to the flight path and the rate of change of angle of attack, the latter parameter was determined by taking the difference between the maximum measured total pitching velocity and the calculated pitching velocity due to the flight path. This maximum pitching velocity was attained 6 to 12 wing-chord lengths of travel before the maximum lift coefficient was reached. Since the circulation of an airfoil starting from rest is nearly 80 percent of the final value after six chord lengths of travel, it would appear that the circulation would be

well established at the time the stall occurred. The pitching velocity ω due to the flight path was calculated from the equation:

$$\omega = \frac{g}{V} (AZ_S - \cos \theta \cos \phi)$$

DISCUSSION

The data presented in figures 4, 5, and 6 (describing the maximum lift coefficients attainable in stalls of varying abruptness at various speeds and altitudes) indicate that the maximum lift coefficient increases linearly with the pitching parameter $(\bar{c}/V)(d\alpha/dt)$ up to the limit of the test data. This is in contradistinction to the flight-test results indicated in references 1 to 3. These reports indicate that, for three airplanes with configurations similar to the present test airplane, the maximum lift coefficient reaches a limit with increasing abruptness of the stall maneuver, and that subsequent increases in the pitching parameter provide no further increases in $C_{L_{max}}$.

In reference 1 it is shown that, above values of the pitching parameter of approximately 0.5, the curves of $C_{L_{max}}$ increase but very little. Reference 3 indicates that this same phenomenon takes place at the relatively low value of approximately 0.1 for the pitching parameter. Although the values of the pitching parameter for the tests reported herein were carried to 0.66, no decrease of the slopes of the curves is noticeable.

The slopes of the curves of figures 4, 5, and 6 have been plotted in figure 7 to show the variation with Mach number at constant altitudes of the effect of rate of change of angle of attack on the maximum lift coefficient K . The data from figure 7 were then cross-plotted and combined with data from figure 3 to produce figures 8 and 9.

Figure 8 indicates that, for a constant Mach number within the range of the tests, the variation of the maximum lift coefficient with rate of change of angle of attack K first decreases and then increases with increasing Reynolds numbers. The minimum value of K is a function of Mach number and occurs at the lower Reynolds numbers for the lower Mach numbers.

Figure 9 indicates similarly that the values of K , at a constant Reynolds number, decreases and then increases with increasing values of Mach numbers. Here, too, the minimum values of K occur at the lower Mach numbers for the lower Reynolds numbers. Although the data are not as complete as desirable, it appears from figure 9 that, above about 0.32 Mach number, Reynolds number has less influence on the value of K than it does at the lower Mach numbers.

CONCLUSIONS

From tests of the effect of Mach and Reynolds numbers on the variation of maximum lift of a pursuit airplane in stalls of varying abruptness, it has been found that:

1. The maximum lift coefficient increased approximately linearly with rate of change of angle of attack to the limits of the tests (tests carried to values of $(c/V)(d\alpha/dt)$ of 0.66). This was in contradistinction to the results of previous flight tests of three other airplanes.
2. The combined effects of Mach and Reynolds numbers caused the rate of change of maximum lift coefficient with rate of change of angle of attack to vary from approximately 0.25 to 0.70.
3. Above a Mach number of approximately 0.32, Reynolds number had less effect on the rate of change of maximum lift coefficient with rate of change of angle of attack than at lower Mach numbers.

Ames Aeronautical Laboratory,
National Advisory Committee for Aeronautics,
Moffett Field, Calif., Sept. 6, 1951.

REFERENCES

1. Spreiter, John R., Galster, George M., and Blair, William K.: Effect of Mach and Reynolds Numbers on the Maximum Lift Coefficient Obtainable in Gradual and Abrupt Stalls of a Pursuit Airplane Equipped with a Low-Drag Wing. NACA MR A5G06, 1945.
2. Spreiter, John R., and Steffen, Paul J.: An NACA Flight and Wind-Tunnel Investigation of Maximum Lift as Affected by Variations of Mach and Reynolds Numbers. (For presentation at S.A.E. National Aeronautic Meeting (Spring), April 3-5, 1946, Hotel New Yorker, N.Y.) S.A.E. Preprint.
3. Mayer, John P.: Effect of Mach Number on the Maximum Lift and Buffeting Boundary Determined in Flight on a North American P-51D Airplane. NACA RM L6110, 1947.

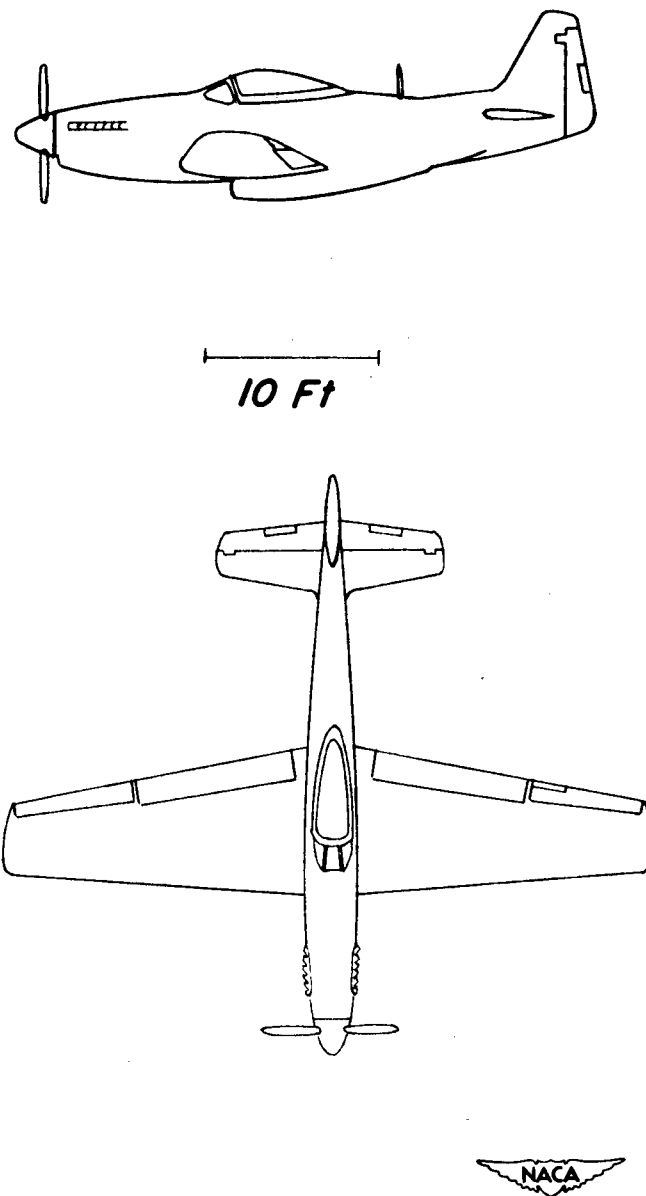

Figure 1.- Two-view drawing of the test airplane.

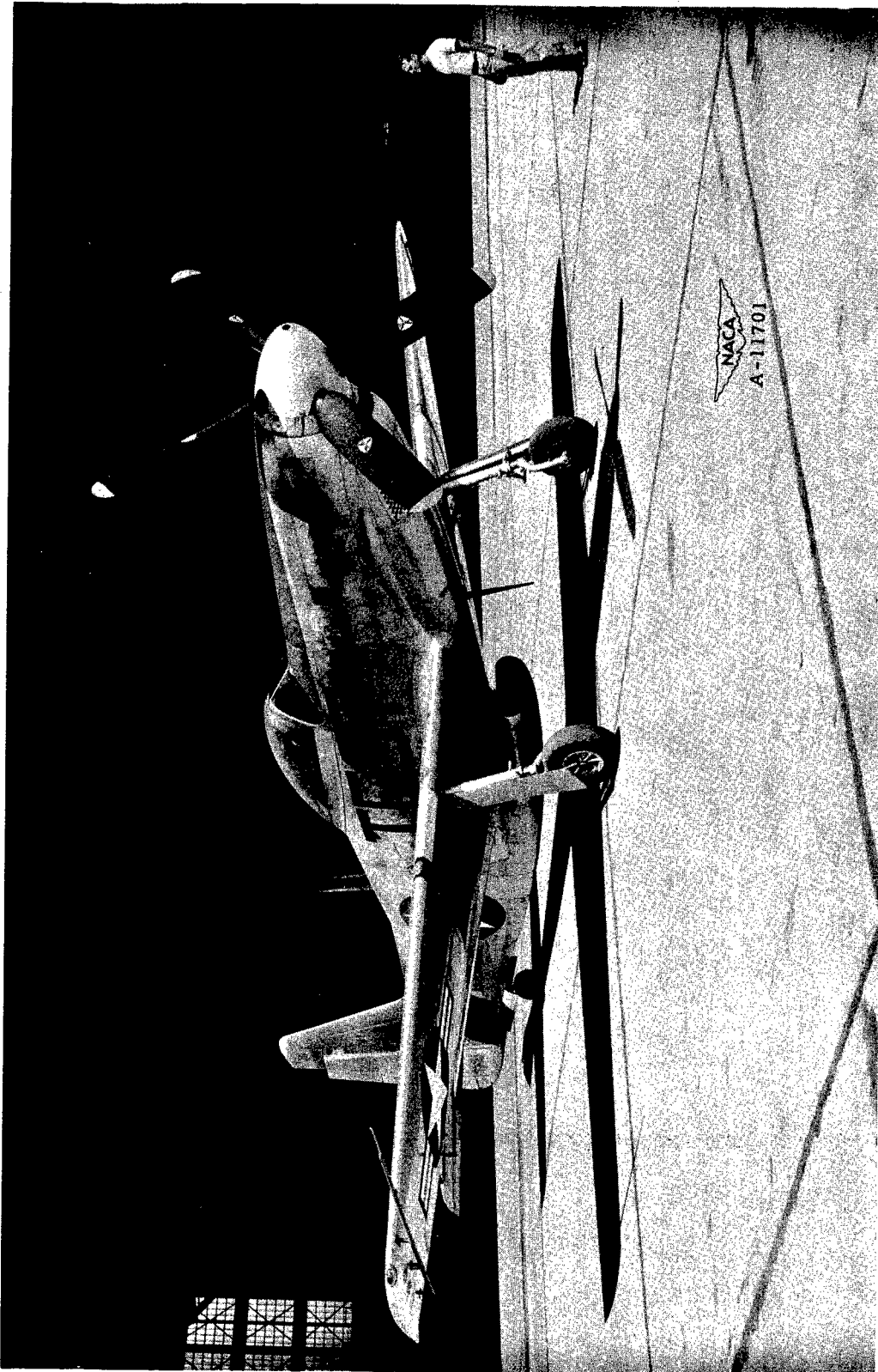

Figure 2.- Photograph of the test airplane as instrumented for test flights.

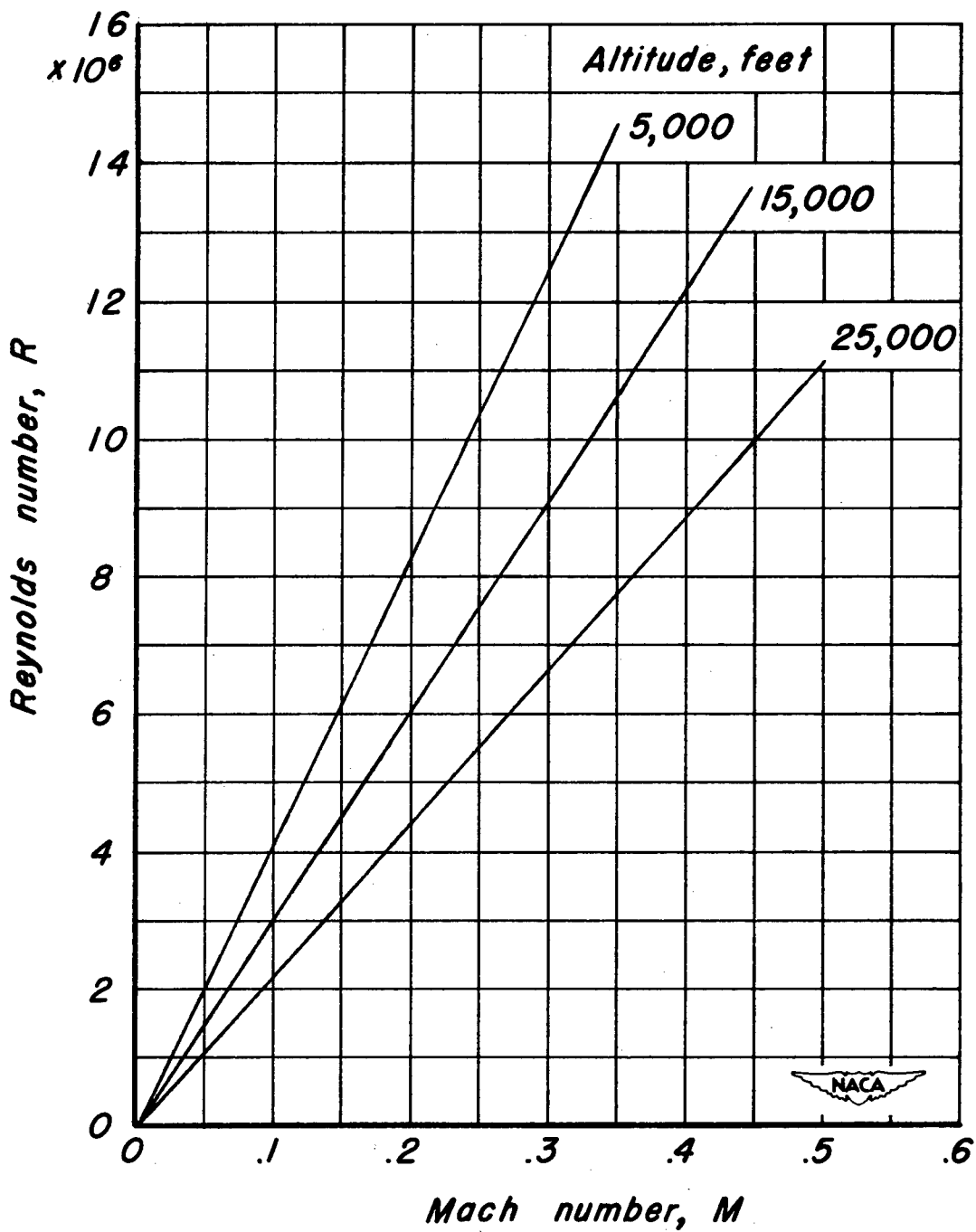

Figure 3.- Variation of Reynolds number with Mach number occurring during the flight tests.

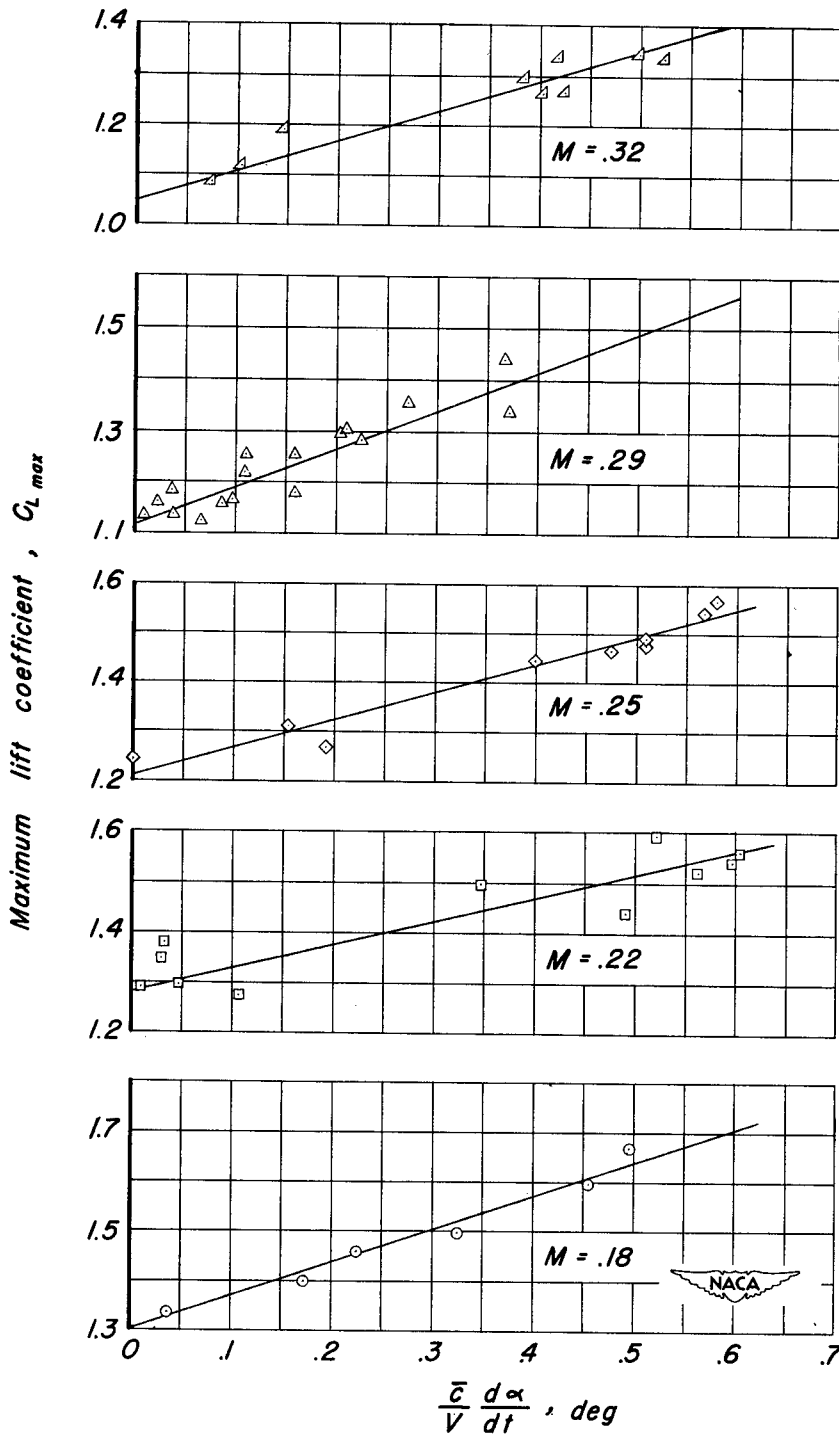

Figure 4.- The effect of rate of change of angle of attack on maximum lift coefficient at 5,000 feet altitude.

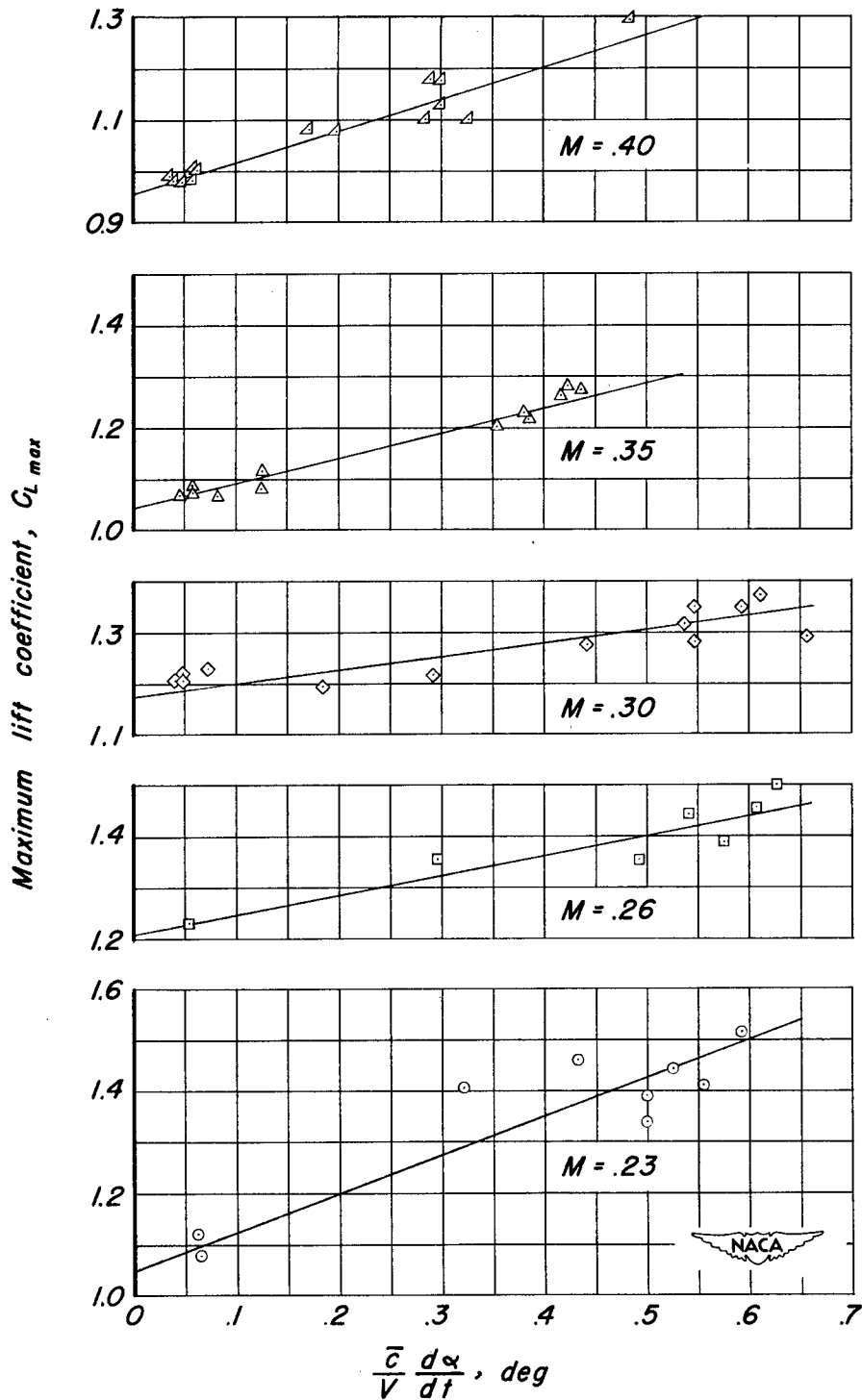

Figure 5.- The effect of rate of change of angle of attack on maximum lift coefficient at 15,000 feet altitude.

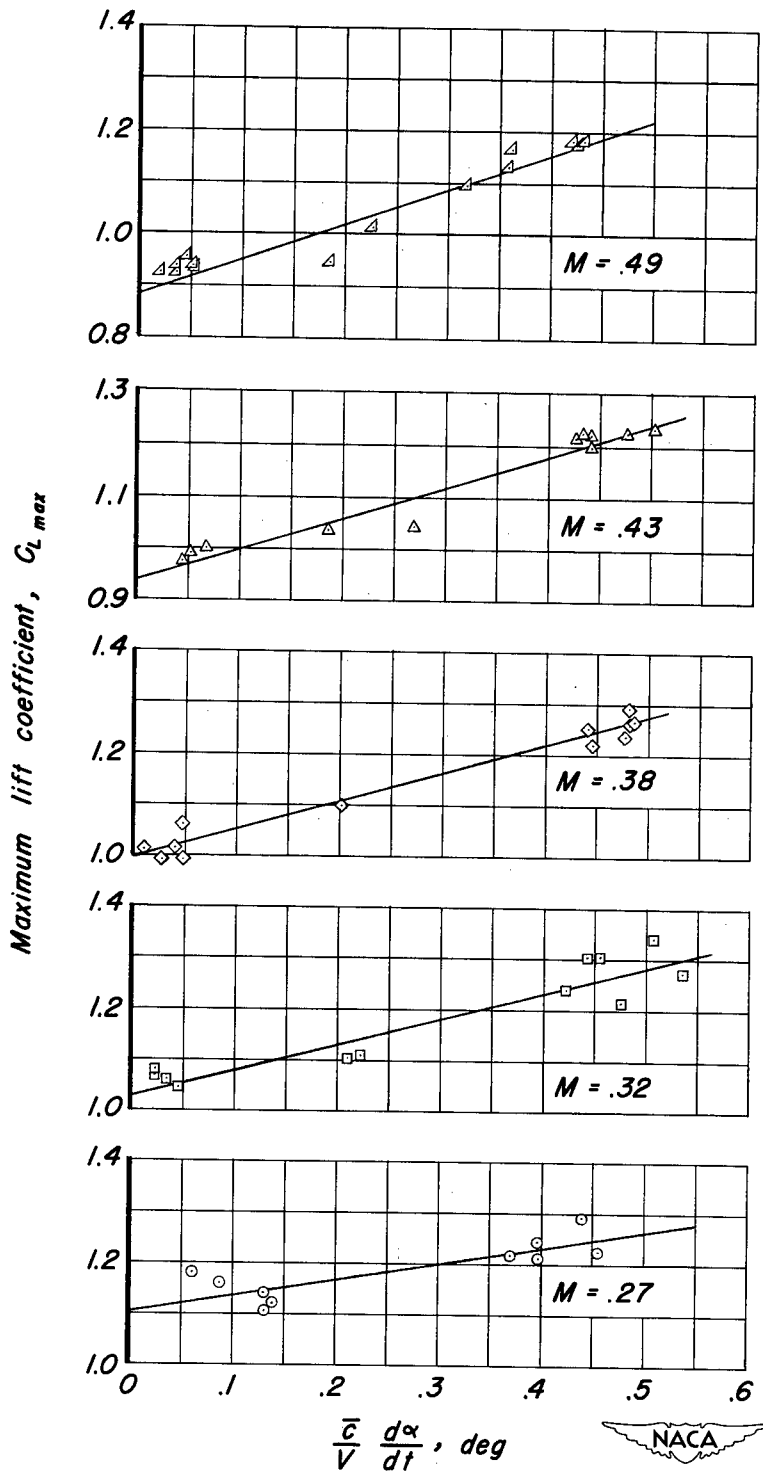

Figure 6.- The effect of rate of change of angle of attack on maximum lift coefficient at 25,000 feet altitude.



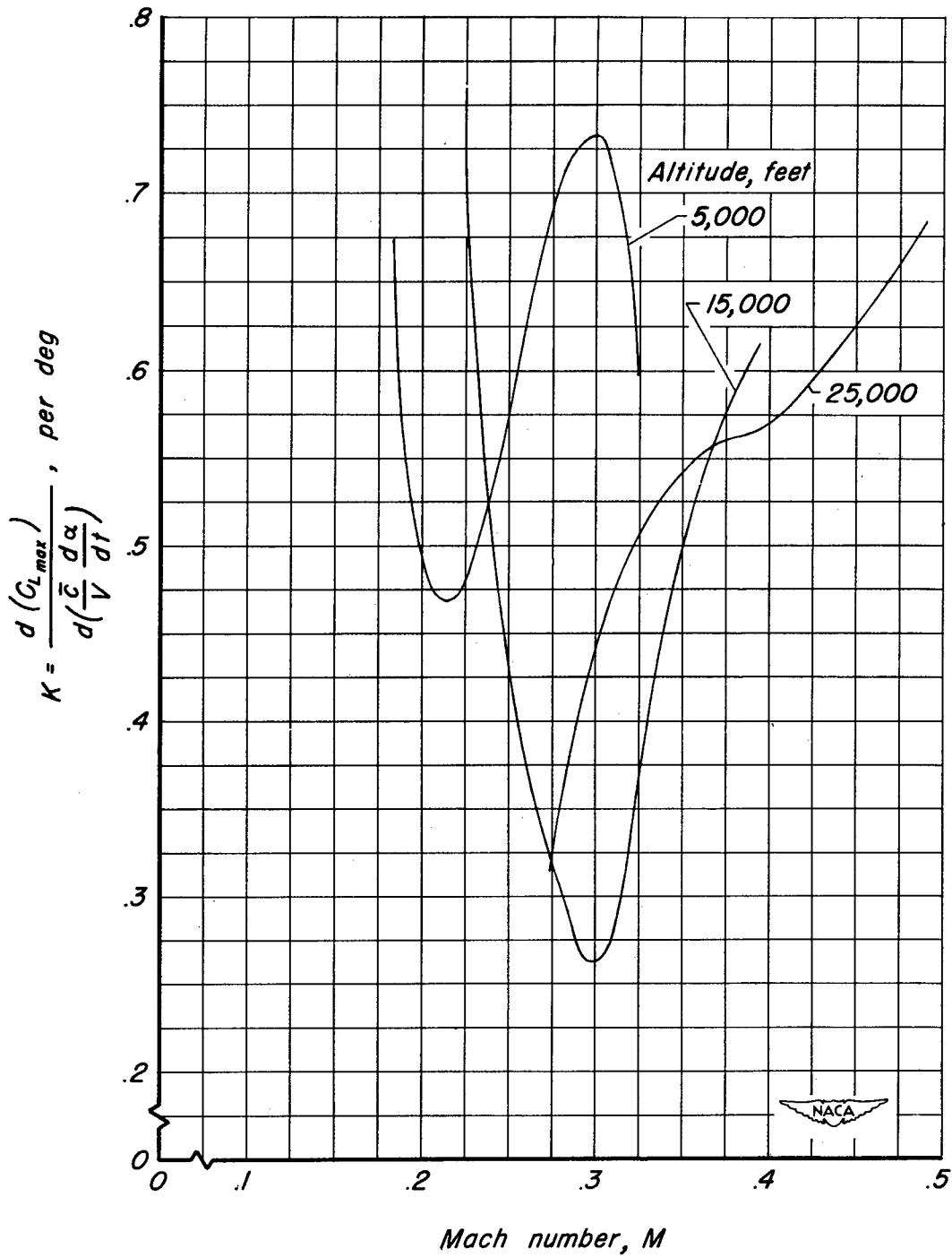

Figure 7.- Variation of K with change in Mach number for various altitudes.

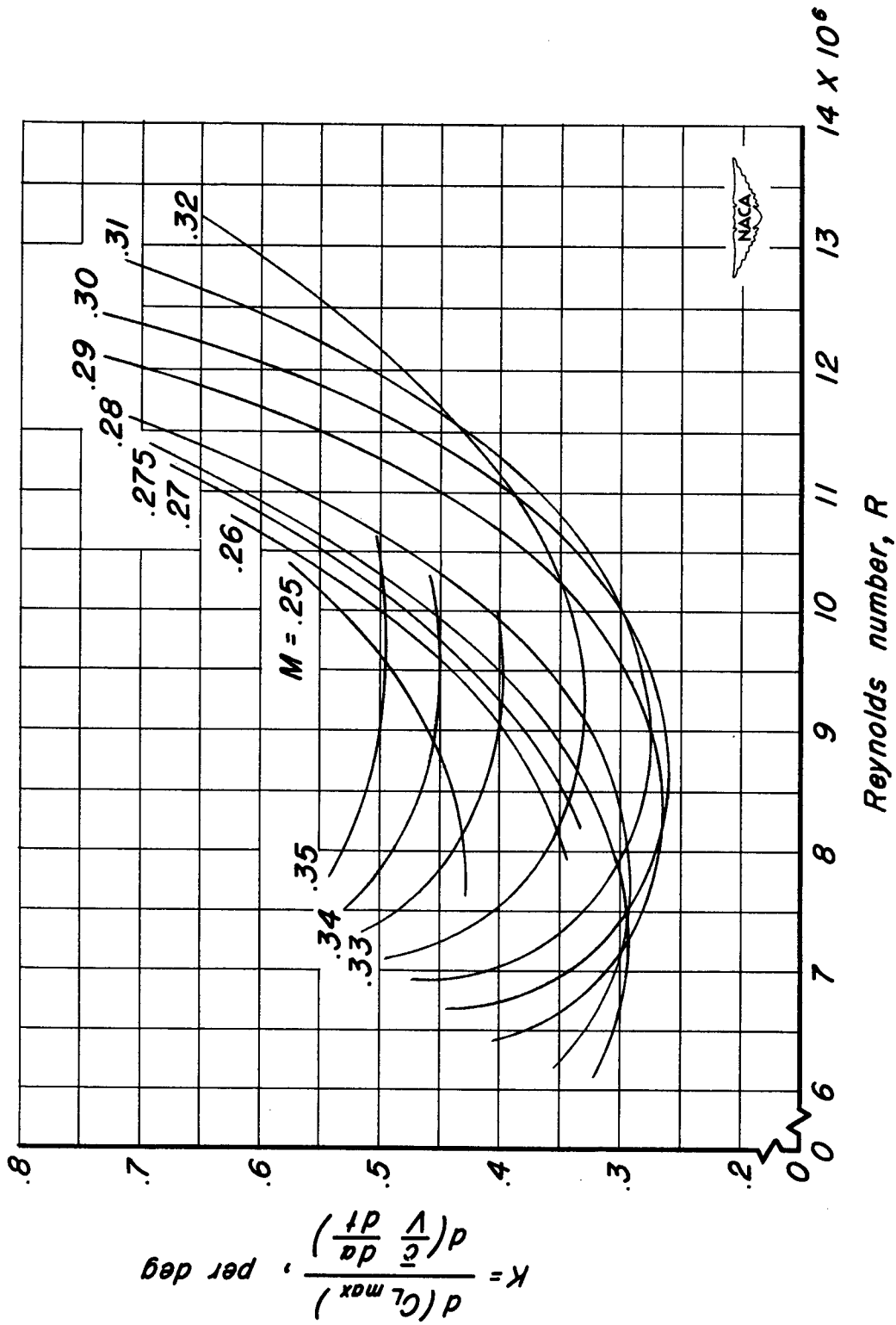

Figure 8.- Variation of K with Reynolds number for various Mach numbers.

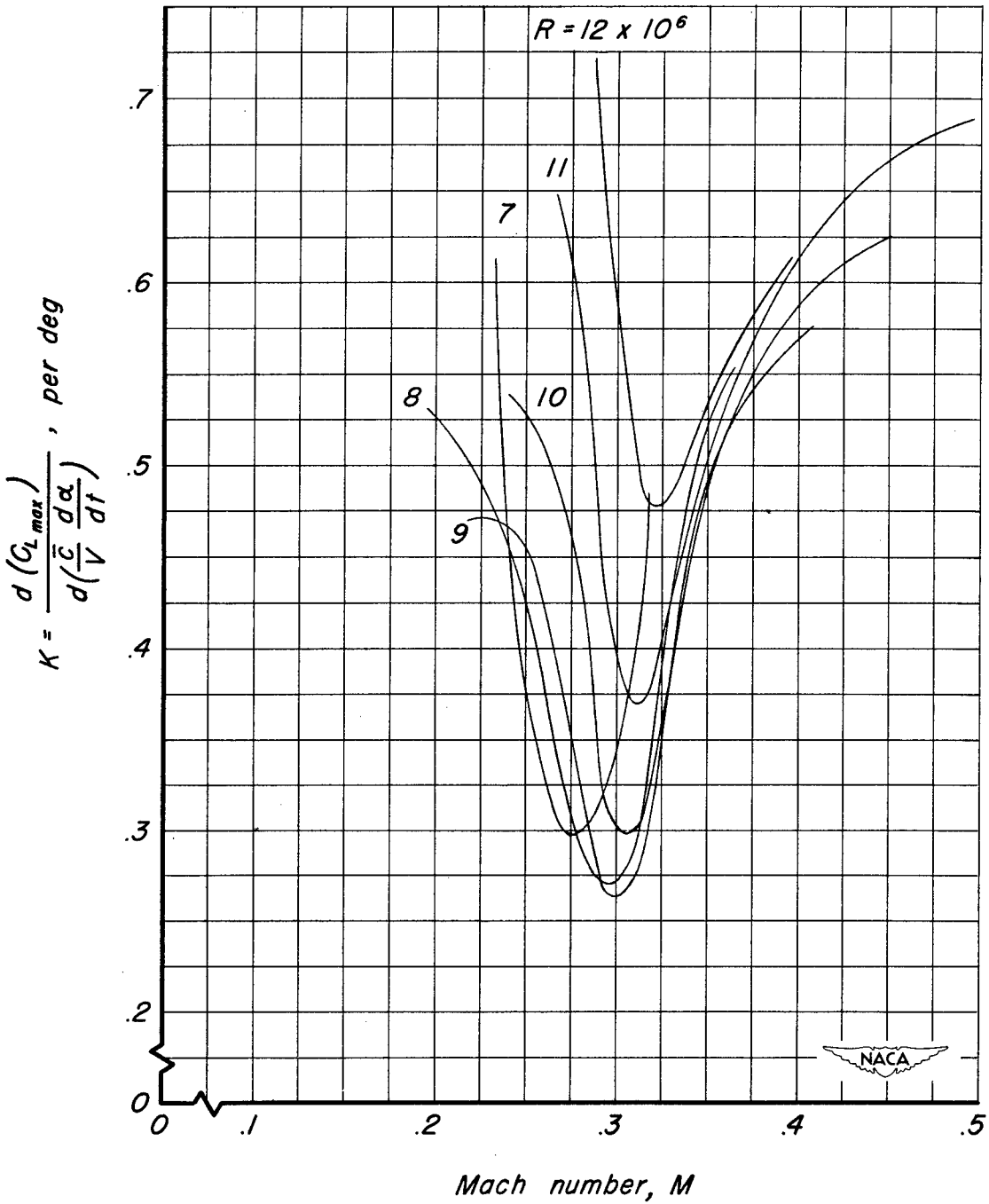

Figure 9.— Variation of K with Mach number for various Reynolds numbers.

NACA TN 2525
National Advisory Committee for Aeronautics.
THE EFFECT OF RATE OF CHANGE OF ANGLE OF
ATTACK ON THE MAXIMUM LIFT COEFFICIENT
OF A PURSUIT AIRPLANE. Burnett L. Gadeberg.
October 1951. 17p. diags., photo. (NACA TN 2525.
Formerly RM A8130)

Flight tests have been made with a pursuit airplane to determine the effect of Mach and Reynolds numbers on the variation of the rate of change of maximum lift coefficient with rate of change of angle of attack. These tests have indicated that the rate of increase of maximum lift coefficient with increasing abruptness of the stall is significantly affected by Reynolds number as well as Mach number. Both parameters reduce this rate of increase over the lower ranges tested and increase it in the higher ranges.

Copies obtainable from NACA, Washington



1. Reynolds Number Effects
- Complete Wings (1.2.2.5)
2. Mach Number Effects -
Complete Wings (1.2.2.6)
3. Airplanes - Specific
Types (1.7.1.2)
4. Stalling (1.8.4)
5. Loads, Maneuvering -
Wings (4.1.1.1.2)
- I. Gadeberg, Burnett L.
- II. NACA TN 2525
- III. NACA RM A8130

NACA TN 2525
National Advisory Committee for Aeronautics.
THE EFFECT OF RATE OF CHANGE OF ANGLE OF
ATTACK ON THE MAXIMUM LIFT COEFFICIENT
OF A PURSUIT AIRPLANE. Burnett L. Gadeberg.
October 1951. 17p. diags., photo. (NACA TN 2525.
Formerly RM A8130)

Flight tests have been made with a pursuit airplane to determine the effect of Mach and Reynolds numbers on the variation of the rate of change of maximum lift coefficient with rate of change of angle of attack. These tests have indicated that the rate of increase of maximum lift coefficient with increasing abruptness of the stall is significantly affected by Reynolds number as well as Mach number. Both parameters reduce this rate of increase over the lower ranges tested and increase it in the higher ranges.

Copies obtainable from NACA, Washington



1. Reynolds Number Effects
- Complete Wings (1.2.2.5)
2. Mach Number Effects -
Complete Wings (1.2.2.6)
3. Airplanes - Specific
Types (1.7.1.2)
4. Stalling (1.8.4)
5. Loads, Maneuvering -
Wings (4.1.1.1.2)
- I. Gadeberg, Burnett L.
- II. NACA TN 2525
- III. NACA RM A8130

NACA TN 2525
National Advisory Committee for Aeronautics.
THE EFFECT OF RATE OF CHANGE OF ANGLE OF
ATTACK ON THE MAXIMUM LIFT COEFFICIENT
OF A PURSUIT AIRPLANE. Burnett L. Gadeberg.
October 1951. 17p. diags., photo. (NACA TN 2525.
Formerly RM A8130)

Flight tests have been made with a pursuit airplane to determine the effect of Mach and Reynolds numbers on the variation of the rate of change of maximum lift coefficient with rate of change of angle of attack. These tests have indicated that the rate of increase of maximum lift coefficient with increasing abruptness of the stall is significantly affected by Reynolds number as well as Mach number. Both parameters reduce this rate of increase over the lower ranges tested and increase it in the higher ranges.

Copies obtainable from NACA, Washington



1. Reynolds Number Effects
- Complete Wings (1.2.2.5)
2. Mach Number Effects -
Complete Wings (1.2.2.6)
3. Airplanes - Specific
Types (1.7.1.2)
4. Stalling (1.8.4)
5. Loads, Maneuvering -
Wings (4.1.1.1.2)
- I. Gadeberg, Burnett L.
- II. NACA TN 2525
- III. NACA RM A8130

NACA TN 2525
National Advisory Committee for Aeronautics.
THE EFFECT OF RATE OF CHANGE OF ANGLE OF
ATTACK ON THE MAXIMUM LIFT COEFFICIENT
OF A PURSUIT AIRPLANE. Burnett L. Gadeberg.
October 1951. 17p. diags., photo. (NACA TN 2525.
Formerly RM A8130)

Flight tests have been made with a pursuit airplane to determine the effect of Mach and Reynolds numbers on the variation of the rate of change of maximum lift coefficient with rate of change of angle of attack. These tests have indicated that the rate of increase of maximum lift coefficient with increasing abruptness of the stall is significantly affected by Reynolds number as well as Mach number. Both parameters reduce this rate of increase over the lower ranges tested and increase it in the higher ranges.

Copies obtainable from NACA, Washington



1. Reynolds Number Effects
- Complete Wings (1.2.2.5)
2. Mach Number Effects -
Complete Wings (1.2.2.6)
3. Airplanes - Specific
Types (1.7.1.2)
4. Stalling (1.8.4)
5. Loads, Maneuvering -
Wings (4.1.1.1.2)
- I. Gadeberg, Burnett L.
- II. NACA TN 2525
- III. NACA RM A8130