

AD652713

Technical Report 75  
JULY, 1960

# Cut-and-Cover Trenching in Snow

D D C  
RECEIVED  
JUN 2 1967  
REGISTRATION  
E



ARCHIVE COPY

DDC AVAILABILITY NOTICE  
DISTRIBUTION OF THIS  
DOCUMENT IS UNLIMITED

  
U. S. ARMY  
SNOW ICE AND PERMAFROST  
RESEARCH ESTABLISHMENT  
*Corps of Engineers*

*Technical Report 76*

JULY, 1960

**Cut-and-Cover  
Trenching  
in Snow**

by **R. W. Waterhouse**

DO NOT WRITE IN THESE SPACES  
EXCEPT FOR THE  
PURPOSES OF THIS  
REPORT

**U. S. ARMY SNOW ICE AND PERMAFROST  
RESEARCH ESTABLISHMENT**  
Corps of Engineers  
Wilmette, Illinois

**Best Available Copy**

## PREFACE

This is a report on one part of Corps of Engineers Greenland Project 13, USA SIPRE Project 22. 2-6. The purpose of the work was to develop and test a technique for making snow-arch covered trenches for use as sub-surface military shelters and communication ways on the Ice Cap. The work was accomplished during 1955 and 1956 by R. W. Waterhouse, civil engineer, Applied Research Branch. Personnel of the First Arctic Engineer Task Force, now the Polar Research and Development Center, provided field support.

This report has been reviewed and approved for publication by the Office of the Chief of Engineers.

  
W. L. NUNESSER  
Colonel, Corps of Engineers  
Director

Manuscript received 9 March 1960  
Department of the Army Project 8-66-02-400

## CONTENTS

|   | Page |
|---|------|
| Preface .....                               | ii   |
| Summary .....                               | iv   |
| Introduction .....                          | 1    |
| Trench cutting .....                        | 1    |
| Trench covering .....                       | 1    |
| Discussion .....                            | 2    |
| Conclusion .....                            | 2    |
| Appendix                                    |      |
| Arch form details.....                      | A1   |
| Principal features, Peter snow miller ..... | A2   |

## ILLUSTRATIONS

| Figure |   |   |
|--------|---|---|
| 1.     | Soft surface cut requires shallow initial inclines .....    | 3 |
| 2.     | Peter snow miller at end of first run .....                 | 3 |
| 3.     | Surface cut .....   | 3 |
| 4.     | Partial cuts .....  | 3 |
| 5.     | Cuts in depth .....   | 4 |
| 6.     | Installing the angle seats .....                            | 4 |
| 7.     | Driving the pins .....                                      | 4 |
| 8.     | Moving arches to edge of trench .....                       | 4 |
| 9.     | Support system.....   | 5 |
| 10.    | Arch in place on tube-pin side .....                        | 5 |
| 11.    | Arch in place on tee-pin side .....                         | 5 |
| 12.    | Arch seated in slotted tube .....                           | 5 |
| 13.    | Installing arches .....                                     | 6 |
| 14.    | Seating arch section .....                                  | 6 |
| 15.    | Installed arches before covering .....                      | 6 |
| 16.    | Top view of trench before covering .....                    | 6 |
| 17.    | Snow miller starting to cover trench .....                  | 7 |
| 18.    | Snow cast from miller .....                                 | 7 |
| 19.    | Snow cover after first run .....                            | 7 |
| 20.    | Trench completely covered .....                             | 7 |
| 21.    | Trench after covering but before stripping .....            | 8 |
| 22.    | Stripping started with 2-ft wide freestanding section ..... | 8 |
| 23.    | Removing the pins .....                                     | 8 |
| 24.    | Removing the angle seats .....                              | 8 |
| 25.    | Snow roof and wall juncture .....                           | 9 |
| 26.    | Snow roof after the arch was removed .....                  | 9 |
| 27.    | Grid painted on snow arch .....                             | 9 |
| 28.    | Completed trench .....                                      | 9 |

#### SUMMARY

During 1955 and 1956 a technique was developed and tested in Greenland for making snow-arch covered trenches designed for use as subsurface military shelters and communication ways on the Ice Cap.

The initial installation consisted of a trench 8 ft wide and 10 ft deep over which an arched snow cover was formed on a removable steel form system. A track-mounted Swiss snow-milling machine driven by a gasoline engine was used in both the trench-cutting and roof forming operations.

Five hundred feet of covered trench was formed and instrumented to gage the time deformation and closure rate of the cavity.

A sequence of photographs are included to show details of the construction technique. The appendix contains details of the snow forms.

## CUT-AND-COVER TRENCHING IN SNOW

by

R. W. Waterhouse

### Introduction

Snow in the accumulation zone of Arctic ice-cap regions has properties which permit its use as a material of construction.

The system described here for producing covered trenches in snow, was developed and tested in Greenland during 1955 and 1956. The site of the testing was on the Ice Cap 220 miles inland and east from Thule, Greenland, at an elevation of 7000 ft. This polar plateau is essentially flat and arid. The accumulating wind-drifted snow has an average mean density of  $0.4 \text{ g/cm}^3$  for the top few feet, and increases in density with depth. During the summer, the sun is continuously above the horizon and air temperatures are rarely above freezing. These general characteristics required the introduction of new trenching concepts.

Photographs in sequence of the cut-and-cover method are included at the end of this brief description to permit study of the details of this technique.

### Trench cutting

The machine used for the trench cutting was a Swiss-made track-mounted milling machine with a rotating drum mounted on the front. Forward motion of the machine on its tracks forces the rotating drum and helical blades into the snow, which is disaggregated and carried by centrifugal action to two ducts over the drum from which it is discharged, guided by adjustable chutes. The cut produced by a single pass of this machine is 8 ft wide and a maximum of 4 ft deep. Repeated passes with the machine enlarged the test trench to its final dimensions.

Precise control was accomplished with this machine except in surface cuts where the high bearing pressure on the tracks, combined with large differences in density and strength of surface snow layers, made vertical control difficult.

The first two cuts in the trench produced an excavation 12 ft wide and 3 ft deep to provide shoulders for the roof in snow much more stable than the surface material. The third and successive cuts of the miller were directed down the middle of the 12 ft wide section, leaving a 2 ft shoulder on each side of the trench.

The forward speed of the miller was reduced by increased density in the deeper cuts. The trenches were cut to a depth of only 10 ft to permit the use of weasels as working platforms during placement of the roof forms.

### Trench covering

The arch support system consisted of steel angles, square tube or tee pins, and slotted tube sections, in which the arch sections were seated. The system was designed to permit rapid installation and stripping of the forms, using only a wrecking bar and/or a 6 lb hammer.

The method of installation consisted of first forcing one leg of the light gage metal angles into the snow wall until the other leg was in contact with the snow. The angles served as load distributors, transferring the arch load from square tube pins inserted into the snow wall through slots in the exposed leg of the angles. The pins in turn supported the slotted tubular sections acting as seats or abutments for the arch sections. Tubes also served as shoes during the assembly, which required forcing the arch into the angle seats. Speed in placing the arch system was essential to avoid damage to the snow walls by melting or closing of the trench by drifting snow. Although the air temperature rarely rose above freezing, the vertical snow walls absorbed enough solar

radiation to start melting in time, producing a deeply honeycombed, fragile snow structure. When increments of 100 ft of roof were in place, the ends were blanked off with plywood sheets, and the miller, traveling parallel to the trench and 30 to 40 ft upwind began backfilling with snow for the arch fill.

During the covering of the arches with Peter snow, the forms were inspected frequently to check for signs of distress in the support system or snow shoulders. When the average crown thickness of the blown snow was about 2 ft, it was permitted to age undisturbed for 24 hr. The deposit of Peter snow remained granular for 20 min to 1 hr, depending on the weather conditions, particularly the temperature. Colder temperatures appeared to arrest the hardening process.

Only one failure occurred in constructing this first 500 ft of covered trench. A 20 ft trench shoulder section in the third 100 ft component collapsed because solar heat had weakened the snow which was further damaged by the miller on backing out of the cut.

The roof of a weasel served as a work stage for stripping the forms which progressed as follows: a. driving the 2-in. square tube pins into the snow until they were flush with the 6 x 6 in. angle seat face; b. levering loose slotted tubes; c. dropping an arch form section at one side; d. removal and stacking of the arch sections; e. removal of the 6 x 6 in. angle and pins remaining in the snow walls.

#### Discussion

During the initial stripping, it was found that considerable shock and mutilation could be sustained by the snow seat as well as the filled arch without apparent detriment to the roof system.

The original form system proved to be easily handled by teams of enlisted personnel, with a minimum of instruction, and it has been successfully used on many occasions since. In fact, the form system and snow arch proved more successful than expected considering that at the time knowledge on the strength properties of either natural or disaggregated snow was limited.

Engineering properties of the snow studied during this operation included the deformation rates of the tunnel section. Many factors, including arch-cover thickness, arch span, and trench depth, influence such deformations. After the plywood was removed, a grid was painted on the end section of the roof to assist in the deformation study.

The current (1960) technique for making cut-and-cover trenches shows no radical changes; however, the hardware has been improved. The Peter millers now in use are larger and more powerful than they were in 1956. Details of hand-placed arch forms, including those now in use may be found in the Appendix. Recent developments include the replacing of the hand-placed hardware with a ski-supported mechanically-articulated form system. Peter snow arches of 16 ft span have been successfully formed.

#### Conclusion

Experience has proved that cut-and-cover trenching by the method described is sound and practical. Undersnow facilities of significant size and durability can be quickly produced by service personnel.



Figure 2. Peter snow miller at end of first run - note drum detail.



Figure 4. Partial cuts must be made.



Figure 1. Soft surface snow requires initial inclines to be shallow.



Figure 3. Three feet of surface snow removed to expose more stable snow for arch support.



## CUT-AND-COVER TRENCHING IN SNOW

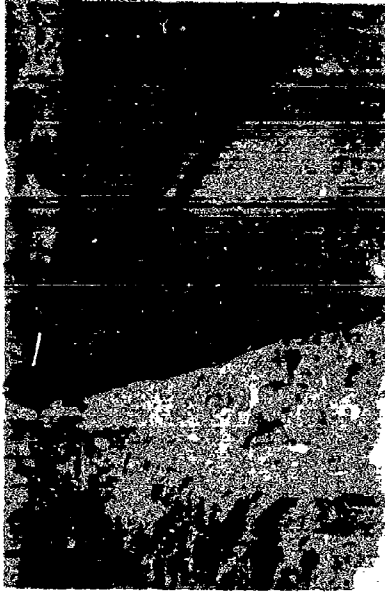

Figure 6. Installing the 6 x 6 in. angle seats from a weasel.



Figure 8. Moving arches to edge of trench for ease in installing.



Figure 5. The third cut leaves foot shoulders on each side of the trench for placement of the arch supports.



Figure 7. Driving the pins to hold the slotted pipe.



Figure 10. Arch in place on tube-pin side.



Figure 12. Arch seated in slotted tube will spread on being loaded.



Figure 9. Support system; alignment is not critical - note sunlight on right wall.



Figure 11. Arch in place on tee-pin side.

CUT-AND-COVER TRENCHING IN SNOW



Figure 14. Seating arch section.

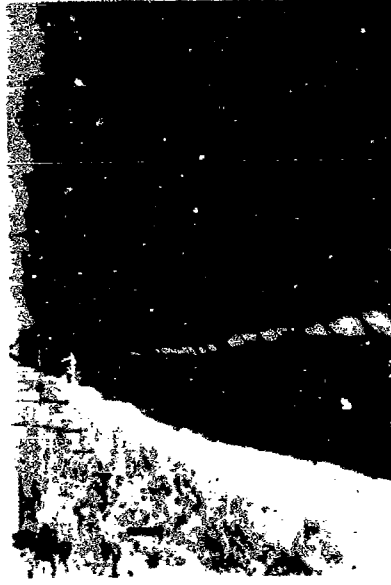

Figure 16. Top view of trench before covering. Arches are installed 100 ft at a time.



Figure 13. Installing arches. Adequate space for weasel travel.



Figure 15. Installed arches before covering. Overlapped corrugations will close when loaded.

CUT-AND-COVER TRENCHING IN SNOW



Figure 18. Snow cast from miller on the upwind side.

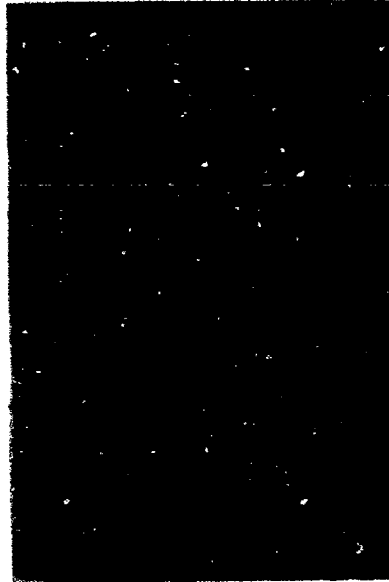

Figure 20. Trench completely covered. Snow will be left undisturbed for 24 hr.



Figure 17. Snow miller starting to cover trench.



Figure 19. Snow cover after first run. Snow is now granular.



Figure 22. Stripping started with 2-ft wide freestanding section.



Figure 24. Removing the 6 x 6 in. angle seats.



Figure 21. Trench after covering but before stripping began.



Figure 23. Removing the pins from the wall.

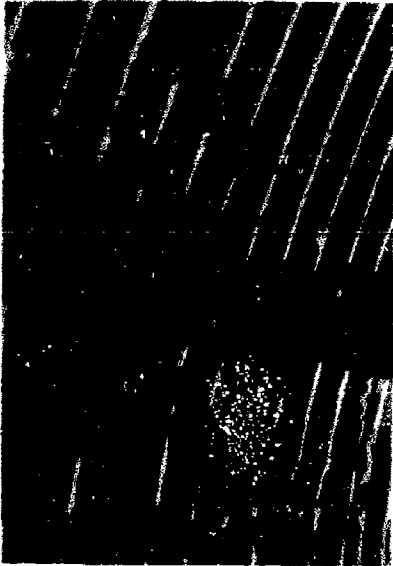

Figure 26. Snow roof after the corrugated arch was removed.

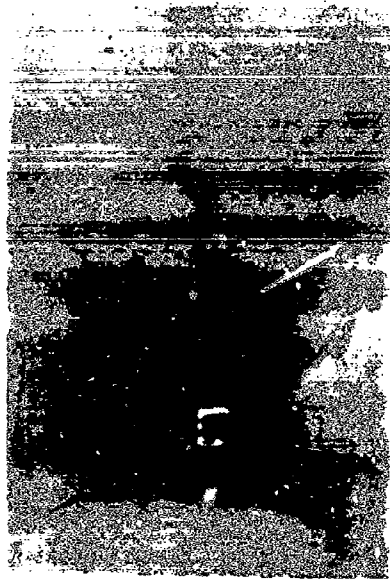

Figure 28. Completed trench after all forms were removed.



Figure 25. Snow roof and wall juncture after the 6 x 6 in. angle seats were removed.



Figure 27. Grid painted on end of snow arch roof for deformation studies.

**BLANK PAGE**

Arch form details

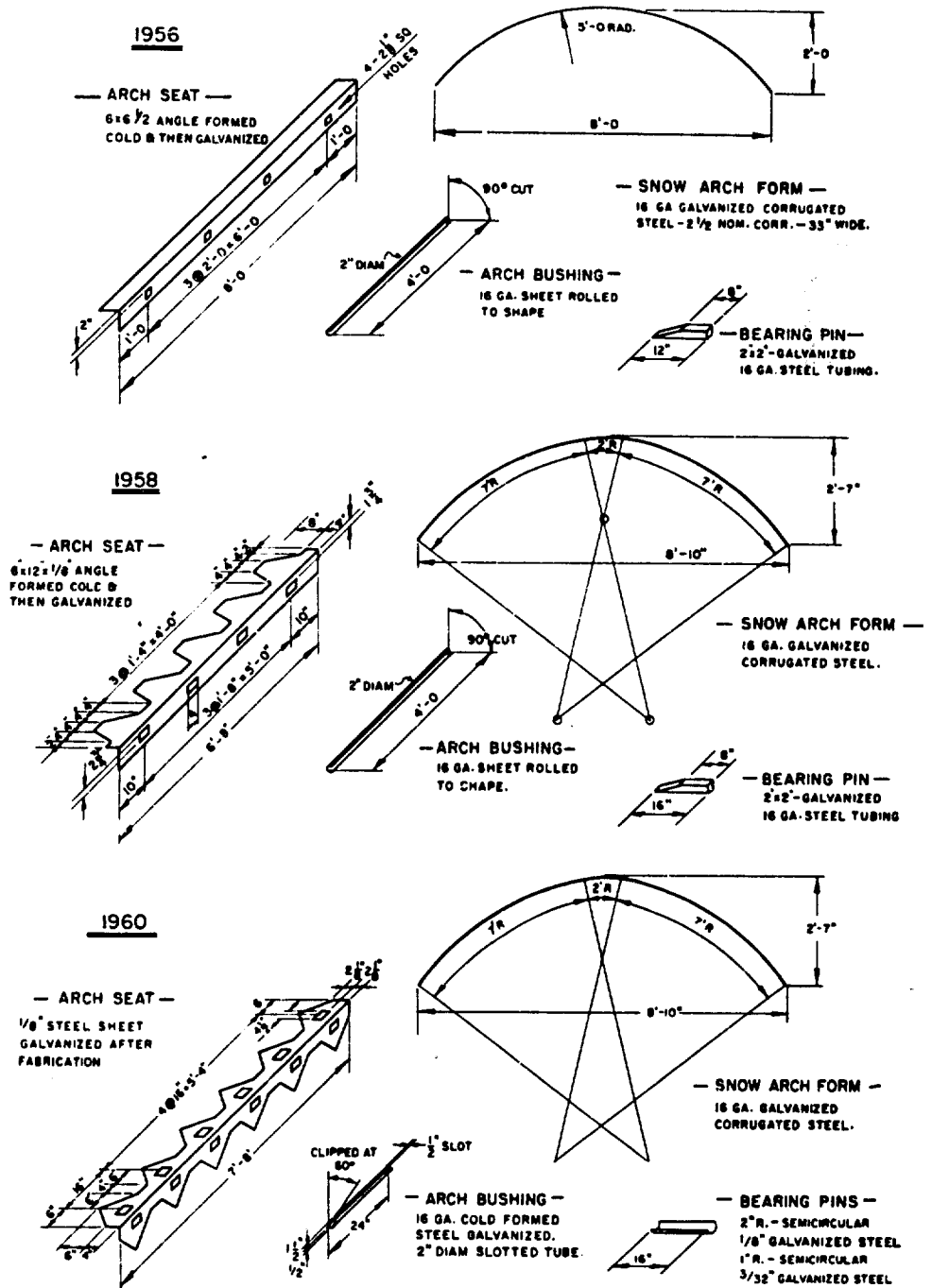



Principal features, Peter snow miller

Manufacturer: Konrad Peter Co., Inc., Liestal, Switzerland

Gross wt: 1200 kg  
Length: 6.30 m  
Width: 2.46 m  
Heigh.: 2.95 m  
Drum diam: 1.2 m  
Drum length: 2.07 m  
Drum speed: 260 rpm  
Power: 2 Ford industrial engines, 100 hp at 2700 rpm  
Drum drive: Geared drive direct from engines  
Track drive: Electric motor 25 hp/track  
Milling speed: 780 yd<sup>3</sup>/hr in 0.4 g/cm<sup>3</sup> snow